

CONTENTS

Contents	I	1
List of Figures	IV	
List of Tables	V	
Abbreviations	VI	
1 Introduction		1
1.1 Existing power systems and power grid infrastructure		1
1.2 Challenges with existing power systems infrastructure		2
1.2.1 Scattered Consumption		2
1.2.2 Limited means of energy storage		3
1.2.3 Network aging factor		3
1.3 Problems in South African power sector		3
1.4 Smart grids		5
1.4.1 Initiatives toward smart grids, budget required and allocated to smart grid research, development, and deployment projects		7
1.4.2 Concerns about smart grids		8
1.5 Benefits of feedback on electricity consumption		10
1.6 Smart meter as a feedback tool		11
1.6.1 Merits and demerits of smart meters		12
1.7 Problem statement		12
1.8 Goals, Constraints, and Scope of the project		13
1.9 Guide to the report		13
2 Demand Response and Demand-Side Energy Management		14
2.1 Introduction		14
2.2 Demand-side Energy Management		14
2.2.1 Types of demand response programs and their effectiveness		16
2.2.1.1 Incentive-based demand response programs		17
2.2.1.1.1 Direct Load Control (DLC)		17
2.2.1.1.2 Interruptible/curtailable rates (I/C Rates)		17
2.2.1.1.3 Demand bidding/buyback programs		18
2.2.1.1.4 Emergency demand response programs (EDRP)		19
2.2.1.1.5 Capacity market programs		19
2.2.1.1.6 Ancillary-service market programs		20
2.2.1.2 Time-based rate/dynamic pricing programs		20
2.2.1.2.1 Time-of-use (TOU) pricing		21
2.2.1.2.2 Critical peak pricing (CPP)		21
2.2.1.2.3 Real-time pricing (RTP)		22

2.2.1.2.3.1	Day-ahead real-time pricing (DA-RTP)	22
2.2.1.2.3.2	Two-part real-time pricing (TP-RTP)	22
2.3	Challenges with the existing demand response strategies	22
2.4	Need for consumer based demand response programs	24
2.4.1	Challenges in deploying consumer based demand response programs	25
2.5	Similar work	26
3	Research Question, Proposed Solution, and Methodology	27
3.1	Introduction	27
3.2	Cell phone: an enabling technology or tool to provide direct feedback	27
3.3	Proposed solution	28
3.4	Research methodology	29
4	Proof of Concept and Implementation	30
4.1	Introduction	30
4.2	System design and implementation	30
4.2.1	Demand-side power measurement system	31
4.2.1.1	Smart socket	31
4.2.1.1.1	Smart socket design considerations	34
4.2.1.1.1.1	Backhaul interface	34
4.2.1.1.1.2	Current measuring unit	34
4.2.1.1.2	Smart socket advantages	34
4.2.1.1.2.1	Easy to install	34
4.2.1.1.2.2	Cost effective	34
4.2.1.1.2.3	Flexible	34
4.2.1.1.2.4	Extendable in functionality	35
4.2.1.2	Smart socket controller	35
4.2.1.3	ADSL modem	35
4.2.2	Demand-side control system	35
4.2.2.1	Web service interface	36
4.2.2.2	Database management	36
4.2.2.3	Database	36
4.2.2.4	Authentication management	36
4.2.2.5	Demand-side management policies	37
4.2.3	Consumer mobile terminal	37
4.3	Experimentation	37
4.3.1	First week of experiment	38
4.3.2	Second week of experiment	38
4.3.3	Third week of experiment	38
5	Results	40
5.1	Introduction	40
5.2	Findings week one	40
5.3	Findings week two	41
5.4	Findings week three	43

5.5	Discussion and performance analysis	44
5.5.1	Analysis with respect to consumption	45
5.5.2	Analysis with respect to price	47
5.5.3	Analysis with respect to alert/response log	48
5.5.4	Recommendations for the electricity utilities	49
6	Conclusion and Future Work	50
6.1	Future work recommendations	51
7	References	52

LIST OF FIGURES

Figure 1: Traditional power systems paradigm 2

Figure 2: Abstract system diagram 28

Figure 3: Physical and Logical system diagram 31

Figure 4: Smart Socket Circuit Diagram 32

Figure 5: Smart Socket Snapshots 33

Figure 6: Week 1 - Percentage of consumption breakdown during peak time and off-peak time of electrical energy demand 41

Figure 7: Week 2 –Percentage of consumption breakdown during peak time and off-peak time of electrical energy demand 43

Figure 8: Week 3 - Percentage of consumption breakdown during peak time and off-peak time of electrical energy demand 44

Figure 9: Summary of findings for all three weeks (with respect to consumption) 45

LIST OF TABLES

Table 1: Eskom’s current generation capacity based on their power generation houses	4
Table 2: Types of feedback and their effectiveness	11
Table 3: Existing demand response strategies	24
Table 4: Findings week one	40
Table 5: Findings week two	42
Table 6: Findings week three	43
Table 7: Summary of findings for all three weeks	44
Table 8: Performance Analysis	46
Table 9: Alert/response log	48

ABBREVIATIONS

MW	Megawatts
GW	Gig watts
IEA	International Energy Agency
JCERDC	Joint Clean Energy Research and Development Center
CPUS	California Public Utilities Commission
SGSC	Smart Grid, Smart City
MEREGIO	The Minimum Emission Region Project
IISM	Institute of Information Systems and Management
DOE	Department of Energy
VHS	Video Home System
HAN	Home Area Network
EPRI	Electric Power Research Institute
DSM	Demand-side Management
EE	Energy Efficiency
EC	Energy Conservation
DR	Demand Response
FERC	Federal Regulatory Commission
DLC	Direct Load Control
I/C Rates	Interruptible/Curtailable rates
EDRP	Emergency Demand Response Programs
NYISO	New York Independent System Operator
TOU	Time-of-use
CPP	Critical Peak Pricing

TR-RTP	Two-part Real-time Pricing
ICT	Information Communication Technology
AMR	Automatic/Automated Meter Reading
PLC	Power Line Communication
GSM	Global System for Mobile Communication
GPRS	General Packet Radio Service
ADSL	Asymmetric Digital Subscriber Line
3G	Third Wireless Network Generation
R	RAND (Currency)
SMS	Short Message Service
ON	Switch the electrical appliance ON
OFF	Switch the electrical appliance OFF
CT	Current Transformer
AC	Alternating Current
DC	Direct Current
uF	Microfarad
XML	Extensible Markup Language
HTTP	Hypertext Transfer Protocol
LSEs	Load-serving Entities

1 Introduction

Electricity has become important in modern human life. Its invention and development roots came from the mid-17th Century [1]. In the 21st Century we are very much dependent on electricity not only in our daily life but also to support industrial development.

1.1 Existing power systems and power grid infrastructure

Electrical grid systems have been made through incremental innovations from the 19th century [2]. These century-old power grids based on 19th century's paradigm span large areas of the Earth and are huge interconnected machines. They are massively complex and are inextricably linked to social and economic activity [3]. In the past these grids were predominantly based on large central power stations connected to high voltage transmission systems which in turn, supply power to medium and low-voltage local distribution systems (such as towns and cities) as shown in Fig. 1.1. This existing power grid infrastructure supports only one direction of information flow, namely network-level control signals. At the same time energy flows from the grid to the consumer only. These existing transmission and distribution systems all over the world use technologies and systems that are many decades old. They also make limited use of digital communication, and control technologies [4].

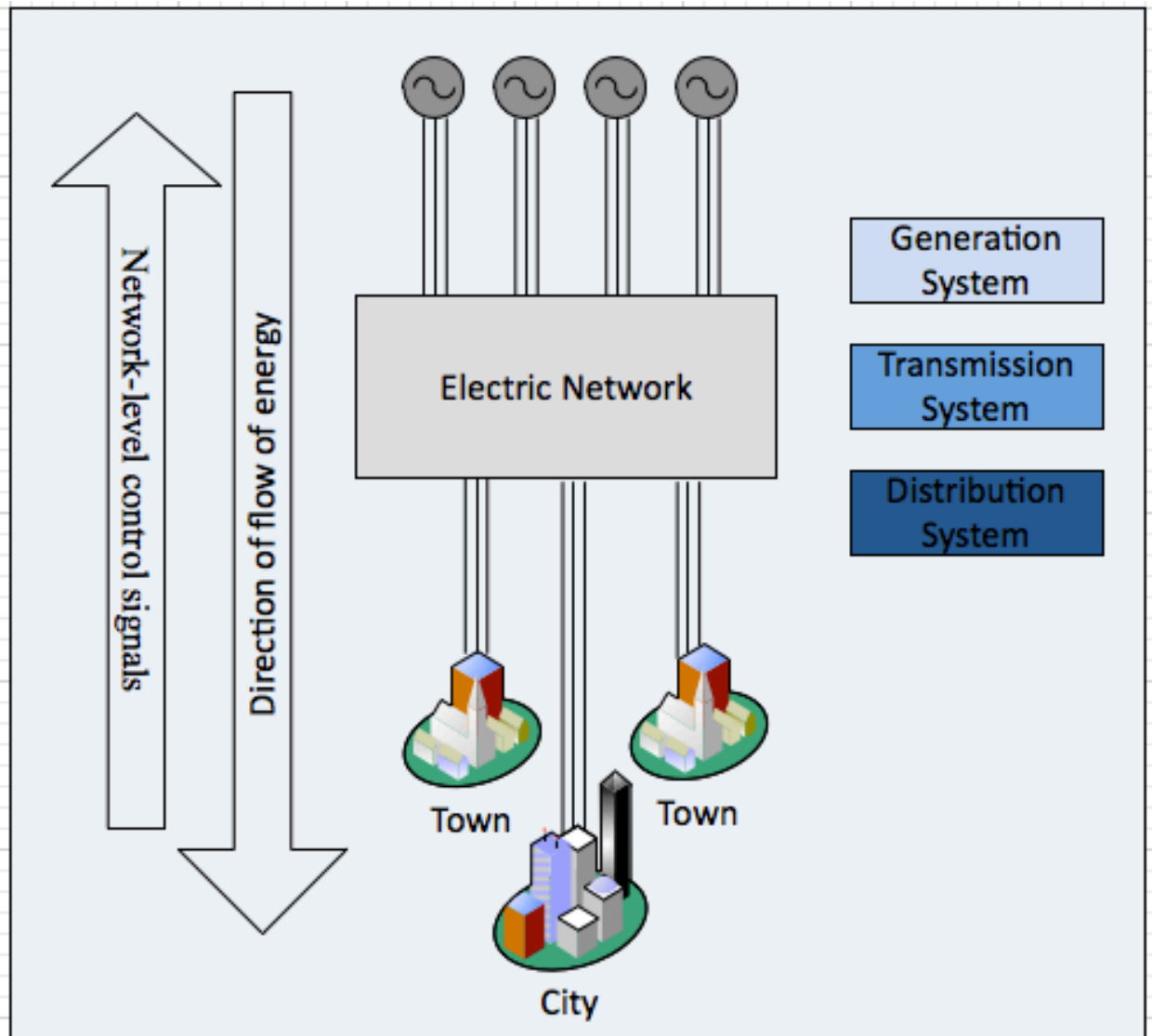

Figure 1: Traditional power systems paradigm

1.2 Challenges with existing power systems infrastructure

1.2.1 Scattered Consumption

Unlike power generation, energy consumption is generally scattered or dispersed over a given territory [2]. This adds an overhead that brings a need to have longer power transmission systems. The transmission systems are a cause of electrical losses because of their aging process and the length of the transmission system.

1.2.2 Limited means of energy storage

Electrical energy is very difficult to store in sufficient quantities to be able to meet an instantaneous demand at a given time. Batteries, capacitors, pumped storage, or flywheels are the only common means that are currently used to store electrical energy in usable form. In spite of the important progress made in the technology of these devices, it is not possible to use them to store a sufficient amount of energy to deliver in a quasi-immediate way a power of several megawatts (MW) [2].

1.2.3 Network aging factor

The transmission and distribution networks are essential components in a power system. These components, at every moment, have the task of keeping the balance between electrical power generation and its consumption by all the electricity consumers connected to the system [2]. Since the current technologies and grid infrastructures across the World are old, it is noticed that there are considerable energy losses because of the aging factor of these networks. These losses occur during the transmission and distribution of electrical energy across these networks.

1.3 Problems in South African power sector

In the year 2000 worldwide gross installed power generation capacity increased from 3000 GW to 3750 GW. This generation capacity is further expected to reach 6000 GW by the year 2020. Most of this increase will be in developing countries. Africa that covers 15% of the earth's land area, and has 13% of the world's population, consumes 3% of its electricity. Africa only accounts for 2% of global industrial capacity. Africa has an installed electricity generation capacity of approximately 103GW [9].

Table 1: Eskom's current generation capacity based on their power generation houses [12]

Eskom's power stations 2008			
Baseload	Capacity (MW)	Others	Capacity (MW)
<i>Coal-fired</i>		<i>Hydro</i>	
Arnot	2,100	Gariep	360
Duvha	3,600	Vanderkloof	240
Hendrina	2,000	<i>Hydro distribution</i>	
Kendal	4,116	First Falls	6.4
Kriel	3,000	Second Falls	11.0
Lethabo	3,708	Colley Wobbles	42.0
Majuba	4,110	Ncora	24.0
Matimba	3,990	<i>Pumped Storage</i>	
Matla	3,600	Drakensberg	1,000
Tutuka	3,654	Palmiet	400
<i>New Build (coal)</i>		Ingula (new build)	1, 332
Medupi	4,788	<i>Open cycle gas turbine</i>	
<i>Brought-back-to commission</i>		Acacia	171
Camden	1,600	Port Rex	171
Grootvlei	1,200	Ankerlig	592
Komati	1,000	Gourikwa	444
<i>Nuclear</i>		Gas I (new build)	1,036
Koeberg	1,930	<i>Wind</i>	
		Klipheuwel	3.2
Total Baseload	44, 396	Total Other	5,833
Coal share of total cap	42,466	Total Overall Capacity	50,229

The South African economy relies heavily on its large-scale energy-intensive mining industry. Therefore, electricity plays a very critical role in South Africa's economy. As explained in [9], electricity demand in South Africa and other developing economies is expected to increase significantly by 2020. This rise in demand requires a significant expansion in both generation and transmission infrastructure. Assuming an S-curve phenomenon the maximum demand in South Africa by the year 2020 could be anything between 38 GW to 58GW [10]. Eskom is the tenth largest electricity company in the world in terms of its generating capacity and controls the largest generation and transmission infrastructure in South Africa. It generates approximately 95% of South African electricity, and 45% of the electricity consumed on the African continent [11]. Eskom generates 85% of its total electricity from coal powered generation resources [12]. In recent years South Africa has experienced a shortfall of electricity due to several reasons. Eskom's current overall generation capacity is 50.2 GW (*The breakdown of this is presented in Table 1*). South Africa exports electricity to some neighbouring countries that has also been affected by the gap between power generation and consumption curves in South African

electricity market. Eskom is now busy constructing new power stations and bringing back into commission those that were mothballed. Once operational they should add another 17 GW by 2014. But South Africans have been warned that during this period occasional blackouts may occur [13]. It is obvious from different reports that Eskom will have to continue with these rationing policies at least for the next few years. However, the possibility exists to reduce power rationing by saving on the wasteful use of electricity

1.4 Smart grids

The future form of the electric power grid is the “smart grid”. The concept of the smart grid aims to bring in the features such as secure and consistent, efficient and cost effective, renewable and green, open and integrated and so on. As discussed in [5] smart grid is an innovative type of power grid that integrates advanced techniques such as information management, data communication techniques, physical grid infrastructure technologies and computer science theories in order to make the grid operations robust. It brings in many advantages such as improved electrical energy efficiency, reducing carbon emissions to the air, improving the reliability and security of the electrical power system and minimizing the power losses over the transmission and distribution system. Some of the characteristics of smart grid are explained as follows [5]:

- **Secure and reliable:** It is very important to ensure that the new power grid operates securely and reliably. Power outages, faults, natural disasters, and extreme weather conditions need to be addressed when designing new infrastructure for smart grids.
- **Efficient and economical benefits:** With use of improved technology, innovation, and energy efficient management the power grid can improve economic benefits. The use of advanced technology supports the electricity market and power transactions effectively to achieve the rational allocation of resources. This can reduce power losses and finally helps in improving the efficiency of energy.
- **Clean and green:** Smart grid concept facilitates the integration of large-scale renewable energy sources. These renewable energy sources can be fed into the grid infrastructure that will help in reducing the potential impact on the environment.
- **Optimization:** The concept of smart grid is to improve power supply reliability and security to meet the electrical energy demand in the digital arena. From the utility’s viewpoint the concept of smart grid can optimize utilization of assets, reduce the investment costs and operation and maintenance costs.
- **Interactive:** The new smart grid infrastructure has a real-time interactive response between electricity utilities and electrical energy consumers. This interaction can provide ways to enable electrical energy consumers to participate in grid operations resulting in reliable grid functionality.
- **Self-healing:** Smart grid works on predictive rather than reactive principles. This prediction enables the grid control system to do on-line security assessment and analysis, powerful control systems for early warnings and prevention control, automated fault detection and diagnosis, and system self-recovery capability. This self-healing and adaptive nature of the system helps correcting problems before they become a threat.

- **Flexible and Compatible:** The new form of power grid can support different forms of renewable energy sources. It is also suitable and compatible for integration of micro power grids. Integration of all these distributed and renewable sources into the grid system can improve and enhance the function of demand side management to achieve efficient interaction with users.

San Diego Smart Grid Study Final Report [14] is a good text about smart grid. It explains some more conceptual details about the idea of smart grid. It also elaborates some key success factors about the smart grid design and its implementation. They assume that their smart grid design will be able to address the following issues [14]:

- Identify and report the expected emerging problems before they impact the system
- Monitor the system from a broader perspective and manage the system-wide inputs
- Centralized advanced automated systems with help of rapid communication will be able to control and stabilize the system quickly in case of an interruption
- Re-route power flows, change load patterns, improve voltage profiles, and take other corrective steps within seconds of detecting a problem.
- Makes it possible to bring distributed generation resources into the system
- System reliability and security is the key factor
- Gives the system operator more control over the system
- Maximum utilization of assets available.

The project team at San Diego Smart Grid project [14] outlines the following benefits coming out of their smart grid project:

- Automated system operations will help to reduce the system operational cost
- Fewer system-wide power outages and local power disruptions
- Faster recovery from a power disruption situation
- Greater security
- Real-time monitoring and actions based on that real-time information
- High quality power
- Enable consumer to change their consumption patterns as per their very own requirements, this eventually helps them to manage their cost.

Comparing different available texts [2, 14] explaining the concept of smart grid one can summarize it as a modern form of electricity power network (grid) that is based on digital technology. It integrates distributed generation resources into the system and helps to keep this system stable. Smart grid also makes it possible to provide electricity users with the details of their electricity usage profile using bi-directional flow of information. This can then enable users to change and sometimes improve their electricity usage profile and hence, to cut down their electricity usage costs. Furthermore, smart grid can help to virtually eliminate power outages or

ensure a quick recovery from a disruption because of its self-healing behaviour. It improves system losses and enables the system operators to provide more reliable and quality power. With the help of distributed generation resources (which are mainly solar and wind based resources) it also reduces the environmental impacts.

1.4.1 Initiatives toward smart grids, budget required and allocated to smart grid research, development, and deployment projects

According to the International Energy Agency (IEA), global investment in the energy sector for the year 2003 – 2030 is around \$ 16 trillion. Only in Europe an investment of some 500 billion Euros are estimated to upgrade the European electricity transmission and distribution systems [4].

The American Recovery Act in clean energy included more than \$80 billion for the research and development of renewable energy sources, expanding manufacturing capacity for green energy technology, improving vehicle and fuel technologies, and building complex, better, reliable, and smart electricity networks (grids) for the U.S. [16]. The objectives of this project are to reduce power interruptions and outages that cost American electricity consumers about \$150 billion a year. With the help of such an intelligent grid each American citizen will be able to save \$500 a year. This is also to put Americans on the path to generate 20 percent or more of their energy from renewable or green sources by 2020 [15].

As part of the U.S and Indian partnership in Advance Clean Energy the US department of Energy has announced a research fund of \$25 million over the next five years to support the U.S-India Joint Clean Energy Research and Development Center (JCERDC) [17]. Initially the focus of this research center will be in building energy efficiency, second-generation biofuels, and solar energy.

Automated meter reading or advance metering is the basic enabling component in a smart grid environment. California Public Utilities Commission (CPUC) started a policy in 2003 to make sure that all the electricity consumers have advanced meters. In 2006 California launched a statewide rollout of advance meters in collaboration with three large investor-owned utilities. Pacific Gas & Electric will be installing 5.1 million smart meters at a cost of \$1.7 billion. Their deployment schedule is from 2006 to 2012. San Diego Gas and Electric will be installing 1.4 million smart meters at a cost of \$0.6 billion. Their deployment schedule is from 2008 to 2011. Southern California Edison will be installing 5.3 Million smart meters at a cost of \$1.7 Billion. Their deployment schedule is from 2009 to 2012 [18].

Australia is also an active player towards its transformation to the digital grid. Australian Government is currently investing about \$100 million for their smart grid demonstration project under the Smart Grid, Smart City (SGSC) program. This fund is being used on research and

development for the Australian smart grid projects. The specific research areas under this program are Smart meter systems and consumer engagement, Control systems for networks, Grid security measures and systems, and Policy and regulatory settings [19].

The minimum Emission Region Project (MEREGIO) at the Institute of Information Systems and Management (IISM) in Germany is focusing on developing a test region in the Southwest part of Germany [20]. The project objective is to reduce the carbon footprints of the region as much as possible. This is a test bed for verifying the technologies required to deploy a fully functional smart grid. To achieve such goals consumers in the region will be equipped with advanced information and communication technologies and smart devices.

Other developed and developing countries including Argentina, Austria, Sweden, Canada, China, South Korea, Italy, Spain, South Africa, Malta, France, United Kingdom, and many more are also investing in research and development of their prospective smart electricity networks [21, 22]. Most of these projects are based on Advanced Metering Infrastructure, which is one of the most important enabling technologies in a smart grid environment.

1.4.2 Concerns about smart grids

Transformation to the smart grid infrastructure is a major shift. Such huge transfers of technology come with a lot of challenges, and smart grid is no exception. Department of Energy's (DOE) National Energy Technology Laboratory report, a systems view of the modern grid [23], a report by IBM on building the World's first national smart utility grid [24], and Eric Lightner and Rich Scheer's research about "Moving from Concept to Reality, The Smart Grid Will Revolutionize The Way People Buy, Sell, and Use Electricity" [25] highlights the main concerns or challenges about deploying a fully functional smart grid infrastructure. These are:

- **Policy and Regulation:** Utilities and regulators often take a close-minded approach or model for new construction projects. Smart grid is no exception for most of the regulatory organizations. Smart grid has also not proven its operational benefits as yet. This makes it difficult to encourage utilities to make huge investment for such projects. There has to be a very clear policy or regulations outline for all the parties involved or will be benefitting from a fully functional smart grid.
- **Worries about a smart grid betamax:** Eric Lightner and Rich Scheer's article [25] quotes that Suedeen Kelly has pointed out his worries about the smart grid Betamax. The author explains that in the US "there are 70 utilities in 33 states working on pilot projects related to advanced meters. Not all of these projects necessarily would fit within the definition of Smart Grid technologies, but clearly a lot of development is under way. With that, comes the concern about the ability of the technologies being tested to communicate with one another, says the commissioner for the Federal Energy Regulatory Commission. Lacking that ability, we could end up with modernized pockets of the grid,

with one area operating on the equivalent of Betamax technology and the other running VHS” [25].

- **Lack of standards:** Many industry partners and research organizations today are working on technologies and components that will help in transformation of the existing grid into the digital arena of smart grid. With the advancement in information systems, communication technologies, and control engineering theories it is possible to manage our electrical systems in a more efficient way. It can help to use electricity in an efficient manner and also bring distributed generation resources (such as solar systems, wind generation systems and so on) into the system. To make such a complex system work we need to work in an integrated system manner. To achieve this we require standards for interfacing different technology blocks together. Standard developing organizations such as IEEE and others need to bring together all the stockholders to define these standards.
- **Financial requirements:** Because of the social benefits of the smart grid its business case sounds good on paper. But it requires extensive tests and proofs of technology before major investments are made.
- **Smart appliance:** “*Will the consumers be willing to replace their current electronic appliances with the smarter appliances?*” becomes a very important question. “Intelligent appliances” or smarter appliances are appliances that can tune themselves according to the tariff information received from the grid operator. Existing electronic appliances might not be compatible with the digital grid. This may come as a challenge for the utilities and regulators.
- **Cost of installing consumption-monitoring equipment:** Experience in the Malta Smart Grid project has proven that technologies involved to deploy smart grid are expensive. The cost of installing advanced meters and some of the other required equipment and infrastructure has been about \$360 per consumer (derived from data provided in [24]).
- **Speed of Technology Development:** Many experts in the field have expressed their concerns over the maturity and reliability of Smart Grid enabling technologies. Engineers and scientist predicted about 50 years ago that solar energy, the basement fuel cell, and chimney wind generators would be part of modern age houses. Most of these technologies have not yet been incorporated into a form where a common household can afford and make use of them. For a fully functional and reliable smart grid project the speed of development of these technologies requires to be increased.
- **Energy storage technologies:** Energy storage technologies are also not very reliable. Battery technologies need to be improved to store electricity for longer period of time. Technology also needs to be improved to increase the life span of a battery.
- **Financial support from the governments:** The financial requirements for the smart grid projects are intensive. Electricity service providers (utilities) in most of the countries might not have financial capacity to deploy a smart grid project. Government needs to help industries in order to support smart grid initiatives.

1.5 Benefits of feedback on electricity consumption

Governments and power utilities are investing significant amounts of money for the research and development of smart grid projects. The expected outcome of all these projects is to achieve reliable and better quality power. The objective is also to bring more and more renewable distributed energy generation sources into the electrical grid. This will help to generate carbon free energy and also will ensure that the environment is clean. Consumers will also have more control about their electricity consumption.

Sarah Darby [26] in her literature survey on metering, billing, and direct displays mentions that domestic energy consumption information is still invisible to millions of the domestic consumers. This is the one of the main reasons for the waste of electrical energy. Dobbyn and Thomas [27] explains it with an interesting incident, “*We cannot be using that much... it’s just the two of us in this two-bed flat. I am out all day...and we are on income support. I just don’t know how the bills are so high... I think there is something wrong with them.*” - Londoner in her 30s, whilst in broad daylight lights were on in most rooms, a TV and radio were playing in an unoccupied bedroom, and all appliances in the sitting room were on standby [27].

There are substantial improvements noticed when the feedback about electricity consumption was provided to the consumers. Domestic consumers are found responsive when they were provided with this information [26]. Table 2 shows the results of the survey on how users are able to save their electricity when they are provided with the consumption information through different sources. Direct feedback has a benefit ranged from 5 – 10%. This sort of feedback was provided on a smarter kind of device where consumer can read it while (s)he is around. Such displays were mounted on the walls in the kitchens or other relatively well visible areas inside a house.

Table 2: Types of feedback and their effectiveness

No	Type of feedback	Electricity saved
1	Direct feedback (immediate, from the meter or an associated display monitor)	5 – 10%
2	Indirect feedback (feedback that has been processed in some way before reaching the consumers, normally via billing)	0 – 10%
3	Historic feedback (comparing with previous recorded periods of consumptions)	0 – 10%

Study in [28] outlines the circumstances where feedback was found more effective:

- When information about the electricity consumption is provided frequently, as soon after the consumption behaviour as possible,
- When it is clearly and simply presented,
- When it is customized to the household's specific circumstances,
- When it is provided relative to a meaningful standard of comparison,
- When it is provided over an extended period of time,
- When it includes appliance-specific consumption breakdown (some studies),
- When it is interactive (some studies).

1.6 Smart meter as a feedback tool

Smart electricity meters are equipped with advance digital technologies that can monitor electricity consumption information in more detail than an interval meter or an accumulation meter [29]. Smart meters often come with a capability of one –way or two-way communication between the electricity consumer and the utility operators. Ability to provide bidirectional data communication enables electricity utilities to offer their consumers with more detail about their electricity consumption profiles. This also enables utilities to offer time-based tariffs to their consumers [30]. Such real-time monitoring feature makes it possible to control the electrical energy consumption during the peak-time of electricity demand.

1.6.1 Merits and demerits of smart meters

- **Cost of deployment:** Smart meters at present are very expensive to install. It requires deployment of expensive hardware fitted in a lot of homes by trained personnel [6].
- **Technology requirements:** A smart meter operational system requires advanced and sophisticated software systems. The systems also need to be integrated with the legacy IT systems. There is no communication infrastructure at present for supporting communication in real time for smart meters. The technologies that are currently being deployed will be very different from those that will be available in ten years' time. But the meters that are going out now have no way of being upgraded in a cost efficient manner. This makes it challenging for the return on the investment for smart meters. Besides all these challenges we do not know if smart meter will be the only interface to the electrical energy consumers homes in future. Considering smart home architecture every electrical appliance is capable of communicating via the Home Area Network (HAN). The smart meter in these cases need to be able to identify specific appliances on this HAN [6].
- **Time of information:** To benefit from the data generated by modern smart meters is useful only if it is acquired in a timely fashion. This data also needs to be stored accurately for future usage by different parties. "A multitude of control algorithms to improve the reliability and optimization of the energy delivery network can be derived from the collected data generated by the smart meters" [7,28].
- **Inefficient in providing direct feedback:** Smart meters can sometimes become inefficient when users are required to get direct feedback about their electricity consumption. User needs to be onsite (at home in case of a domestic user) to get information provided on the smart meter's screen. This makes it inefficient in cases where direct feedback is required.

1.7 Problem statement

Provided with the challenges faced in smart grid technologies [23, 24, 25] there are concerns whether smart grid will bring some significant changes. The cost required to deploy advance metering (which is the most important enabling technology in a smart grid environment) is also relatively high. This makes it very challenging for developing and low budget economies to go for the deployment of smart grids.

Sarah Darby [26], and Dobbyn and Thomas [27] have mentioned that a large number of domestic electricity consumers are not aware of their electricity consumption. They also don't know about the cost associated with their consumption during peak-times. This invisibility of information is one of the main reasons for most of the electricity wastage today by domestic consumers. The electricity utilities cannot offer demand-side or demand response based policies because of lack of real-time consumption information of their consumers. This brings the need to have a cost

effective way for low budget economies to monitor the electricity consumption of their consumers and enable them to do demand-side management during the peak electricity needs. To achieve maximum results the system must provide feedback about electricity consumption in as direct a way as possible [28].

1.8 Goals, Constraints, and Scope of the project

- Propose an idea for developing economies to provide their consumers with direct feedback in as real-time as possible.
- Develop and test a prototype proof of concept to verify the hypothesis.
- Discuss the results.
- Conclude with some future recommendations.

1.9 Guide to the report

Chapter 2: Chapter 2 describes the concept of “Demand response” and “Demand-side energy management”. All commonly used demand response strategies are also discussed. At the end of Chapter 2 it is established that there are needs to have demand response programs that are primarily driven by the domestic electrical energy consumers

Chapter 3: Chapter 3 covers the details about the research question and describes the methodology used for answering the question. Under section 3.3 a proposed solution has been presented and discussed.

Chapter 4: Chapter 4 is about the implementation of the proposed system (system that is proposed in chapter 3). The main content of this chapter is about the proposed system’s design and its implementation. Chapter 4 also provides the details about how the experimentation was conducted for proof of concept purposes.

Chapter 5: The proof of concept of the system (system presented in Chapter 4) worked according to the expectations and helped to obtain some results that are discussed in this chapter. Chapter 5 also analyses these results and concludes with some recommendations for the electricity utilities.

2 Demand Response and Demand-Side Energy Management

2.1 Introduction

Chapter 1 discusses the existing power grid infrastructure and challenges associated with the existing power markets, especially in the South African power sector. “Smart grid” is presented as the permanent solution of the problems in the existing grid infrastructure however, smart grid is not the solution for low budget economies for several reasons explained in chapter 1. Chapter 1 also describes the benefits of feedback on electricity consumption. “Smart meters” were used as a medium to provide feedback on electricity consumption. Smart meters also come with their pros and cons. Chapter 1 concludes with a problem statement that electricity utilities face today in low budget economies.

Chapter 2 covers the concept of “Demand response” and “Demand-side energy management”. In chapter 2 all commonly used demand response strategies are discussed. At the end of this chapter it is established that there are needs to have demand response programs that are driven by the domestic electrical energy consumers.

2.2 Demand-side Energy Management

Electricity systems design and operations are more complex than many other systems because of the following characteristics:

- Electricity demand is unpredictable at any given time
- It is also not yet possible to store electricity on a larger scale,
- This makes it compulsory to keep a balance between system demand and generation at any given time to ensure its reliable operations
- It also requires both system-wide and local requirements including synchronization of the generators generating electricity, and balancing the demand curve to the generation capacity
- Another unique characteristic of electricity is the way it flows over the network. While electrical energy flows from source to sink, it finds its own paths according to physical laws over a transmission network.

In practice, over the last one hundred years electricity operations have been complex and electricity systems are difficult to design. Electricity is an essential part of our modern day life, and the cost associated with it is not a significant part of a consumer’s total expense. Because of the low cost, convenience, and easy usability of electricity in our daily life the demand is increasing. Hence, it is difficult to keep a balance between demand and generation curves. These imbalances can cause a system-wide instability resulting in system-wide blackouts within a short amount of time (sometimes within a few seconds) [32]. Such imbalances caused a major energy crisis in California during the year 2002 which had some severe economic losses [33]. This

motivates a need to consider applying demand-side management strategies in electricity markets for reliable system operations.

The Electric Power Research Institute (EPRI) first introduced the term demand-side management (DSM) in the 1980s [34]. Governments and electricity utilities designed policies to encourage (or sometimes enforce) electricity consumers to change their normal pattern of electricity consumption. This is normally to shift their load during the peak-hours of electricity demand to off-peak hours. Such changes in consumption patterns helped achieving social welfare benefits. Electricity utilities can also run their systems more reliably and smoothly if their consumers are able to shift their load to off-peak times of electricity demand. Demand-side management is a combination of different sub-systems working together to achieve and enhance the efficiency and reliability of the whole electrical system. These three sub-systems are defined as follows:

- **Energy Efficiency (EE):** energy efficiency can be achieved by installing permanent energy efficient technologies or by reducing the energy losses from an existing system. The idea is to use comparable services, but reduce overall electrical energy consumption. Energy efficiency can be achieved by:
 - Replacing incandescent light bulbs with compact fluorescent bulbs.
 - Using home automation devices.
 - Use energy rated appliances.
 - Installing energy efficient chillers etc.
- **Energy Conservation (EC):** energy conservation means using less of an available energy resource. This can be achieved by making a behavioral change in an electrical energy consumer's lifestyle for a short period of time or make it a permanent habit. Examples of energy conservation are:
 - Lowering thermostat to 15⁰ C from 18⁰ C for a heating system.
 - Use full load in a washing machine.
 - Wear light clothes in summer.
- **Demand Response (DR):** demand response is related to changing the pattern of electricity consumption based on time. It is a load management or load shifting technique that helps the electricity grid operator keep the system in a stable form during the peak-time of electrical energy demand. Demand response doesn't necessarily reduce the overall consumption of electricity but it curtails load in response to a signal from the grid operator during the peak demand times. An example of demand response is:
 - Dynamic pricing is a new metered load management approach that uses price signals to induce consumers to reduce energy use at specific times of the day, typically when energy is the most expensive to procure.

In a well-designed demand-side management program each of these sub-systems performs their respective tasks. Experience shows that demand-side management programs are more effective when all three sub-systems are properly implemented and coordinated. The functions of each sub-system support the functions of the other sub-systems. However, some inconsistent results

might appear in a badly designed demand-side management program. This makes it compulsory to take care when designing a demand-side energy management program [31, 34].

Energy efficiency, energy conservation, and demand responsive actions, such as electrical energy consumption management, and shifting load (often shifting load from peak-time to off peak-time) are some of the electrical energy demand reducing methods available. All these methods are defined by the term demand-side management (DSM). Demand-side management programs are often designed to achieve the following benefits:

- Reduce overall energy consumption by replacing energy hungry appliances with energy conservative, energy friendly or green appliances.
- Reducing amount of load during the peak consumption times by shifting it to off-peak times.

2.2.1 Types of demand response programs and their effectiveness

Demand response (DR) is a possible means by which electricity utilities can use DSM as a tool to achieve system reliability. DR is a set of different activities working together to change the amount or time of electricity usage. This results in achieving better social welfare or sometimes for maximizing the benefits of electricity utilities or consumers. A study by ICF estimated the prospective benefits of active demand response at \$7.5 billion by 2010 (ICF 2002). Other studies, described in GAO (2004) [34], give further details of the benefits that have already been generated because of demand response and active retail choice. Federal Energy Regulatory Commission (FERC) also reported the results of demand response investigations and implementations in the US utilities and power markets [35]. The FERC analysis report states that consumers were responsive when they were asked to adjust their consumption. This adjustment was driven by the costs and benefits they get. Consumers reacted on these signals by taking one of the following actions:

- a) adjusting routine business activity specifically to avoid paying higher than average prices;
- b) forgoing discretionary usage; and
- c) deploying distributed or on-site generation.

The FERC Report is evidence of electricity consumers reacting when provided with the price signals about their electricity consumption. Experiences in New York, Georgia, California, and other states and pricing experiments have confirmed that consumers are responsive to price, and they also take actions to reduce their electricity consumption during peak-times. The report [35] has categorized demand response programs into two main groups and several subgroups.

2.2.1.1 Incentive-based demand response programs

The first group of demand response programs is referred to as “incentive-based demand response”. Incentive-based demand response programs do not provide real-time pricing information; hence, they do not require consumers to respond immediately. This also means that consumers do not play a role in managing their electricity consumption. Such demand response programs require more active tools for load-serving entities and electricity utilities (in some cases the grid operators) to manage their costs and maintain their system reliability. The FERC Report has found six types of programs that are based on incentive-based demand response principles.

2.2.1.1.1 Direct Load Control (DLC)

Direct load control (DLC) programs are programs designed where the electricity utility or grid operator can control the consumer’s load remotely for the overall system reliability. This normally occurs during the peak-time of electricity demand. The electricity utility or the grid operator rebates or gives incentives to the consumers for deploying a direct load control program.

Direct load control programs have been practiced at least over the past two decades. Several electricity utilities have used these programs in the late 1960s, and expanded those programs extensively during the 1980s and 1990s. In the US by 1985, there were 175 domestic (residential) consumer direct load control projects and 99 commercial projects were deployed by electricity utilities. The FERC survey [35] also reports that Florida Power & Light has implemented the largest direct load control program, with 740,570 consumers among all 234 reported electricity utilities.

The most common form of direct load control programs control the operations of air conditioners and water heaters. A one-way remote switch (also known as a digital control receiver) connected to air conditioners or water heaters can be controlled remotely. Remotely switching off the appliance helps reduce the overall electricity consumption on the network. These reductions vary by size of the connected appliance, consumer’s usage pattern, and the climate but, a general estimate is that, reductions for each air conditioner is about 1 kW and for water heaters about 0.6 kW.

2.2.1.1.2 Interruptible/curtailable rates (I/C Rates)

Interruptible/curtailable rates demand response programs are generally offered to utilities’ largest consumers. Typical minimum consumer sizes to be eligible for interruptible/curtailable tariffs range from 200 kW for the base interruptible program in California to 3 MW in American Electric Power’s (AEP) Ohio service territory. Consumers on these rates agree to either curtail a specific block of electric load or curtail their consumption to a pre-specified level. Consumers committed to these rates typically must curtail within 30 to 60 minutes of being notified by the utility. Electricity consumers using interruptible/curtailable service rates/tariffs are given with

discounts or bill credit exchange for participating in reducing their load during the peak electricity demand time [35, 36]. If these consumers fail to reduce their load during system contingencies, they can be penalized. Interruptible/curtailable rates are not suitable for all consumers especially for those who have a 24 hour-a-day, and seven days-a-week continuous operations [35].

The FERC survey report [35] lists some 218 electricity utilities in the US offering interruptible/curtailable rates demand response programs. The main target for most of these programs is large industrial and commercial electricity consumers. About 95 cooperatives and political subdivisions have consumers registered on interruptible/curtailable rates based demand response programs.

An analysis of the load impacts of the Interruptible/curtailable rates demand response programs has been done by [36]. Their results are based on a two years study of Interruptible/curtailable rates demand response studies, sponsored by the Electrical Research Power Research Institute. The study is based upon data from 150 customers at ten electricity utilities offering Interruptible/curtailable rates services. The regression methodology was applied to 147 industrial and commercial customers at ten-electricity utilities using data from a single summer season (May to September). They have reported that a significant load reduction can be achieved, with actual experience ranging from 1 to 125 MW at different electricity utilities [36].

2.2.1.1.3 Demand bidding/buyback programs

Demand bidding/buyback is one of the newest incentive-based demand response programs. Demand bidding/buyback programs encourage large-scale electricity consumers to reduce their electrical energy consumption at a rate at which they are willing. The other alternative to this is that large-scale electricity consumers commit on an amount of load they can curtail at a posted price by their electricity utility. The electricity utility will curtail load if electricity consumer's bids are cheaper than secondary (alternative) supply options or bids. Demand bidding/buyback demand response programs are popular among consumers because, they get benefit of flat/fixed rates for their electricity consumption, but receive higher payments for their load curtailment when electricity generation costs are higher.

Demand bidding/buyback demand response programs are normally deployed into two different forms [35]:

- a) The first of its kind incorporates demand bids directly into the system optimization and electricity consumption scheduling process. New York Independent System Operator (NYISO)'s Day-Ahead demand response program (DADRP) is a typical example of such types. In NYISO's DADRP consumers bid a price at which they want to curtail their load and the amount of load in MW on a day-ahead basis. If these bids are selected for

deployment, the electricity utility will inform the consumers to curtail their load if there is a system reliability threat because of excessive electricity demand. The electricity consumers will then execute load curtailment the next day. If the consumer fails to curtail the amount of load that they committed to, the electricity utility penalizes them.

- b) In the second form of demand bidding the consumer is a price-taker. Real-Time Price Response Program at ISO-NE is an example of such programs. The consumers are paid the current market-clearing price for their load curtailments.

2.2.1.1.4 Emergency demand response programs (EDRP)

Emergency demand response programs have been in use since the last decade. Emergency demand response programs provide incentives to their consumers who participate in reducing their electricity consumption during reliability-triggered (normally during peak-time of electricity demand) events. Emergency demand response programs are different from Interruptible/curtailable rates demand response programs because, curtailment of load in emergency demand response programs is voluntary. Consumers have a choice to decide if they want to curtail their load during the peak-time of electricity demand or not. Consumers are also not penalized in case they do not curtail their load. This voluntary nature of emergency demand response comes with its own challenges, for its use in grid operations and planning because, it is difficult for the grid operators to estimate the amount of load reduction when the program is activated [35, 37].

According to the FERC survey report [35] there are 27 electricity service-providing utilities, which have deployed emergency demand response programs in the US. Emergency demand response programs were particularly popular in some parts of the US, where many utilities, retailers, and curtailment-service providers participate in ISO/RTO emergency programs.

The New York Independent System Operator (NYISO) estimated that its demand response program helped achieving substantial benefits to the market by contributing in power grids recovery from the August 2003 Blackouts. NYISO estimated that on August 15, 2003, their participating demand response program of 593.9 MW earned them \$50.8 M (US) worth of economic benefits [37].

2.2.1.1.5 Capacity market programs

Capacity market programs work like a form of insurance that means after a few years the participant will get a guaranteed premium without paying anything. The consumers enrolled for capacity market demand response programs commit to curtail their pre-specified load in case of a system reliability threat. The utility will penalize the consumer in case of a failure in load curtailment. The participants of capacity market program get a guaranteed payment for being obliged to curtail their electricity consumption during the system contingencies.

The consumers who want to enrol themselves for capacity market programs not only need to be obliged to curtail load, but they also need to demonstrate that they can reduce their consumption by the level of their commitment. For example, the requirements to receive capacity payments in NYISO's Special Case Resources program are: minimum load reductions of 100 kW, minimum four-hour reduction, two-hour notification, and to be subject to one test or audit per capability period. This is just to ensure that the consumers can reduce their consumptions in case of an emergency.

2.2.1.1.6 Ancillary-service market programs

Consumers who commit to be a part of ancillary services market based demand response programs act as an operating reserves for the ISO/RTO markets. If consumer's bids are accepted, they are paid the market price for committing to be on standby. ISO/RTO calls the consumer in case of a load curtailment need. To participate in ancillary services the consumers have to enable themselves to react quickly on a load curtailment request. Typically, this response time is in minutes rather than the hours required when peak shaving or responding to price signals. To react in quick time for the load curtailment the consumers need to install advanced real-time telemetry equipment. Consumers normally with large industrial processes are the ideal targets to deploy ancillary services market based demand response programs. Consumer's advanced real-time telemetry equipment can help to switch off their big load such as, electric arc, steel furnaces, large pumping load, or air conditioners.

2.2.1.2 Time-based rate/dynamic pricing programs

In the past electricity utilities have offered a flat rate to their small, or low-volume, commercial, or residential electricity consumers. A noted electricity utilities rate expert, James Bobright, first presented the theory of defining flat rates. Bobright says that rates should be fair, simple, acceptable, effective, equitable, non-discriminatory, and efficient. Electricity utilities or other LSEs owns the electricity generating facilities (such as power generation plants), or they buy electricity from a generation company in bulk quantities on a long term contract. Electricity prices are dependent on location of consumption and/or time of its consumption. This variation in the price enforces the electricity utilities to incorporate a risk premium factor price in their electricity tariff.

US Department of Energy's (DOE) EAct Report published in February 2006 [42] discussed that flat electricity prices based on average costs can lead electricity consumers to "*over-consume – relative to an optimally efficient system in hours when electricity prices are higher than the average rates, and under-consume in hours when the cost of producing electricity is lower than average rates.*" This is the reason that many economists and electricity services policy-makers have been insisting and promoting the use of dynamic pricing (time-based rates).

2.2.1.2.1 Time-of-use (TOU) pricing

Time-of-use rates are the most widespread time dependent rates deployed especially for domestic electricity consumers. Electricity consumers are exposed to some form of time-of-use rates (in some cases rates that vary by six months season). Such six-month rate variation is called seasonal rates. In more advanced time-of-use rates the electricity utilities define two sets of time frames called peak-times or off peak-times. When the electricity generation system is at its peak load the electricity utilities will refer to it as peak demand time and charge higher rates for electricity consumption than the off-peak demand times. The definition and time span for time-of-use rates vary for different electricity utilities based on the timing of their peak system demands during the day, week, or year.

2.2.1.2.2 Critical peak pricing (CPP)

Critical Peak Pricing (CPP) based programs impose very high critical peak prices. These kinds of programs are different from traditional TOU programs. A specified high unit rate for usage is charged throughout the time of critical peak pricing duration. These timings are usually because of the system contingencies, or high prices paid by the electricity utility in procuring power from the electricity generation companies or from the wholesale markets. The time blocks (or the days, and/or seasons) during which the critical peaks can occur are not predefined like they are in TOU based programs. Critical peak pricing is a price-based strategy but the fact that electricity utilities can call it in real-time at periods of high system demands makes it equally reliability-based demand response strategy. Critical peak pricing rates can be used in following variants including:

- **Fixed-period CPP (CPP-F):** Fixed-period critical peak pricing is a form of CPP strategy in which the time and duration for which the price will be charged as increased price is predetermined. Maximum numbers of days for which the critical pricing will be used are also usually predetermined but the actual days cannot be mentioned. These events are typically announced on a day-ahead basis.
- **Variable-period CPP (CPP-V):** In variable-period critical peak pricing the time of the event, the duration for which it lasts, and the days of the price increase are not predefined. These events are usually called on a day-of basis. The CPP-V based programs are typically paired with the consumer appliances such as communicating with thermostats that allow automatic switching ON/OFF in case of a critical peak-pricing event.
- **Variable peak pricing (VPP):** In variable peak pricing, “the peak price for each peak-period hour would be set each day based on the average of the corresponding ISO Day-Ahead Connecticut Load Zone locational marginal prices (LMPs), adjusted to account for delivery losses and other costs typically recovered volumetrically [35]”

- **Critical peak rebates:** Electricity consumers remain on fixed rates but will be given a rebate for their load curtailment/reduction during the event of critical peaks.

2.2.1.2.3 Real-time pricing (RTP)

Real-time pricing (RTP) are the rates that vary continuously during the day. This dynamic change in rates reflects the change of electricity generation cost in real-time. This kind of scheme also helps to keep price synchronization between wholesale, and retail electricity markets. This direct connection between these two markets brings price responsiveness in the retail markets. Real-time pricing are used in the following variants:

2.2.1.2.3.1 Day-ahead real-time pricing (DA-RTP)

Electricity consumers on Day-ahead real-time pricing programs are provided with one-day notice of the prices for each of the next 24 hours. This information enables them to plan their activities for the next day. These activates can be shifting their load from peak-time to off-peak times, switching their onsite generation facilities, or day-ahead prices with other products only if they cannot curtail their loads.

2.2.1.2.3.2 Two-part real-time pricing (TP-RTP)

Day-ahead real-time pricing is an alternative to two-part real-time pricing strategy. This is also the most commonly used real-time pricing demand response program in the US electricity markets. Two-part real-time pricing demand response programs use a historical baseline of their electricity consumer's consumption. This historical baseline is layered with hourly prices only for marginal usage above or below. These baseline rates work as a hedge for the electricity consumers and can help them to achieve savings by shifting their marginal loads from peak-time of electricity demands to off-peak times.

2.3 Challenges with the existing demand response strategies

Table 2 lists the types of most used demand response strategies at present. It is clear from the data that only five out of ten demand response strategies are aimed at domestic consumers. Sarah Darby [26] in her literature survey on metering, billing, and direct displays mentions that domestic energy consumption information is still invisible to millions of the domestic consumers. This is the one of the prime reasons for the waste of much electrical energy. Problem with existing domestic consumer based demand response programs is the means through which the consumption information is provided to the consumers. The smart meter was used as a tool to provide the consumption information in real-time but the smart meter has its own merit and demerits. The consumer needs to be on site (*at their house in case of a domestic consumer*) to get benefit out of the information provided on the smart meter. Another challenge with these demand response programs aimed at domestic consumers is that they are electricity utility-based programs. The electricity utilities have full control over an enrolled consumer's (*consumers who*

has enrolled themselves for the demand response program) appliance (such as in Direct Load Control type programs [34, 35]). The utility decides when to switch the consumer's appliance ON or OFF. This situation can lead to consumer dissatisfaction.

Table 3: Existing demand response strategies

Type of Demand Response Strategy	Aimed At	No of Utilities Reported in the US
<i>Incentive-Based Demand Response Programs</i>		
Direct-Load Control	Domestic & Commercial Consumers	234
Interruptible/curtailable rates	Commercial Consumers	218
Demand bidding/buyback programs	Commercial Consumers	18
Emergency demand response programs	Domestic & Commercial Consumers	27
Capacity market programs	Commercial Consumers	16
Ancillary-service market programs	Commercial Consumers	1
<i>Time-based rate/dynamic pricing programs</i>		
Time-of-use (TOU) pricing	Domestic & a Small Roll out for Commercial Consumers	187
Critical peak pricing (CPP)	Domestic & Commercial Consumers	25
<i>Real-time pricing (RTP)</i>		47
Day-ahead real-time pricing (DA-RTP)	Industrial, Commercial, Institutional, and a small	
Two-part real-time pricing (TP-RTP)	Commercial and Industrial retail consumers	

2.4 Need for consumer based demand response programs

Most of the demand response programs listed in Table 3 are electricity utility driven programs. The consumer has no or very little involvement when participated in one of these programs. This lack of decision making choice can lead to consumer dissatisfaction resulting in failure of the

demand response program and over all electrical system instability. Such challenges bring the need to have a demand response strategy which is predominantly consumer based. Sarah Darby's [26] research on metering, billing, and direct displays explains that domestic consumers are found responsive when they were provided with the information about their electrical consumption. The report suggests that domestic consumers are found to reduce their electrical consumption ranges 5 to 10%. This amount of reduction is very encouraging for both the electricity utilities and the grid operators. These reductions can help grid operators to keep their system stable during its operations. To achieve these benefits the electricity consumer should be provided with the choice and tools to decide about his/her electricity consumption. Time-based rate/dynamic pricing programs can be a good choice for the consumer based demand response programs, but they come with their own challenges such as:

- Domestic electricity consumers need to be alerted in-time (as soon as possible after the consumption behavior) to react on the provided feedback.
- It is noticed in [28] that this feedback is more effective when provided as:
 - The amount of electricity they are consuming at any given time, and
 - The cost associated with their current electricity consumption.
- Utilities must provide tools or means to provide this consumption information to the consumer irrespective to their geographical location.
- Consumers must also be provided with suitable tools to curtail their load or even to change their consumption pattern.

2.4.1 Challenges in deploying consumer based demand response programs

It is discussed and proposed in Section 2.3 that there is a need for consumer based demand response programs. Consumer based demand response programs can be more consumer friendly however, it is challenging to offer such programs. A few of these challenges are discussed here:

- **Cost associated with installing consumption monitoring equipment:** to offer consumer based demand response programs it is required to monitor domestic consumer's electricity consumption in real-time. From the Malta Smart Grid project experience it is estimated that the cost of installing advanced meters and some of the other required equipment and infrastructure has been about \$360 per consumer (derived from data provided in [24]). Study in [22] also supports the argument that it requires billions of dollars to install smart meter based systems in distribution networks. It also requires substantial amount to maintain these systems.
- **Advancement in technology:** A sophisticated software system is required to run a smart meter based system effectively. The technologies that are currently being deployed will be very different from those that will be available in ten years time. But the meters will be going out today have no way of being upgraded in a cost efficient manner. This

advancement in technology has its own challenge in deciding to chose an appropriate smart meter to measure domestic consumer's electricity consumption in real time.

- **Communication infrastructure:** In the existing electricity grid infrastructure there is no means of communication between the home monitoring system and electricity utility. The service providing utilities need an effective and reliable communication means to get the electricity consumption information back to them in real time. This requires building up a massive communication infrastructure where there was none before.
- **Timely information delivery:** In order to get full benefit of providing consumption feedback to domestic electricity consumer and enable them to do demand side energy management it is required that they are provided information on time. This feedback information is found more effective when provided frequently and, as soon after the consumption behaviour as possible [28]. To achieve this it requires having efficient and reliable technologies deployed in the grid infrastructure.

2.5 Similar work

Work done by researchers at Tasmania ICT centre, Australia [40] proposed a microcontroller based system with remote control interface for the purpose of Home Automation and demand-side automatic meter reading (AMR). The bi-directional and asynchronous Power Line Communication (PLC) links among the different components of the system. Their proposed system also has a user-friendly remote interface through the GSM infrastructure. This kind of a domestic system to perform an intelligent control over electricity consumption for a domestic consumer can help them to reduce their electricity consumption. However, they did not test the applicability and effectiveness of the system in real world environment. Furthermore, they had no means in the system to alert a domestic consumer during the high demand times of electrical energy.

3 Research Question, Proposed Solution, and Methodology

3.1 Introduction

Up until this point the background about current challenges in the electricity market has been discussed. It has also been identified that smart grid is the way to proceed in future in order to achieve reliable electrical system operations including, generation, transmission, distribution, and efficient electricity consumption. Adopting smart grid technologies for low budget economies has some challenges that have been discussed in section 1.4.2. Benefits of feedback in domestic consumer's electricity consumption information are presented in section 1.5. The concept of demand-side management is explained in chapter 2. Use of demand response programs and their types for deploying demand-side management programs in electricity market has also been discussed in detail in chapter 2. Referring back to the question raised in section 1.7 about *a need to have a cost effective way for low budget economies to monitor the electricity consumption of their consumers and enable them to do demand-side management during peak electricity demand*, and provided with all the background information it has been established in section 2.3 that there is a need to design consumer based demand response programs (especially for domestic consumers). Challenges associated to deploy such programs are listed in section 2.3.1. The remaining part of this report proposes a system that can enable electricity utilities to offer consumer based demand-response programs. The proof of concept of the proposed system answers the questions as to *whether consumers provided with feedback information on their electricity consumption via their cell phones will react? And can this help in shifting/reducing their electricity consumption during the peak system demand times?*

3.2 Cell phone: an enabling technology or tool to provide direct feedback

Cellular technology and cell phones have made changes in our modern day life style. According to the International Telecommunication Union (ITU) [39] there are around 5.98 billion cell phone connections that have been deployed in the World by the year 2011. In Africa alone there are approximately 433 million cell phones in use [39]. The modern cell phone networks are reliable enough to reach their subscriber even in rural areas. This advancement in cellular technology can enable electricity utilities to provide their consumers (especially domestic consumers) with information about their electricity consumption anywhere anytime. This feedback about a consumer's electricity consumption provided via cell phone can encourage the consumer to reduce their overall electricity consumption or even, to shift their loads from peak demand times to off-peak demand times. This shift can help electricity utilities and electricity grid operators run their operations smoothly and reliably. The feedback about electricity consumption provided on a cell phone can also overcome the disadvantage with the use of a smart meter because electricity utilities can provide this information to their consumers irrespective to their geographical location. Once the users are provided with their electricity consumption information they can then do demand-side management (i.e: they can turn their appliance ON and OFF via their cell phone [40]).

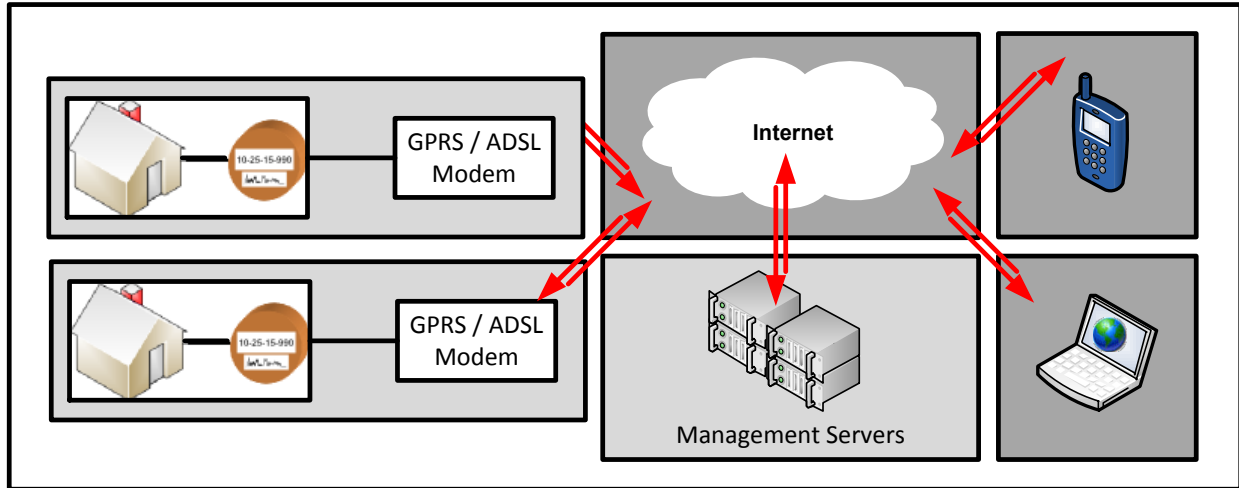

Figure 2: Abstract system diagram [41]

3.3 Proposed solution

This section discusses the operational details or the abstract overview of the proposed system. The proposed system can enable electricity utilities to offer consumer driven (consumer based) demand response programs. To achieve consumer driven (consumer based) demand – response program the concept of smart sockets is proposed. An abstract system diagram of the smart socket based system is shown in Figure 2. In the proposed system each electrical appliance’s electricity consumption in a domestic consumer’s house will be measured in real time using smart sockets. These electricity measurement values can be sent back to a server over Internet infrastructure through GSM mobile operator’s network (using a GPRS/3G modem) or using an ADSL Internet infrastructure. The server somewhere in the Internet cloud must store all this electricity consumption information. The server must also monitor the inbound consumption information in real-time and should alert the domestic consumer in case of an abnormality in their electricity consumption pattern. It must also send alerts to the consumer (alerts are in the form of an SMS) if the consumer-selected appliances are switched ON during the peak electrical energy demand times. The proposed system presents the concept of a web interface for the consumer that can be viewed on a GPRS enabled cell phone or any Internet enabled browser. This web interface enables domestic consumers to view their electrical energy consumption information and do demand side energy management (i.e. to switch an appliance ON or OFF remotely). This kind of a system that can alert consumers in case of an event of high electricity demand or during peak electricity demands, and enable them to do demand – side energy management remotely can be more effective. Electricity utilities can use the concept of smart sockets to offer consumer driven (consumer based) demand – response programs. Consumers can also be more satisfied by gaining more control on their electricity usage pattern.

3.4 Research methodology

The research is carried out using a mixture of two different types of research methodologies to answer the question asked in Section 3. It is the combination of *Field Experiments: Doing Research in the World* and *Controlled experiments: changing things systematically and seeing what happens?* Field experiments research is normally conducted on “What-if” based questions. Answering these kinds of questions are exciting but often difficult. Researchers can form a questionnaire to ask people what would they do if something happened, but there is no guarantee that what they tell you will have much relation with the actual fact. A more justified approach would be making a “What-if” scenario and observe how people react to it. If you do it in the outside world, then it is a field experiment [43]. Based on existing knowledge and research results, it can be concluded that electricity consumers would react on the information (information about their electricity consumption) provided them in real-time. However, this needs to be verified in a real world environment. This can be achieved by designing an experiment where electricity consumers are informed about their electricity consumption, and are given a choice to decide if they want to participate in demand-side energy management activities. With such an experiment we can observe and record the consumer’s behaviour to this “What-if” scenario in the real world. To verify the effectiveness of this experiment, there is a need to change things systematically and see what happens. Changing things systematically and observing the change in results is a concept of controlled experiments [43]. This proposed research requires the change in scenarios and observe the difference among different scenarios.

For field experimentation research methodology there is a need to design an experiment and verify it in the real world. The experiment must present domestic electricity consumers a scenario where, they are alerted with the information about their electricity consumption. The user must also be given an option to decide if they want to change the status of their reported appliance (to switch OFF the appliance or switch it ON). This experiment will help to observe the change in behaviour of the electricity consumer in case of provided alerts. This can also provide supplementary information that can be statistically analyzed to find out if the electricity consumers are able to reduce their overall electricity consumption during the peak demand times or not.

4 Proof of Concept and Implementation

4.1 Introduction

For the proof of concept, that domestic electricity consumers would be able to reduce their electricity consumption during the peak times of electricity demand, a prototype system based on the concept of smart socket is designed and tested. During the testing phase this prototype system also helped to answer the question that *whether or not domestic electricity consumers react on the information provided to them about their electricity consumption during high demand of electrical energy?* This chapter presents the details of the system that has been developed for the proof of concept purposes, and also describes the tests run to answer the questions raised in previous sections.

4.2 System design and implementation

The proposed system of smart sockets is built using an open source electronics prototyping platform called Arduino [44], which is a flexible and easy-to-use hardware and software platform. Arduino is an open source physical computing platform based on a simple microcontroller board, and with a development environment for writing software for the board [44]. The proposed system itself is an extension of an open source energy-monitoring project explained in [45]. It adds more functionality than the system developed in [45]. Physical and Logical system diagram developed for the proof of concept are shown in Figure 3. Physically the system is divided in following three main components:

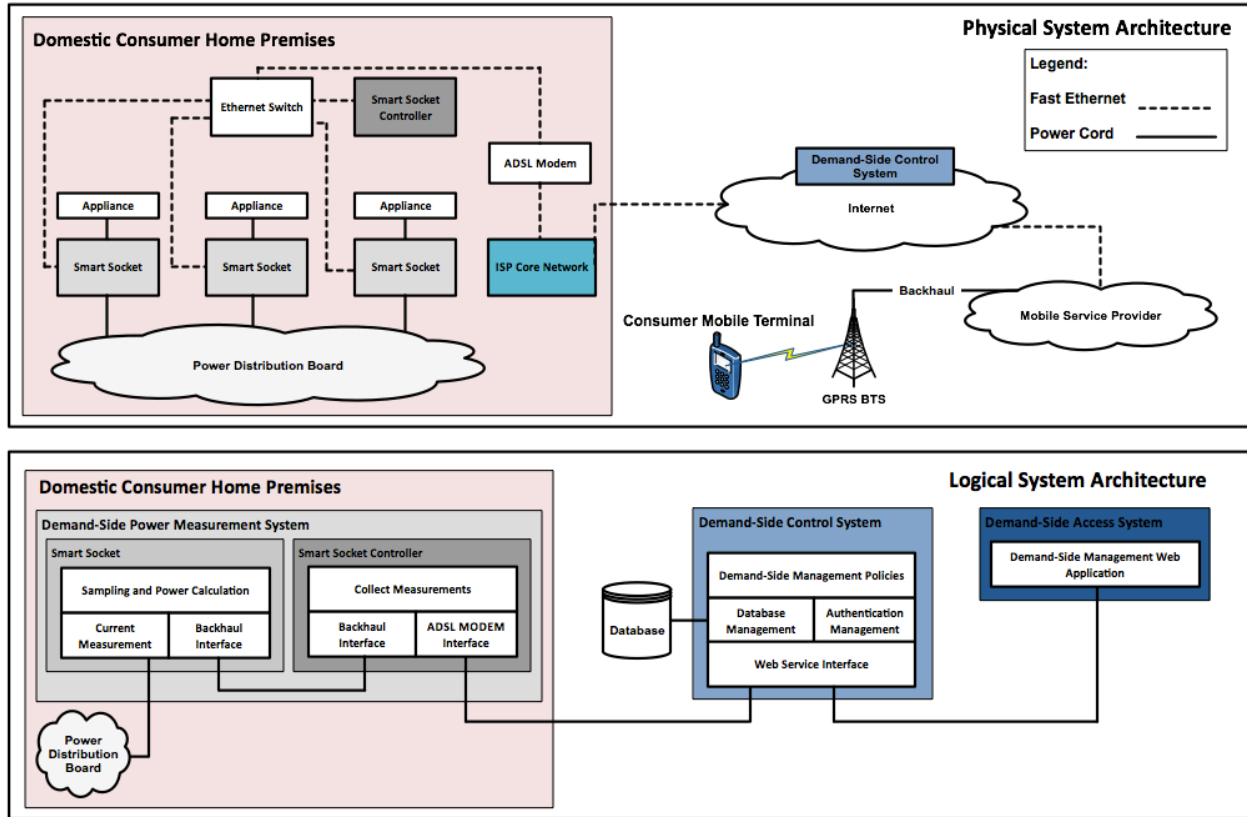

Figure 3: Physical and Logical system diagram

4.2.1 Demand-side power measurement system

Demand-side power measurement system is installed in the domestic consumer's home premises. This is core of the system that monitors the electricity energy consumption in real-time and, sends the consumption information back to the Demand-side control system (explained later in the chapter). Demand-side power measurement system consists of two further components (discussed below). All of these components are connected with a central Ethernet switch in domestic consumer's home premises.

4.2.1.1 Smart socket

Smart socket is the main component of the demand-side power measurement system. It is powered directly from the power distribution board/wall plug. Some selected electrical appliances in a domestic consumer's household connect through the smart socket. The smart socket monitors the electrical energy consumption of the connected appliance in real-time. Smart socket is also capable of switching the appliance ON and OFF remotely by sending the control commands through smart socket controller (discussed later in the chapter). Each smart socket has a current transformer (CT), which monitors the electrical energy consumed by the connected appliance in real-time. This current transformer feeds the information to the Arduino board,

which is part of the smart socket. The Arduino board's Ethernet interface enables each smart socket to connect to the other nodes in the network over a standard Ethernet interface.

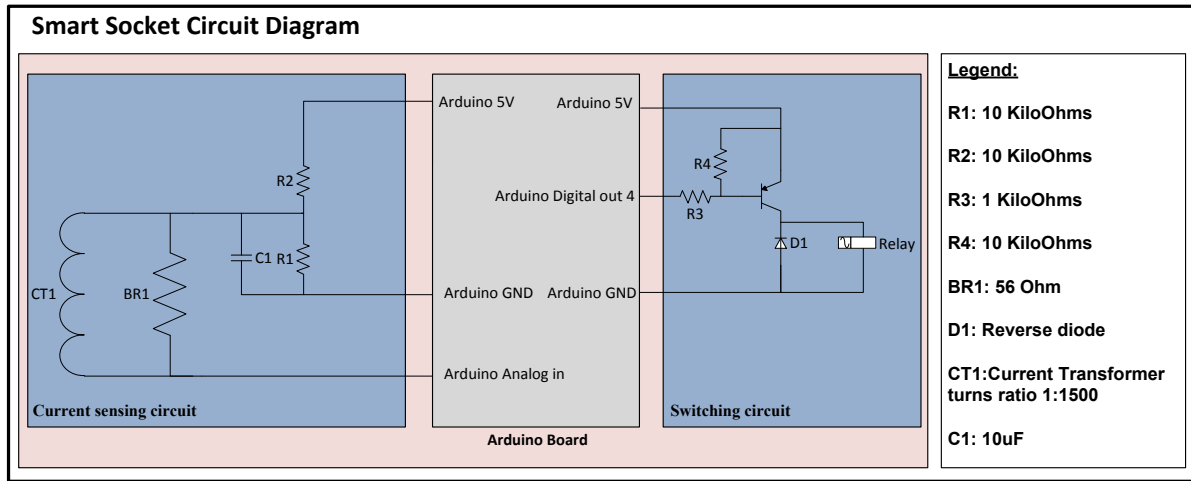

Figure 4: Smart Socket Circuit Diagram

The Arduino board placed in the smart socket runs a piece of software which is responsible of sampling the analog signals received from the connected current transformer. This is shown in Logical System Architecture, Figure 3 as sampling and power calculation. After sampling these analog signals the software program calculates the electrical energy consumed by the connected appliance in real-time. On request from smart socket controller it transmits this measured electrical energy consumption information through the backhaul interface (standard Ethernet interface) to the smart socket controller, which is responsible for collecting measurements from all connected smart sockets. The internal circuit diagram of smart socket is presented in Figure 4.

Circuit shown in Figure 4 is divided in two main parts. The part on the left-hand side of the Arduino board is called current sensing circuit and the part on the right-hand side of Arduino board is called switching circuit.

Current sensing circuit measures the current flowing through the smart socket. The current sensing circuit consists of a sensor (current transformer), which produces analog signals proportional to the current flowing through the mains. This CT (current transformer) works on the induction principal. The current flowing through the mains generates a magnetic field in the ferrite core of the CT. A secondary coil is wrapped around the ferrite core. When a resistor is connected across the terminals of the coil a current flows that is proportional to the current in the mains wire [45]. The CT used for the proof of concept clips around the wire to be measured that makes it easy to use to measure electrical energy used by the appliance connected to the smart socket. The numbers of secondary turns on the CT used in the smart socket are around 1500. This means that the current in the secondary coil is 1500 times less than the current flowing

through the mains wire. The secondary coil is also electrically isolated from the main current. This ensures that CT is a safe way for measuring the mains current. A burden resistor connected in parallel with the CT sensor converts the current from the CT into a voltage value. The two resistors (R1 and R2) from a voltage divider output the voltage at half of the Arduino supply voltage of 5V. This voltage biases the AC voltage produced by the CT sensor and burden resistor by 2.5V, required because the Arduino analog input channel operates only at a positive voltage [45]. The capacitor C1 (10uF) is used to stabilize the DC bias to neglect the source of noise.

The switching circuit on the right hand side of the Arduino board is to switch the power ON or OFF in the smart socket when required. A transistor as a switch is used to switch the connected load ON and OFF. Transistor cannot switch AC or high voltages such as mains electricity. To switch the smart socket ON or OFF a relay is used but note that the transistor is used to switch the relay ON or OFF. If the load such as a motor, relay, or solenoid or any other device with coils is used a diode must be connected across the load to protect the transistor from brief high voltage produced when the load is switched off. The right hand side of Figure 4 shows a protection diode connected backwards across the load.

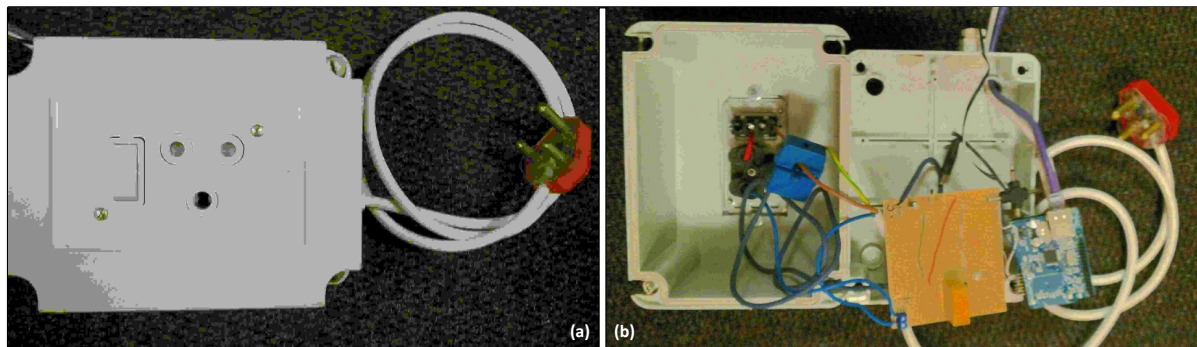

Figure 5: Smart Socket Snapshots

A snapshot of the smart socket designed and used for the proof of concept is shown in Figure 5. The smart socket can be powered from an existing wall plug or distribution board from the domestic consumers household. The appliance to be monitored goes in the smart socket as shown in Figure 5(a), which is the left side of the Figure 5. Figure 5(b) shows the internal part of the smart socket. It is clearly shown that the CT (in blue color) is clipped around the mains wire.

Source code for the software program running on Arduino board in smart socket is available in Appendix II.

4.2.1.1.1 Smart socket design considerations

Smart socket was designed carefully to achieve the robustness and extendibility in its functionality. It was also considered that developing smart sockets at a larger number is cost effective and easy. This section discusses the different aspects of design.

4.2.1.1.1.1 Backhaul interface

Backhaul interface connects smart socket to the other smart sockets inside a house. For the proof of concept purpose a simple Ethernet interface is used to achieve the connectivity of smart socket with the network. This Ethernet is a cabled connection that has its own pros and cons. For wireless connectivity a ZigBee, or WiFi connection can also be used with the Arduino setup. For the large number of development power line communication can also be used to make communication network between different smart sockets over the network.

4.2.1.1.1.2 Current measuring unit

Current transformer has been used to sense and measure the flow of electrical energy from the smart socket. For the proof of concept purpose a current transformer that clips on the mains is used. For the larger number of development a simple current transformer can also be used to achieve the same purpose.

4.2.1.1.2 Smart socket advantages

4.2.1.1.2.1 Easy to install

Proposed system of smart sockets is easy to install. As explained in section 4.1.1.1 the smart socket is powered directly from the wall socket. The appliance that needs to be measured goes into the smart socket. This setup is very easy and safe from the consumer's perspective.

4.2.1.1.2.2 Cost effective

Smart sockets are cheaper as compared to smart meters. Smart meters are generally not capable of monitoring electrical energy consumption of each appliance in a home area network however; smart sockets can measure electrical energy consumption of every single appliance on the network. The cost of smart socket developed for the proof of concept purpose is R. 300 (Three hundreds South Africa Rand). Using the low cost microcontrollers (such as PIC) the cost can be brought down. This is low in cost comparing to smart meters available in the market.

4.2.1.1.2.3 Flexible

The smart socket is designed in as open a way as possible. For the proof of concept purposes the Ethernet interface (wired Ethernet) has been used. However the design allows using wireless boards (built for Arduino). With some small changes in design it is also possible to use power

line communications in a smart socket. This can enable a domestic electrical energy consumer to use their existing power network for communication purposes between different smart sockets.

4.2.1.1.2.4 Extendable in functionality

Currently the software running on smart socket is capable of monitoring and posting electrical energy consumption information in real-time. It also enables smart socket to switching the connected appliance ON or OFF on request. Further functionality such as logging this information locally on a smart socket can also be built. Using the software enhancement it is also possible to make smart socket more intelligent and proactive in cases of emergency.

4.2.1.2 Smart socket controller

The smart socket controller is the main controller for all the smart sockets on the network in a domestic consumer's household. For the proof of concept purposes the software for the smart socket controller is running on a computer. The program running performs the collect and measurement function as shown in Figure 3. The smart socket controller collects the electrical energy consumption information from all the smart sockets on the network and sends it to the demand-side control system (explained later). After sending all the electrical energy consumption information to the demand-side control system it requests the demand-side control system to return with the status to set the appliance (either to change its current status or otherwise). After receiving the latest status information it switches the appliance ON or OFF accordingly. Smart socket controller is the node in the network that issues the commands to each smart socket to alter its status between ON and OFF.

4.2.1.3 ADSL modem

The ADSL modem shown in Figure 3 provides a gateway for the smart socket controller to send the electrical consumption information to the demand-side control system in the cloud. The demand-side control system is a server machine running in the Internet cloud and is accessed by the smart socket controller using the Internet through this ADSL router.

4.2.2 Demand-side control system

Demand-side control system runs on a server machine in the Internet cloud. It is the central repository where all the electrical consumption information from domestic consumer's house is stored. Demand-side control system in concept is divided into five main components as shown in Logical System Architecture part of Figure 3. However, for the proof of concept purpose only three of those systems are implemented. The remaining two parts of the demand-side control system are proposed as the future work. All the components of demand-side control system are explained in this section:

4.2.2.1 Web service interface

Web service interface is a .Net XML web service running on the server machine and performs two main functions.

- The smart socket controller communicates with the web service using HTTP protocol. It can request the system to get the updated status that needs to be set on the actual appliance from the database.
- The smart socket controller sends the electrical consumption information data to the demand-side control system via this web service interface using HTTP protocol. If web service interface receives the data from smart socket controller, it validates the received data and stores it into the database.

The source code of the web service interface is included in Appendix III.

4.2.2.2 Database management

Database management component manages all the requests queried from the physical database. For the proof of concept PostgreSQL as a database management system has been used. PostgreSQL is a powerful, open source object-relational database system with a proven reputation for reliability, data integrity, and correctness.

4.2.2.3 Database

Database serves as the core data repository for data storage. All the electrical energy consumption information coming from the domestic consumer's household is kept in the database. For the proof of concept this database is kept very simple. The database table and the data collected during the experimentation is included in Appendix I.

4.2.2.4 Authentication management

Authentication management component in the demand-side control system validates and authenticates each request to access the information from the database. These requests include query the data about electrical energy consumption information, or issuing commands to switch the domestic consumer's household appliance ON or OFF. The authentication includes checking the validity of the user (whether or not the requesting user is registered on the system), the constraints applied on every user to view the data related to him/her, and also verifies if the user is allowed to issue commands to turn the appliance ON or OFF. This function is not implemented in the system and recommended for the future work.

4.2.2.5 Demand-side management policies

Demand-side management polices component can enable electricity utilities to enforce demand-side management policies. It alerts the domestic consumers in case of an emergency during the peak load times, or in case of an excessive use of electrical energy. The alerts sent to the consumers are via the SMS technology. The consumer receives an SMS on their cell phone in case of an emergency in the system, or in case of any preset event. This can enable and encourage the domestic consumer to logon to the system via their cell phone or any Internet enabled device to see their electricity consumption. From that information the consumer can issue commands to turn their appliance ON or OFF as per their own requirements. Demand-side management policies component can also be used to automate the operation of sending commands to the consumer's household appliances, but this is not the scope of this research. This component has not been implemented as explained for the proof of concept purposes. Sending alerts automatically via the SMS(s) technology is not implemented. However, during the testing phases of the system an SMS alert manually from cell phones are sent to the consumers for simulating the principle. Consumers then replied to that SMS alert and requested to issue the command to switch their appliance ON or OFF. Based on the request received from the consumer the commands were issued to alter or retain the current status of that appliance.

4.2.3 Consumer mobile terminal

Demand-side access system logically is the end user application package. It consists of a web application package as indicated in Logical System Architecture, Figure 3. Domestic electricity consumers can open this web application on their handheld device (cell phones) or any other Internet browsing device to view their electrical energy consumption details. They can also use their device to issue commands to switch any appliance ON or OFF. For the proof of concept purposes during the testing phase the domestic consumer was not provided with a web interface. During this testing phase we issued manual commands to the smart socket controller to alter or retain the status of the electricity appliance on consumer's request. Consumer was given his/her electrical energy consumption information via the SMS technology.

4.3 Experimentation

This research is conducted based on the principles of two different research methodologies as explained in the Section 3.3. An experiment set is designed to determine if domestic electricity consumers can reduce or change their electricity usage pattern when they are given the information about their electrical energy consumption. The experiment lasted for three weeks. To verify the effectiveness of the system (basically the principles), there was a need to change things systematically and notice the change in the results. This section discusses the details about the different scenarios created for testing the effectiveness of the system.

4.3.1 First week of experiment

During the first week of experimentation an appliance (refrigerator for our experiment) at a domestic consumer's premises was monitored as it is. The combination of smart socket and smart socket controller monitored the electrical energy consumption of the attached appliance in real-time and posted it to the demand-side control system in the cloud environment. Appendix I (a) contains the data log for this first week of experimentation. It can be clearly seen in the data that smart socket controller posted electrical consumption information of the connected appliance based on five minutes time intervals continuously. This data shows the normal electrical energy consumption behaviour of the domestic consumer for this particular appliance.

4.3.2 Second week of experiment

In the second week of experimentation the same principle as used in first week is employed with one change. The electrical appliance's electricity consumption information is monitored in real-time and is posted back to the demand-side control system on five minutes time intervals. The change that is made during the second week of test is to keep the electrical appliance switched OFF during the peak times of electrical energy demand. For the proof of concept two-peak demand times of electrical energy were assumed in a day (24 hours). The first peak demand time interval assumed was from 07h00 to 10h00 in the morning and the second peak demand time interval was from 16h00 to 20h00 in the evening. It was made sure that the electrical appliance was kept switched OFF during these time intervals. The data log for this week is presented in Appendix I (b). For the real-world usage of the system in these peak demand time intervals of electrical energy can be dynamic and electrical utilities can define such time intervals based on the electrical grid system's current demand.

4.3.3 Third week of experiment

The third week of experimentation is the one in which the domestic consumers were informed (during the peak times of electrical energy demand) about their electrical energy consumption information via an SMS alert on their cell phones. The electrical energy consumer was then asked if (s)he wanted to keep his/her appliance ON or OFF during mentioned peak time of electrical energy demand. The electrical energy consumer's appliance was switched ON or OFF remotely during these peak times of electrical energy demand intervals according to the domestic electrical energy consumer's choice. After the peak electrical energy demand time interval is over the consumer's appliance was switched ON again. During this week the same principle of monitoring electrical energy consumption in real-time was used. The electrical energy consumption information was posted back to the demand-side control system based on five minute time intervals as it was done during the first two weeks. The data log for the third week of experimentation is presented in Appendix I (c). During this last week's experimentation it was possible to answer the question that whether or not domestic electricity consumers react to the information about their electrical energy consumption provided to them in real-time. It was also

possible to analyze if this kind of approach can help domestic electricity consumers to reduce their overall electricity consumption or even to shift some part of their load from peak times of electrical energy demand to off-peak times.

5 Results

5.1 Introduction

The implementation of the system developed for proof of concept purposes helped to draw results after basic testing. A domestic consumer's electrical energy consumption was monitored in real-time and was posted to the demand-side controller. A graphical user interface (GUI) was developed for issuing commands to the consumer's appliance to turn it ON or OFF. The proof of concept worked according to the expectations and helped to obtain results that are discussed in this chapter. Chapter 5 also analyses these results and concludes with some recommendations for the electricity utilities.

5.2 Findings week one

The first week of experimentation (as explained in Section 4.2.1) lasted for five days (from 07h00 in the morning of 06 December 2010 to 16h30 in the afternoon of 11 December 2010). Table 4 shows values calculated from the data presented in Appendix I (a). During the first week the domestic electrical energy consumer's normal electrical energy consumption behaviour (pattern) was monitored. These consumption intervals are divided into two main groups called 'consumption during peak time' and 'consumption during off-peak time' as shown in Table 4. The price that is used to calculate the amount for the consumption during the off-peak time is assumed as R. 0.45 per kWh (approximate values taken from Eskom tariffs). The price charged for the consumption during the peak time of electrical energy demand is twenty percent more than the price for off-peak time (that is R. 0.54 per kWh).

Table 4: Findings week one

From 07:00 of Dec 06 to 16:30 of 11 Dec 2010

Date	Consumption during peak time (mins)	Consumption during peak time (kWh)	Consumption during off-peak time (mins)	Consumption during off-peak time (kWh)	Rate During peak time (per kWh)	Rate During off-peak time (per kWh)	Total Consumption(kWh)	Amount in Rand
Day 1 Monday 06 Dec 2010	245	2,45	270	2,7	0,5406	0,4505	5,15	R2,54
Day 2 Tuesday 07 Dec 2011	195	1,95	415	4,15	0,5406	0,4505	6,1	R2,92
Day 3 Wednesday 08 Dec 2012	190	1,9	430	4,3	0,5406	0,4505	6,2	R2,96
Day 4 Thursday 09 Dec 2013	170	1,7	425	4,25	0,5406	0,4505	5,95	R2,83
Day 5 Friday 10 Dec 2014	220	2,2	430	4,3	0,5406	0,4505	6,5	R3,13
Day 6 Saturday 11 Dec 2015 (No peak times on a Saturday)	0	0	425	4,25	0,5406	0,4505	4,25	R1,91
Total Electricity Consumption (kWh) @ 600 Watt:							34,15	
Total Amount for the week:								R16,30

Table 4 shows the breakdown of total electrical energy consumption (in kWh) during the off-peak and peak time of electrical energy demand on a daily basis. It also calculates the amount charged to the domestic electrical energy consumer against his/her electrical energy consumption. The domestic electrical energy consumer consumed 34.15 kWh of energy during this week. The domestic electrical energy consumer consumed 29.87 percent of its total electrical energy consumption during the peak time of electrical energy demand (this is shown in Figure

6). This 29.87 percent usage cost him/her twenty percent more than what it costs during the off-peak time of electrical energy demand. The total amount (cumulative amount for consumption during peak and off-peak time of electrical energy demand) for that appliance is R. 16.30.

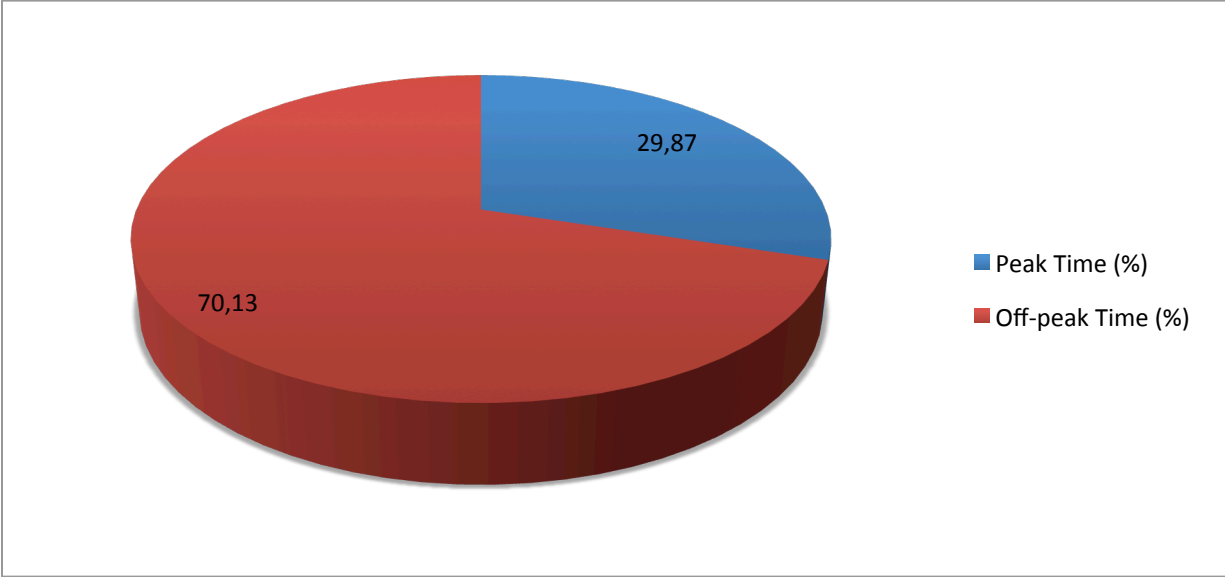

Figure 6: Week 1 - Percentage of consumption breakdown during peak time and off-peak time of electrical energy demand

5.3 Findings week two

The second week of experimentation was designed to simulate the effect of full control given to the electricity utilities over a domestic consumer’s electrical energy consumption. During the experiment for second week it was made sure that the domestic electricity consumer’s appliance was kept OFF during the peak times of electrical energy demand. The electrical energy consumption was monitored in real time and was stored on demand side control system. Table 5 shows the information obtained from the data attached in Appendix I (b).

Table 5: Findings week two

From 07:00 of Jan 10 to 16:30 of 15 Jan 2011

Date	Consumption during peak time (mins)	Consumption during peak time (kWh)	Consumption during off-peak time (mins)	Consumption during off-peak time (kWh)	Rate During peak time (per kWh)	Rate During off-peak time (per kWh)	Total Consumption(kWh)	Amount in Rand
Day 1 Monday 10 Jan 2011	0	0	335	3,35	0,5406	0,4505	3,35	1,509175
Day 2 Tuesday 11 Jan 2011	0	0	475	4,75	0,5406	0,4505	4,75	2,139875
Day 3 Wednesday 12 Jan 2011	0	0	495	4,95	0,5406	0,4505	4,95	2,229975
Day 4 Thursday 13 Jan 2011	0	0	555	5,55	0,5406	0,4505	5,55	2,500275
Day 5 Friday 14 Jan 2011	0	0	575	5,75	0,5406	0,4505	5,75	2,590375
Day 6 Saturday 15 Jan 2011 (No peak times on a Saturday)	0	0	480	4,8	0,5406	0,4505	4,8	2,1624
Total Electricity Consumption (kWh) @ 600 Watt:							29,15	
Total Amount for the week:								13,13208

It is clearly shown in Table 5 that there is no electrical energy consumption during the peak time of electrical energy demand (hence zero percent electrical energy consumption during peak-times of electrical energy demand as shown in figure 7). The total electrical energy consumption during the second week is 29.15 kWh, which is 14.64 percent less than the first week of electrical energy consumption. This 14.64 percent less usage of electrical energy is because there is no electrical energy usage during the peak times of electrical energy demand. This week simulates the effect of change in electrical energy consumption pattern in case where electricity utilities have full control over the domestic electrical energy consumer's consumption. A 19.45 percent reduction in cost of total energy consumed has also been noticed during this second week of experiment. This 19.45 percent reduction is more prominent reduction than the reduction in the overall energy consumption. This difference is because of the difference in cost of electrical energy between peak and off-peak demand time of electrical energy.

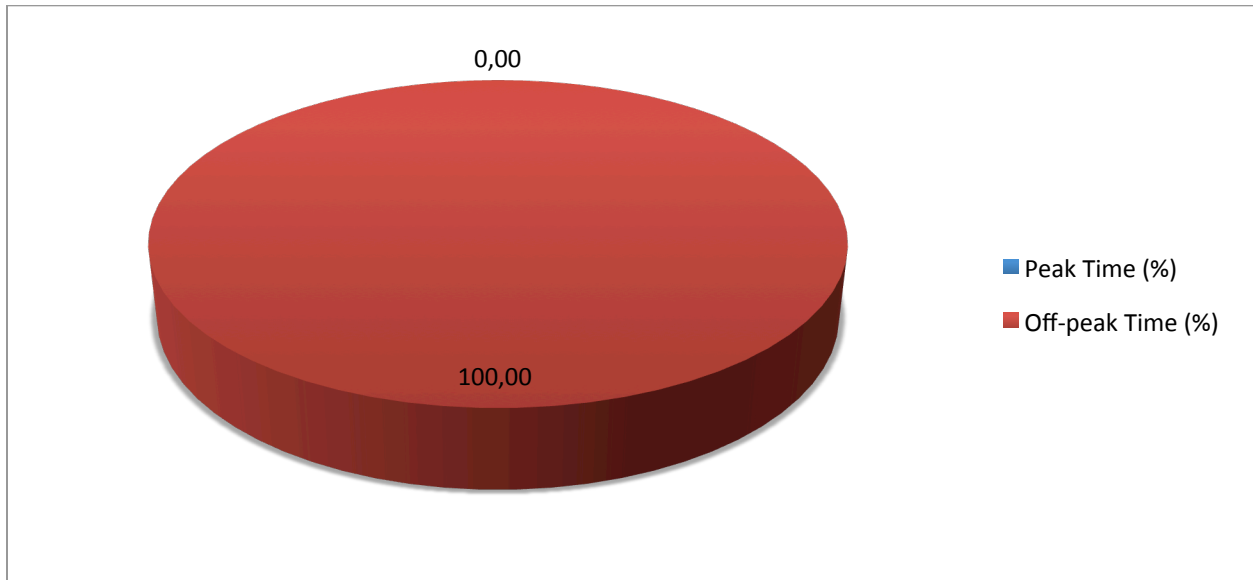

Figure 7: Week 2 –Percentage of consumption breakdown during peak time and off-peak time of electrical energy demand

5.4 Findings week three

During the third week the electrical energy consumption of domestic electricity consumer was monitored and stored (stored in database running on demand side control system) in real time. The consumer was sent an SMS if his/her appliance was found switched ON during the peak time of electrical energy demand. The SMS was to alert consumer that the consumption made during the peak time of electrical energy demand is costing twenty percent more than the off-peak time electrical energy demand. Consumer was also asked if (s)he want to switch his/her appliance ON or OFF during the peak electrical energy demand time.

Table 6: Findings week three

From 07:00 of Jan 17 to 16:30 of 22 Jan 2011

Date	Consumption during peak time (mins)	Consumption during peak time (kWh)	Consumption during off-peak time (mins)	Consumption during off-peak time (kWh)	Rate During peak time (per kWh)	Rate During off-peak time (per kWh)	Total Consumption(kWh)	Amount in Rand
Day 1 Monday 17 Jan 2011	85	0,85	290	2,9	0,5406	0,4505	3,75	1,77
Day 2 Tuesday 18 Jan 2011	10	0,1	194	1,94	0,5406	0,4505	2,04	0,93
Day 3 Wednesday 19 Jan 2011	110	1,1	475	4,75	0,5406	0,4505	5,85	2,73
Day 4 Thursday 20 Jan 2011	120	1,2	515	5,15	0,5406	0,4505	6,35	2,97
Day 5 Friday 21 Jan 2011	140	1,4	535	5,35	0,5406	0,4505	6,75	3,17
Day 6 Saturday 22 Jan 2011 (No peak times on a Saturday)	0	0	500	5	0,5406	0,4505	5,00	2,25
Total Electricity Consumption (kWh) @ 600 Watt:							29,74	
Total Amount for the week:								13,82

Table 6 (derived after calculations on data in Appendix I (c)) shows that the electrical energy consumption for the week is 29.74 kWh (15.64 percent out of 29.74 kWh is during the peak-

times of electrical energy demand as shown in Figure 8). In terms of electrical energy usage this is 12.91 percent less than the first week in which electrical energy consumer had no mean to observe how much electrical energy is he/she is consuming. However, during the third week domestic electrical energy consumer consumed approximately 2.02 percent more electrical energy than the second week. This 2.02 percent increase in the third week is the increase in over all energy, which is sum of peak time of energy demand and off-peak time of electrical energy demand.

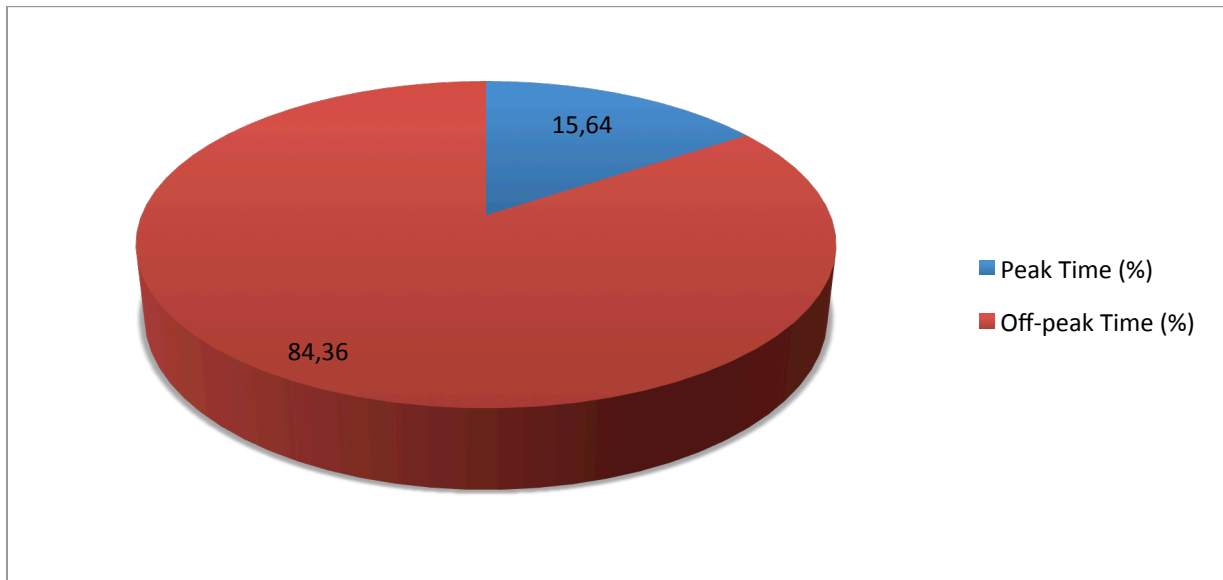

Figure 8: Week 3 - Percentage of consumption breakdown during peak time and off-peak time of electrical energy demand

5.5 Discussion and performance analysis

Change in electrical energy consumption pattern during three weeks of testing has been discussed in the previous section. This section summarizes those results and discusses the reasons for the differences in the findings for all three weeks. Table 7 and Figure 9 shows the summary of findings presented in Table 4, Table 5, and Table 6. Table 8 shows a comparison between findings for all three weeks that has been presented in Table 7 and Figure 9.

Table 7: Summary of findings for all three weeks

Week	Consumption during peak time (kWh)	Consumption during off-peak time (kWh)	Amount for the consumption during peak time	Amount for the consumption during off-peak time	Total Consumption (kWh)	Total Amount in Rand
Week One	10,20	23,95	R5,51	R10,79	34,15	R16,30
Week Two	0,00	29,15	R0,00	R13,13	29,15	R13,13
Week Three	4,65	25,09	R2,51	R11,30	29,74	R13,82

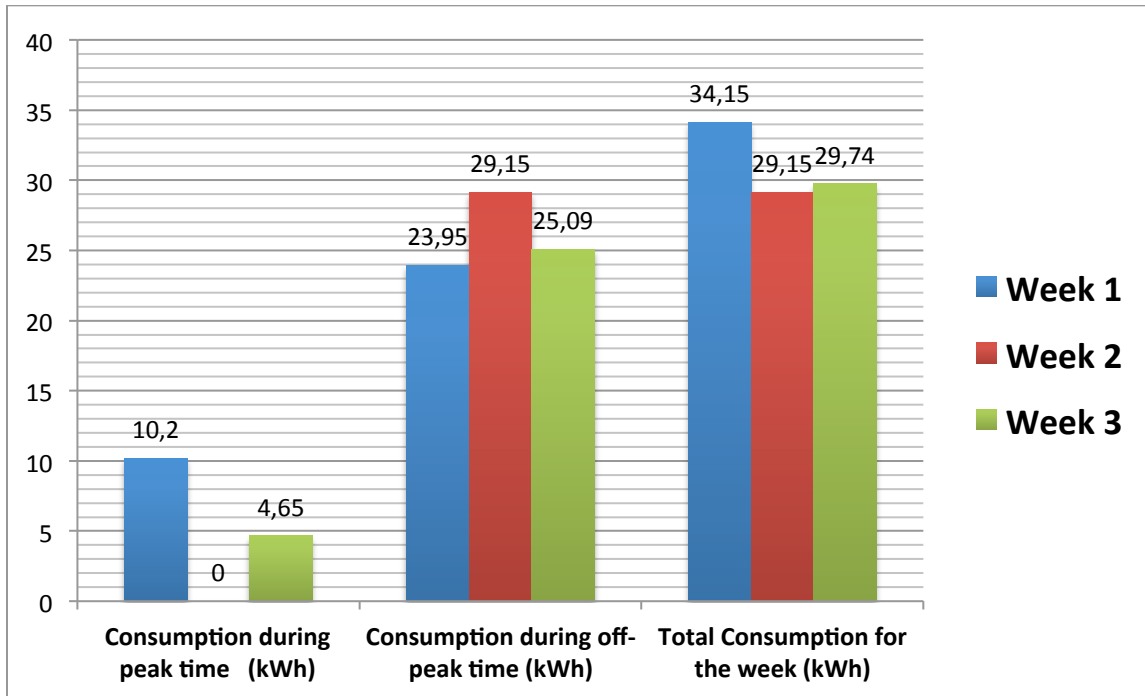

Figure 9: Summary of findings for all three weeks (with respect to consumption)

5.5.1 Analysis with respect to consumption

In the second week there is a 100 percent decrease in electrical energy consumption from first week (during the hours of peak electrical energy demand only). This decrease is because during the second week it was made sure that the appliance is kept OFF during the peak hours of electrical energy demand. In third week domestic electrical energy consumer was alerted about his/her electrical energy consumption (during the peak hours of electrical energy demand). These alerts encouraged the consumer to reduce his/her electrical energy consumption during the peak hours of electrical energy demand. Table 8 clearly indicates that domestic electrical energy consumer was able to cut down his/her electrical energy consumption approximately by 54.41 percent. Comparison between week 2 and week three indicates that week three consumed 100 percent more electrical energy during the peak hours of electrical energy demand. This is because there was no electrical energy consumption during the second week for peak times of electrical energy demand.

Table 8: Performance analysis

Performance Analysis	Week 1 VS Week 2	Week 1 VS Week 3	Week 2 VS Week 3
With respect to consumption			
Reduction/Increase in consumption during peak times	100,00	54,41	-100,00
Reduction/Increase in consumption during off-peak times	-21,71	-4,76	13,93
Total reduction/increase in consumption	14,64	12,91	-2,02
With respect to price			
Reduction/Increase in cost during peak times	100,00	54,41	-100,00
Reduction/Increase in cost during off-peak times	-21,71	-4,76	13,93
Total reduction/increase in cost	19,45	15,25	-5,21

<p>Legend: + Percentage decrease - Percentage increase</p>

In terms of change in electrical energy consumption pattern during the off-peak times of electrical energy demand there are changes noticed in all three weeks of experimentation. Comparing week one and week two there is approximately 21.71 percent of increase in week two during the off-peak hours of electrical energy demand. This increase in consumption is because there was no electrical energy consumption during the peak hours of electrical energy demand for the second week. We can assume that this increase during the off-peak hours of electrical energy demand is a shift from peak hours of electrical energy demand. Week three (when domestic electrical energy consumer was alerted during the peak times of electrical energy demand) in comparison with week one has consumed 4.75 percent less electrical energy during the off-peak times of electrical energy demand. Comparing week three with week two also shows results in decrease of electrical energy consumption during the off-peak times of electrical energy demand. A decrease of 13.92 percent has been noticed during the week three in comparison with week one.

Comparing the total electrical energy consumption (sum of peak and off-peak times of electrical energy demand) the results in general are still on the lower side. During week two of testing, domestic electrical energy consumer consumed 14.64 less electrical energy from week one in terms of total electrical energy consumption. This is because there was no electrical energy consumption during the peak time of electrical energy consumption for week two. In week three (with respect to week one) 12.91 percent reduction in total electrical energy consumption has been noticed. However, a 2.02 percent increase in overall electrical energy consumption between week two and week three has been noticed. This increase is because week three has consumed some of the electrical energy (4.65 kWh) during the peak times of electrical energy demand where as week two consumed no electrical energy during the peak times of electrical energy demand.

5.5.2 Analysis with respect to price

Section 5.5.1 discussed the performance analysis on the data obtained over the three weeks of testing with respect to the electrical energy consumption patterns. This section discusses the effect of the change in pattern of electrical energy consumption with respect to the cost factor. Numbers presented in Table 8 suggest that the percentage of change in the cost factor (increase/decrease) is similar to the percentage amount of electrical energy consumption for peak and off-peak times of electrical energy demand. However, the numbers are different for the total reduction/increase in cost and consumption.

In terms of total electrical energy consumption week two consumed 14.64 percent less electrical energy as compared to week one. In contrast to the use of less electrical energy the reduction in price for week two is 19.45 percent. This reduction in cost is more because during week two there was no electrical energy consumption during the peak times of electrical energy demand however, week one consumed 29.87 percent of its total electrical energy consumption during the peak times of electrical energy demand. The consumption made (in week one) during the peak times of electrical energy demand costs 20 percent more than the consumption during the off-peak times of electrical energy demand. Since during week two the total electrical energy consumption was during the off-peak times of electrical energy demand, the cost in reduction is greater than week one.

For week three the total electrical energy consumption is 12.91 percent less than the week one. However, the reduction in cost for week three is 15.25 percent that is more than the rate of reduction in electrical energy consumption. This more reduction in cost is because during week one the domestic electrical energy consumer unknowingly consumed 10.20 kWh of its total electrical energy during the peak times of electrical energy demand. This 10.20 kWh is 29.87 percent of its total electrical energy consumption for the week one. On the other hand during week three the domestic electrical energy consumer was alerted during the peak times of electrical energy demand. These alerts made it easier for the domestic electrical energy consumer to react on the information provided to them in a timely manner. Because of this timely reaction the domestic electrical energy consumer consumed only 4.65 kWh during the peak times of electrical energy demand in week three. This 4.65 kWh is 15.66 percent of the total electrical energy consumption for week three. This reduction during the peak time of electrical energy consumption cost less during week three.

Comparing the results of week two and week three there is a difference in rate of change of total electrical energy consumption and cost for these two weeks. Week three consumed 2.02 percent more electrical energy than week two. This greater usage of electrical energy consumption cost 5.21 percent more in week three. This is because week two has no electrical energy consumption during the peak times of electrical energy demand whereas, week three has consumed 15.63 percent of its total electrical energy consumption during the peak times of electrical energy

demand. This usage during the peak times of electrical energy demand in week three cost 20 percent more than week two.

5.5.3 Analysis with respect to alert/response log

This section analyzes the reaction of the domestic electrical energy consumer against the alerts sent to him/her about his/her electrical energy consumption. The domestic electrical energy consumer was alerted during the third week via the SMS technology on their cell phones. These alerts were sent to the consumer if his/her appliance was found switched ON during the peak times of electrical energy demand. The domestic electrical energy consumer was also asked (in the same alert message) if they want to switch his/her appliance OFF during this peak time of electrical energy demand. This information enabled domestic electrical energy consumer to decide if he/she wanted to pay twenty percent more for his/her electrical energy consumption during the peak time of electrical energy demand.

Table 9: Alert / response log

Date	SMS	Response	Command	Response Time (in mins)
17 January 2011 at 07:00	Alert	No response	Null	NA
17 January 2011 at 16:00	Alert	Yes	Switch off	2
18 January 2011 at 07:04	Alert	Yes	Switch off	5
18 January 2011 at 16:07	Alert	Yes	Switch off	0
19 January 2011 at 06:58	Alert	Yes	Keep switched On	21
19 January 2011 at 16:01	Alert	Yes	Switch off	40
20 January 2011 at 06:57	Alert	Yes	Switch off	14
20 January 2011 at 16:02	Alert	Yes	Keep switched On	1
21 January 2011 at 07:01	Alert	Yes	Switch off	20
21 January 2011 at 16:02	Alert	No response	Null	NA

Table 9 shows the log of these alerts sent to the domestic electrical energy consumer and his/her reaction. It also recorded the amount of time that he/she took to react to the alert sent to him/her. During this period of experimentation the domestic electrical energy consumer was alerted ten times. He/she replied eight times out of these ten times, which makes it eighty percent response time. Out of these eight times the domestic electrical energy consumer asked six times to switch his/her appliance OFF for the period of peak times of electrical energy demand. On two occasions during this week he/she asked not to switch his/her appliance OFF during the peak times of electrical energy demand. From these numbers it can be concluded that the domestic electrical energy consumer's response rate was eighty percent. It was six times (seventy five percent) when the consumer wanted to shift his/her load from peak times to off-peak times of electrical energy demand.

In terms of reaction time the domestic electrical energy consumer's response time varied from immediate response to a delayed response up to forty minutes. These delays in response time can

have a noticeable effect on domestic electrical energy consumer's overall cost for his/her electrical energy consumption. This can also be a potential problem for the electricity utility in case there is a system instability threat.

5.5.4 Recommendations for the electricity utilities

After critically analyzing the findings for all three weeks it is recommended that electricity utilities should deploy domestic consumer based demand response programs. One could argue that during week two there was maximum reduction recorded however, the week two simulates a utility driven demand response program. Domestic electrical energy consumer had no control over their electrical energy consumption during week two. Electricity utility made sure that the appliance was kept OFF all the time during the peak times of electrical energy demand.

On the other side during week three, domestic electrical energy consumer clearly consumed 2.02 percent more electrical energy than week two. However, this difference is very small that it can be neglected because of considering its benefits. Consumer satisfaction can be achieved by giving domestic electrical energy consumers more control over their electrical energy consumption pattern. In case of an emergency where system stability is under threat electricity utilities can always takeover and control domestic consumer's electrical energy consumption.

In this study it is recommend that electricity utilities should offer domestic electrical energy consumers driven demand response programs. They should only takeover in case of a system emergency or overall system reliability threat.

6 Conclusion and Future Work

Domestic electrical energy consumers currently have no or very little role to play in power grid operations. Research has proven its effectiveness when consumers have participated in system operations. It is becoming very important to find and deploy means of green energy usage. Green energy resources at the moment are expensive and they are also not compatible to become an integral part of current electrical grid infrastructure. At present it is also not possible to store electrical energy in big quantities for future usage efficiently and effectively. Smart grid is the ultimate solution for all of these problems however, technologies required to deploy a smart grid are expensive at the moment and they are also not very mature yet. Smart grid deployment till today has also not yet proven their effectiveness. Considering all these challenges with smart grid technologies and concepts it is becoming very important to find alternative means to reduce over all electrical energy consumption. Demand response programs can be used effectively to reduce electrical energy consumption. These programs can also be used to achieve reliability and stability in electrical grid system's operation. Electricity utilities around the World have deployed demand response programs to achieve their system reliability and stability.

Most of these demand response programs are predominantly for the large consumers class like enterprises or commercial electrical energy consumers. Literature surveys and previous research has shown that the domestic electrical energy consumers waste a big part of electrical energy. This wastage is because domestic electrical energy consumers had no mean to monitor their electrical energy consumption in real time. This is one of the prime reasons that domestic electrical energy consumers waste electrical energy unknowingly. Research has proven that domestic electrical energy consumers can reduce their electrical energy consumption when they are provided with the electrical energy consumption information. Smart meters have been used to provide domestic electrical energy consumers with the feedback about their electrical energy consumption. However, the domestic electrical energy consumers have to be onsite to benefit from the information presented on smart meter. This makes the use of smart meter inefficient because in most of cases domestic electrical energy consumers are not at home all the time. System based on the concept of smart socket as been proposed in this report has the potential to alert domestic electrical energy consumers about their electrical energy consumption during the peak time of electrical energy demand or when required. It can also enable the domestic electrical energy consumer to control their electrical energy consumption irrespective to their geographical location. This system has been developed and discussed in this report for the purpose of the proof of concept of the principle that, domestic electrical energy consumers can reduce their electrical energy consumption or shift their load from peak time of electrical energy demand to off-peak time of electrical energy demand if, they are provided with the information about their electrical energy consumption timely, and tools to control their electrical energy consumption remotely. The system has been tested over three weeks with different scenarios and it has proven its effectiveness. After analyzing the results generated from the data obtained with

the usage of system in a domestic consumer's household it is concluded that such systems can work effectively. It is also possible to deploy domestic electrical energy consumers based demand response programs with the use of such system. The proposed system has also proved that domestic electrical energy consumers do react to their electrical energy consumption information provided to them in timely manner. It is also proven that when domestic electrical energy consumers were alerted with their electrical energy consumption information they were able to reduce their electrical energy consumption or even they shifted their load from peak time of electrical energy demand to off-peak time of electrical energy demand. The principle has proven its purpose and can be proposed to electricity utilities to use it for offering consumer based demand response programs.

6.1 Future work recommendations

Consumer based demand-side energy management system using the concept of smart sockets has been discussed in this report. The effectiveness of this system has been proven with results. Following are the recommendations that can be used to enhance the capabilities of the system:

- Authentication management system under the part of demand-side control system can be implemented.
- Demand-side management policies component need to be developed.
- Smart sockets based system has been tested in one domestic consumer's household environment. It can be tested with multiple domestic consumers household to verify its effectiveness.

7 References

- [1] Intermediate Energy Info Book 2007, the Need Project, Page No. 42
- [2] Nouredine Hadjsaid, and Jean-Claude Sabonnadiere, Power Systems and Restructuring
- [3] U.S. Department of Energy, The Smart grid: An Introduction (Washington, DC: U.S.Energy), Published in 2008, Online available at <http://www.oe.energy.gov/1165.htm> [Last viewed on May 02, 2012]
- [4] European Smart Grids Technology and Strategy for Europe's Electricity future. Online available at http://ec.europa.eu/research/energy/pdf/smartgrids_en.pdf , Published in 2006, [Last viewed on May 02, 2012]
- [5] Zhang Ruihua ; Du Yumei ; Yuhong Liu, New Challenges to Power System Planning and Operation of Smart Grid Development in China, Power System Technology (POWERCON), 2010, ISBN: 978-1-4244-5938-4
- [6] Rusitschka, S. ; Gerdes, C. ; Eger, K. Energy Market, 2009. EEM 2009. 6th International Conference on the European, ISBN: 978-1-4244-4455-7
- [7] Mak, S.T, A Synergistic Approach to Implement Demand Response, Asset Management and Service Reliability Using Smart Metering, AMI and MDM Systems, Power & Energy Society General Meeting, 2009. PES '09. IEEE, ISBN: 978-1-4244-4241-6
- [8] Shayesteh, E. ; Moghaddam, M.P. ; Taherynejhad, S. ; El Eslami, M.K.S, Congestion Management Using Demand Response Programs in Power Market, Power and Energy Society General Meeting - Conversion and Delivery of Electrical Energy in the 21st Century, 2008 IEEE, ISBN: 978-1-4244-1905-0
- [9] Davidson, I.E, Anticipating the Expansion of Power Facilities in Africa to meet Increasing Demand for Electricity, Power Engineering Society Inaugural Conference and Exposition in Africa, 2005 IEEE, ISBN: 0-7803-9326-0
- [10] Du Plessis, I., Electricity generation and transmission in South Africa by 2020: an Eskom planning perspective, IEEE AFRICON 4th, 1996, pp. 1127 - 1132 vol.2
- [11] Eskom.co.za, Understanding Electricity, Online available at <http://www.eskom.co.za> [Last viewed on 9th February 2010]
- [12] Eskom, online available at <http://www.eskom.co.za/content/2008EskomPoster.jpg> [Last viewed on May 02, 2012]

- [13] The Economist, Online available at http://www.economist.com/world/displaystory.cfm?story_id=10609230 , Published on 31st January 2008 [Last viewed on May 02, 2012]
- [14] San Diego Smart Grid Study Final Report, Online available at http://www.sandiego.edu/epic/research_reports/documents/061017_SDSmartGridStudyFINAL.pdf Published in 2006 [Last viewed on May 02, 2012]
- [15] The White house home page, Online available at <http://www.whitehouse.gov/issues/energy-and-environment/> [Last viewed on May 02, 2012]
- [16] Recovery Act in Clean Energy, Online available at http://energy.gov/sites/prod/files/RecoveryActSuccess_Jan2012final.pdf Published in January 2012, [Last viewed on May 02, 2012]
- [17] Energy.Gov, Online available at <http://www.energy.gov/news/10332.htm> [Last viewed on May 19, 2011]
- [18] Smart Grid in California, California Public Utilities Commission, Online available at http://www.epa.gov/statelocalclimate/documents/pdf/zafar_presentation_electricity_grid_12-17-2008.pdf Published on 17th December 2008 [Last viewed on May 19, 2011]
- [19] Smart Grid Australia, Online available at http://www.smartgridaustralia.com.au/uploads/documents/SGA_R&D_flyer.pdf [Last viewed on May 19, 2011]
- [20] The Minimum Emission Region Project (MEREGIO), Online available at <http://www.im.uni-karlsruhe.de/Default.aspx?PageId=470&lang=en> [Last viewed on May 02, 2012]
- [21] The Swedish Energy Agency, Online available at <http://www.energimyndigheten.se/en/Press/Press-releases/The-Swedish-Energy-Agency-grants-SEK-940000-for-the-GoalArt-smart-grid-project/> Published on 20th January 2011, [Last viewed on May 02, 2012]
- [22] Details about international smart grid projects, Online available at <http://www.sgiclearinghouse.org/International> [Last viewed on May 02, 2012]
- [23] A System View of the Modern Grid, A report prepared by National Energy Technology Laboratory for the U.S. Department of Energy, Online available at http://www.netl.doe.gov/smartgrid/referenceshelf/whitepapers/ASystemsViewoftheModernGrid_Final_v2_0.pdf [Last viewed on May 02, 2012]

- [24] Green Wombat, IBM to build world's first national smart utility grid, Online available at <http://thegreenwombat.com/2009/02/04/ibm-to-build-worlds-first-national-smart-utility-grid/> Published on 4th February 2009, [Last viewed on May 02, 2012]
- [25] Eric Lightner And Rich Scheer, iMoving From Concept to Reality, The Smart Grid Will Revolutionize The Way People Buy, Sell, and Use Electricity, Electric Perspectives, November/December 2008, pp. 73 - 81.
- [26] The effectiveness of feedback on energy consumption, A review for DEFRA of the Literature on metering, billing, and direct displays, Online available at <http://www.eci.ox.ac.uk/research/energy/electric-metering.php> [Last viewed on May 02, 2012]
- [27] Dobbyn and Thomas 2005, p26
- [28] Electric Power Research Institute (EPRI), 2009, Residential Electricity Use Feedback: A Research Synthesis and Economic Framework, Online available at , http://opower.com/uploads/library/file/4/residential_electricity_use_feedback.pdf Published in 2009, [Last viewed on May 02, 2012]
- [29] Smart Meters, Ministerial Council on Energy, Australia, Jan 2007.
- [30] Depuru, S.S.S.R. ; Lingfeng Wang ; Devabhaktuni, V. ; Gudi, N, Smart Meters for Power Grid – Challenges Issues, Advantages and Status, Power Systems Conference and Exposition (PSCE), 2011 IEEE/PES, ISBN: 978-1-61284-789-4
- [31] Boshell, F.; Veloza, O.P, Review of developed demand side management programs including different concepts and their results, Transmission and Distribution Conference and Exposition: Latin America, 2008 IEEE/PES, ISBN: 978-1-4244-2217-3
- [32] California Energy Commission, "Energy Efficiency and Conservation: Trends and Policy Issues", California, USA, Tech. Rep., May. 2003, Online Available at: http://www.energy.ca.gov/reports/2003-05-29_100-03-008F.PDF Published in May 2003, [Last viewed on May 02, 2012]
- [33] D. Caves, K. Eakin, and A. Faruqui, Mitigating price spikes in wholesale markets through market-based pricing in retail markets, The Elect.J., vol. 13, no. 3, pp. 13-23, Apr. 2000
- [34] Azami, R. ; Fard, A.F, Impact of demand response programs on system and nodal reliability of a deregulated power system, Sustainable Energy Technologies, 2008. ICSET 2008. IEEE International Conference, ISBN: 978-1-4244-1887-9
- [35] A report to Congress on: Assessment of Demand Response and Advance Metering, Federal Energy Regulation Commission, US Department of Energy, Online available at

<http://www.ferc.gov/legal/staff-reports/demand-response.pdf> Published in August 2006, Revised in December 2008, [Last viewed on February 13, 2012]

[36] Caves, D.W. ; Herriges, J.A. ; Hanser, P. ; Windle, R.J, Load impact of interruptible and curtailable rate programs: evidence from ten utilities [tariff incentives], Power Systems, IEEE Transactions on November 1988 Page 1757 – 1763, ISSN : 0885-8950

[37] Azami, R. ; Abbasi, A.H. ; Shakeri, J. ; Fard, A.F, Impact of EDRP on composite reliability of restructured power systems, PowerTech, 2009 IEEE Bucharest, ISBN: 978-1-4244-2234-0

[38] A Survey Of Time-Of-Use (Tou) Pricing And Demand-Response (Dr) Programs, commissioned by U.S. Energy Environmental Protection Agency (U.S. EPA), Online available at <http://sedc-coalition.eu/wp-content/uploads/2011/05/E3-Survey-of-Dynamic-Pricing-Programs-Jun-2006.pdf> Published in July 2006, [Last viewed on February 13, 2012]

[39] ITU, Online available at http://www.itu.int/ITU-D/ict/statistics/at_glance/KeyTelecom.html Published on 16th November 2011, [Last viewed on Feb 10, 2012]

[40] Nguyen, D.; Negnevsky, M.; Danchi Jiang; de Groot, M, A model of domestic energy management enabling low-cost technology, Power Engineering Conference, 2008. AUPEC '08. Australasian Universities, ISBN: 978-0-7334-2715-2

[41] Abdullah, M.M.; Dwolatzky, B, Demand-side energy management performed using direct feedback via mobile systems: Enables utilities to deploy consumer based demand response programs, Energy Conference and Exhibition (EnergyCon), 2010 IEEE International, ISBN: 978-1-4244-9378-4

[42] US DOE February 2006 EPAct Report, 7, Online available at www.narucmeetings.org/Presentations/mansueti%20goldman.ppt Presented on 2nd August 2006, [Last viewed on May 02, 2012]

[43] Gordon Rugg & Marian Petre, A Gentle Guide to Research Methods

[44] Arduino: An open source electronic prototyping platform, Online available at <http://www.arduino.cc>, [Last viewed on May 02, 2012]

[45] Open Energy Monitor, “A project to develop and build open source energy monitoring and analysis tools”, Online available at <http://web.archive.org/web/20110521185012/http://openenergymonitor.org/emon/node/59> [Last viewed on May 02, 2012]