

**Perceived mobile interactivity influence on usability and mobile marketing
acceptance in the informal hair-care business**

Valencia Melissa Zulu

A research report submitted to the Faculty of Commerce, Law and Management,
University of the Witwatersrand, in partial fulfilment of the requirements for the
degree of Master of Management in Strategic Marketing

Johannesburg, 2016

ABSTRACT

The African hair-care business has become a multibillion-dollar industry, stretching from India to China attracting global retailers such as Unilever and L'Oréal. The African hair-care market will continue to grow, especially in the informal sector where it is said to employ about 1.5 people per business on permanent basis.

In order for small businesses' performance to improve in emerging markets, especially in the informal sector, improving their marketing skills is quite essential. Mobile marketing is cost effective and can be utilised to benefit both marketing practitioners and consumers. This is imperative in the informal hair-care industry, where businesses generally lack financial resources and therefore do not have a budget to spend on marketing and advertising.

The mobile phone therefore becomes an important marketing channel to reach customers and increase profitability in informal hair-care businesses, yet there has not been much academic research conducted on this and little is known about the factors that might influence mobile marketing acceptance. The purpose of this study is therefore to bridge the gap by investigating perceived mobile interactivity influence on usability and mobile marketing acceptance in the informal hair-care industry in South Africa.

A quantitative study was conducted using a sample of 312 informal hair-care business operators in the Johannesburg area. Given the nature of the informal sector, a nonprobability sampling method, known as convenience sampling, was used for data collection. For analysing and interpreting data, Structural Equation Modelling (SEM) approach was utilised. The study findings indicate that perceived interactivity dimensions (control, responsiveness and nonverbal information) have a positive effect on mobile phone usability and lead to mobile marketing acceptance. However, the findings showed a negative relation between perceived personalisation and mobile phone usability. This study aims to contribute to mobile marketing literature, be of benefit to Small, Medium and Micro-sized Enterprises (SMMEs) policy makers and add value to the field of marketing.

Key words: perceived control, perceived responsiveness, nonverbal information, perceived personalisation, mobile phone usability, mobile marketing acceptance

DECLARATION

I, _____, declare that this research report is my own work except as indicated in the references and acknowledgements. It is submitted in partial fulfilment of the requirements for the degree of Master of Business Administration in the University of the Witwatersrand, Johannesburg. It has not been submitted before for any degree or examination in this or any other university.

Signed at

On the day of 20.....

DEDICATION

I would like to dedicate this dissertation to the memory of my late sister, Fatima Mercia Zulu who has always inspired me to dream big and take on big challenges.

A special thanks to my lovely mom, Elsie Margaret Zulu for her wisdom and support. You are my pillar of strength and have always motivated me to carry on studying. This is dedicated mainly to you.

To the rest of my family, I would also like to express my profound appreciation to my sister, Sibongile Zulu, for being with me every step of this journey; you truly inspire me to be better. Lastly, to my little brother, Sizwe Zulu, thank you for staying up with me those late nights. I hope this work provides inspiration to you.

ACKNOWLEDGEMENTS

I would like to express my highest gratitude to my Supervisor, Professor Richard Chinomona for believing in me during the hardships experienced in this journey. I am grateful to have been mentored by you and your sense of motivation is dumbfounding.

To my classmates, thank you for all the support and those late nights. You have shown me that in life, you need others to succeed and teamwork is everything.

TABLE OF CONTENTS

ABSTRACT	ii
DECLARATION.....	iii
DEDICATION	iv
ACKNOWLEDGEMENTS	v
CHAPTER 1. OVERVIEW OF THE STUDY.....	18
1.1 INTRODUCTION	18
1.2 CONTEXT OF THE STUDY	20
1.3 PROBLEM STATEMENT	24
1.3.1 MAIN PROBLEM	25
1.3.2 SUB-PROBLEMS	25
1.4 RESEARCH OBJECTIVES.....	25
1.4.1 THEORETICAL OBJECTIVES.....	25
1.4.2 EMPIRICAL OBJECTIVES	26
1.5 RESEARCH QUESTIONS.....	26
1.6 JUSTIFICATION OF THE STUDY	26
1.7 SIGNIFICANCE OF THE STUDY	27
1.8 DELIMITATIONS OF THE STUDY.....	28
1.9 DEFINITION OF TERMS	29
1.10 ASSUMPTIONS	30
CHAPTER 2. LITERATURE REVIEW	31
2.1 INTRODUCTION	31
2.2 THEORETICAL GROUNDING.....	31
2.2.1 THE THEORY OF PLANNED BEHAVIOUR (TPB)	31
2.2.2 THE TECHNOLOGY ACCEPTANCE MODEL (TAM).....	33
2.3 PERCEIVED INTERACTIVITY	35
2.3.1 PERCEIVED CONTROL.....	37
2.3.2 PERCEIVED RESPONSIVENESS	39
2.3.3 NONVERBAL INFORMATION.....	41
2.3.4 PERCEIVED PERSONALIZATION.....	43
2.4 MOBILE PHONE USABILITY	45
2.5 MOBILE MARKETING ACCEPTANCE	47
2.6 CONCEPTUAL MODEL.....	49
2.7 HYPOTHESIS DEVELOPMENT	50
2.7.1 PERCEIVED CONTROL AND MOBILE PHONE USABILITY	50
2.7.2 PERCEIVED RESPONSIVENESS AND MOBILE PHONE USABILITY	51
2.7.3 NONVERBAL INFORMATION AND MOBILE PHONE USABILITY	52

2.7.4	PERCEIVED PERSONALISATION AND MOBILE PHONE USABILITY	53
2.7.5	MOBILE PHONE USABILITY AND MOBILE MARKETING ACCEPTANCE	54
2.8	CONCLUSION OF LITERATURE REVIEW	56

CHAPTER 3. RESEARCH METHODOLOGY..... 58

3.1	RESEARCH PARADIGM/PHILOSOPHY	58
3.2	RESEARCH DESIGN	59
3.3	TARGET POPULATION AND SAMPLE	60
3.3.1	TARGET POPULATION	60
3.3.2	SAMPLING AND SAMPLING METHOD.....	60
3.4	DATA COLLECTION INSTRUMENT	62
3.5	DATA COLLECTION TECHNIQUE	64
3.6	DATA PROCESSING AND ANALYSIS	64
3.6.1	DATA PROCESSING.....	64
3.6.2	DATA ANALYSIS.....	65
3.7	VALIDITY AND RELIABILITY	66
3.7.1	VALIDITY.....	66
3.7.2	RELIABILITY	66
3.7.3	MODEL FIT	67
3.7.4	PATH MODELLING	67
3.8	DEMOGRAPHIC PROFILE OF RESPONDENTS.....	68
3.9	LIMITATIONS OF THE STUDY.....	68
3.10	ETHICAL CONSIDERATIONS.....	68
3.11	SUMMARY	69

CHAPTER 4. DATA ANALYSIS AND PRESENTATION OF RESULTS 70

4.1	INTRODUCTION	70
4.2	DESCRIPTIVE STATISTICS.....	70
4.2.1	PROFILE OF RESPONDENTS	70
4.2.2	SUMMARY OF SCALE ITEM RESULTS.....	75
4.3	RELIABILITY AND VALIDITY ASSESSMENT OF THE RESEARCH CONSTRUCTS.....	88
4.3.1	MEAN VALUE.....	88
4.3.2	STANDARD DEVIATION	89
4.4	ASSESSMENT OF MEASUREMENT INSTRUMENTS.....	89
4.4.1	RELIABILITY MEASUREMENTS.....	89
4.4.2	VALIDITY MEASUREMENTS	90
4.5	CONFIRMATORY FACTOR ANALYSIS (CFA).....	94
4.5.1	CFA MODEL.....	94
4.5.2	MODEL FIT TEST.....	96
4.6	PATH MODELLING	99
4.6.1	MODEL FIT ASSESSMENT (PATH MODEL)	100
4.7	RESULTS FOR HYPOTHESIS TESTING	101
4.7.1	HYPOTHESIS VERIFICATION	102
4.7.2	CONCLUSION REGARDING THE HYPOTHESES	103
4.8	SUMMARY OF THE RESULTS	104

CHAPTER 5. DISCUSSION OF THE RESULTS	105
5.1 INTRODUCTION	105
5.2 DISCUSSION PERTAINING TO HYPOTHESES.....	107
5.2.1 HYPOTHESIS 1 (H1): PERCEIVED CONTROL HAS A POSITIVE EFFECT ON MOBILE PHONE USABILITY IN THE INFORMAL HAIR-CARE BUSINESS	107
5.2.2 HYPOTHESIS 2 (H2): PERCEIVED RESPONSIVENESS HAS A POSITIVE EFFECT ON MOBILE PHONE USABILITY IN THE INFORMAL HAIR-CARE BUSINESS	107
5.2.3 HYPOTHESIS 3 (H3): NONVERBAL INFORMATION HAS A POSITIVE EFFECT ON MOBILE PHONE USABILITY IN THE INFORMAL HAIR-CARE BUSINESS	108
5.2.4 HYPOTHESIS 4 (H4): PERCEIVED PERSONALISATION HAS A POSITIVE EFFECT ON MOBILE PHONE USABILITY IN THE INFORMAL HAIR-CARE BUSINESS	108
5.2.5 HYPOTHESIS 5 (H5): MOBILE PHONE USABILITY HAS A POSITIVE EFFECT ON MOBILE MARKETING ACCEPTANCE IN THE INFORMAL HAIR-CARE BUSINESS	109
5.3 CONCLUSION	110
 CHAPTER 6. CONCLUSIONS & RECOMMENDATIONS.....	 111
6.1 INTRODUCTION	111
6.2 CONCLUSIONS OF THE STUDY.....	111
6.2.1 RESEARCH OBJECTIVES.....	111
6.2.2 HYPOTHESES STATEMENT	112
6.3 RECOMMENDATIONS	115
6.3.1 ACADEMIC IMPLICATIONS	116
6.3.2 MANAGERIAL IMPLICATIONS	116
6.4 SUGGESTIONS FOR FURTHER RESEARCH.....	119
 REFERENCES	 120
 APPENDIX A.....	 145
QUESTIONNAIRE	145

CHAPTER 1.OVERVIEW OF THE STUDY

1.1 Introduction

Technology has become a critical resource for marketing performance activities (Chong, Man & Zhang, 2011). It is suggested that the use of technology enhances corporate brand image and supports the value of the marketing activities through sharing of information (Pourpakchashm, 2015). A number of researchers propose that businesses need to use new technological opportunities to leverage more benefits and improve the quality of their service offerings (Hamidi & Safabakhsh, 2011). Additionally, the fast mobile phone adoption has been accompanied by an ascending curve in the mobile commerce industry (Pourpakchashm, 2015).

Global trends indicate that larger amounts of marketing budgets are increasingly being allocated to mobile marketing (Mobile Marketing Association, 2015). According to Cleff (2010), the use of mobile technology has endless possibilities in terms of consumer data collection and provides marketing practitioners to reach consumers anywhere, at any given time with customised offers. The evolution of mobile marketing as emphasised by Chinomona and Sandada (2013) is of benefit to both marketing practitioners and customers as marketing personnel are able to expand their customer base by accessing numerous customers of diverse characteristics and of different geographical settings, while customers benefit from the wide assortment of product and services from which to select.

Mobile marketing activities have been receiving increasing attention in recent marketing and business management literature (Chinomona, & Sandada, 2013; Öztaş, 2015; Ström, Vendel, & Bredican, 2014; Shankar & Balasubramanian, 2009; Varnali, & Toker, 2010). Both scholars and practitioners identify and acknowledge that mobile marketing activities have a potential impact on the acceptance of mobile marketing and consumer purchase (Chinomona & Sandada, 2013; Pourpakchashm, 2015). Mobile marketing can be utilised to create a long-term relationship with the consumers (Pourpakchashm, 2015). Thus, helping to increase the consumers' loyalty, as consumers perceive mobile marketing as a platform to interact with the service

provider (Pourpakchashm, 2015). Mobile marketing has the power to influence and enable good customer experience (Mobile Marketing Association, 2015).

According to the Mobile Marketing Association (2015), Mobile is increasingly a key marketing tool and will become one of the powerful media platforms in South Africa. However, in South Africa, there has been a small, yet rising migration of marketing spend from traditional to mobile marketing (Mobile Marketing Association, 2015). Despite these encouraging opportunities and growth predictions, mobile marketing acceptance literature has received little attention in the South African context (Chinomona & Sandada, 2013). Moreover, there have also been a significant growing number of studies investigating the effect of mobile marketing acceptance amongst consumers, but with great focus on the youth (Gao et al., 2013).

Conversely, there have been few studies conducted on mobile marketing acceptance especially from a firm's point of view, particularly in the informal sector. Little is known about mobile activities in the informal hair-care business and the entrepreneur's intention to adopt or accept mobile marketing as a channel to promote their product and services and engage with consumers. In future, these hair-care business entrepreneurs can utilise mobile marketing to reach out to numerous clients, yet little is known whether they use mobile marketing as a marketing tool, and if so, little research if any, has identified the impact of using mobile marketing as a tool to enrich informal hair-care businesses. Again, if they have accepted using mobile marketing, it is important to investigate what influences these entrepreneurs to accept or prefer this platform.

Therefore, comprehensive research about the influence of interactivity on mobile phone usability and mobile marketing acceptance amongst informal hair-care business entrepreneurs is essential. Such research will provide insights to Small, Medium and Micro-Sized Enterprises (SMMEs) policy makers and marketing practitioners in both telecommunications (including mobile device manufacturers) and the hair-care industry in terms of assisting in attracting, and customising mobile products and enable consumers to make use of mobile marketing as an effective alternative to the traditional marketing activities.

Given the lack of previous empirical work on this subject matter, the purpose of this research is to investigate perceived mobile interactivity and influence on usability and mobile marketing acceptance in the informal hair-care business in South Africa. The remainder of this study reviews the literature on the unified theory of technology acceptance model and theory of planned behaviour, and then proposes a conceptual study model and research hypothesis. Thereafter, this section is followed by research methodology, data analysis and presentation of results. The subsequent chapters provide the discussion of results and finally, the recommendations and suggestions for further research directions are highlighted.

1.2 Context of the study

In order for a country's economic growth to continue to flourish, it requires all business players to become economically active; such players also include the small businesses that operate in the informal sector. According to Turkina (2013), the informal economy is a large and universal sector that keeps on evolving, especially in developing countries where half to two-thirds of the population are economically active.

Guliwe (2013) affirms that in the South African economy, the informal sector contributed about 3 million jobs in 2013. Moreover, recent research conducted by the Finmark Trust has indicated that there are approximately six million small businesses in South Africa and the majority of these businesses are informal (Mahomed, 2015). These small businesses also offer about 11.3 million employment opportunities and thus, are significant players that need attention from various stakeholders (Mahomed, 2015). The small businesses included in these statistics are the hair-care services and therefore a crucial economic market (Guliwe, 2013). Mchombu (2000) acclaims by stating that there is a need to demonstrate that the jobs of tomorrow are likely to come from the activities of the small business industry.

Indeed, a sector of the service industry, the hair-care industry has played a progressively significant role in the services sector and it has become a huge, attractive business (Brown & Beale, 2008; Kéïta, Faye, Kané, Ndiaye, Traoré, & Coulibaly, 2005). With the increase in the living standards and the maintainable

altering patterns of individuals' lives, people, predominantly women, spend much more on cultivating their beauty to fulfil their roles successfully in numerous socio-economic categories (Wei, Lee, Chen & Wu, 2013). Hairdressing is a common method for individuals to show a well-presented face to the society (Kéïta et al., 2005). Hair-care mostly denotes services such as, hairstyles, haircuts, scalp massages, hair perming, and hair colour (Gerson, 1999). The hair-care industry has come to be a highly competitive sector in both a developing and developed economy, indicating that the hair-care business has important influence on the economy in both developing and developed nations (Aghassian, & Leveque, 2001; Brookes & Smith, 2009; Picot-Lemasson, Decocq).

The hair-care industry continues to grow in Africa; although still mainly based in the informal economy, the African hair-care business has become a multibillion-dollar industry, stretching from India to China and has attracted global retailers such as Unilever and L'Oreal (Bizcommunity, 2014). The African hair market is divided into two categories, namely, Wet Hair (relaxers, conditioners and shampoo) and Dry Hair (extensions, wigs and weaves). According to Dolan (2014), reliable statistics on the size of this market are difficult to find and not accurate, since a large part of it is traded in the informal economy. However, Euromonitor International, a market research firm, has estimated that about R12.1 billion worth of relaxers, hair lotions and shampoos were sold in South Africa, Cameroon and Nigeria just in 2013 alone (Dolan, 2014). This justifies research findings by Webb, Bruton, Tihanyi, and Ireland (2013) who emphasise that the informal sector plays a significant role in economic and institutional development.

Research findings by Bertrand de Laleu, Managing Director of L'Oreal SA, show that while it is common for black South Africans to change hairstyles often, it seems in West Africa, change of hairstyle is even more trendy (Dolan, 2014). Moreover, Bertrand de Laleu mentions, "African women are probably the most daring when it comes to hairstyles", which makes the demand for hair-care even higher (Dolan, 2014). According to News24 (2014), in 2010 the global hair-care product market was estimated to have hit sales of R750 billion. South African's black hair-care business was projected to be valued at R9.7 billion a year, and was considered by the Professional Hair-care Market SA 2010 report as the largest in Africa (News24, 2014).

As a result, the hair-care business is a vital source of employment for many entrepreneurs, especially women and the clients are mainly females (Browne, 2006; Wingfield, 2009; Dant, Brush & Iniesta, 1996; Linnan & Ferguson, 2007). Females make up a significant percentage of the informal sector (Bizcommunity, 2014), thus, the African hair-care market will continue to grow. Research conducted by the Sustainable Livelihoods Foundation on the hair-care business in informal settings of Southern Africa has indicated that on average, the business of hair-care employs about 1.5 people per business and most of these employees are engaged on a permanent basis (Sustainable Livelihoods Foundation, 2012).

Factors such as decrease in formal employment, rapid development of the black population and the slow pace of economic growth are the main contributors to the current growth of South Africa's informal sector (Guliwe, 2013; Mchombu, 2000). Despite its economic contribution, especially job creation, investigation of the informal economy remains limited from a marketable viewpoint (Webb et al., 2013). This is because these businesses are not registered, the majority of informal business owners lack business skills and financial support, especially if one needs support in order to manage customers and day-to-day operations of the business (Guliwe, 2013; Anderson-Macdonald, Chandy, & Zia, 2014).

It is believed by several marketing scholars that in order for small businesses' performance to improve in emerging markets, improving their marketing skills is essential (Anderson-Macdonald et al., 2014). However, translating this belief into action seems to be a challenge. It is common, as mentioned by Anderson-Macdonald et al. (2014), especially in emerging markets for people to start businesses because of the shortage of employment opportunities in the formal sector. Therefore, as a result, these business owners engage in informal businesses as a way to survive as opposed to business expansion or growth (Ligthelm, 2013).

Research findings conducted by Anderson-Macdonald, et al. (2014) indicate that there has been formal evidence that shows that marketing skills can influence small business growth and prosperity, particularly in emerging markets. One major finding from an implemented marketing/sales training programme typically targeted to small business owners was that there were positive results in terms of the performance of these businesses (Anderson-Macdonald et al., 2014). Anderson-Macdonald et al.

(2014) mentions that on average, the changes in business performance after the marketing training skills included:

- 9.7% higher possibility of survival, which means there is a greater chance that the business will still be operational after 18 months
- 0.95 increase in employees (62% gain)
- Rand 9,350 increase in sales per month (69% gain)
- Rand 3,038 increase in profits per month (86% gain)

Therefore, the above statistics indicate that there is potential for growth in the informal hair-care business especially if marketing skills are intact, which will yield greater returns. However, the use of traditional marketing (TV, radio, magazines, newspapers) requires a huge spend and according to Lavinsky (2013), advertising through such medium (television, radio and billboards) is only a viable option for entrepreneurs or business owners that have a large marketing spend or budget. Since traditional marketing is not affordable, especially for businesses trading in the informal sector, due to financial constraints or lack of financial resources, the next resort for owners of such businesses would be to leverage on mobile marketing. This statement is justified by Etzo and Collender (2010) who assert that mobile phones are cost effective, convenient and the quickest form of communication. Moreover, an added value to the use for mobile marketing is that, in Africa, a large informal sector has also emerged to support the mobile industry, with informal entrepreneurs selling airtime, fixing and charging mobile devices (Etzo & Collender, 2010).

Tähtinen (2006) defines mobile marketing as a personalised and interactive wireless communication that provides customers or clients with location and time sensitive information that promotes ideas, product and services, thus benefiting all stakeholders. With a significant increase in the number of people using mobile devices globally, mobile technology denotes one of the fastest emerging marketing communication platforms (Rohm, Gao, Sultan & Pagani, 2012; Gao, Rohm, Sultan & Pagani, 2013). It allows consumers to access the internet, communicate and share information on their social networks and purchase online within the comfort of their lifestyles and daily routines (Rohm, Gao, Sultan & Pagani, 2012; Gao, Rohm, Sultan & Pagani, 2013). Mobile marketing has been getting a lot of attention in recent years (Chinomona & Sandada, 2013). Mobile activities have the potential to influence

consumer purchases as it enables companies to reach consumers anywhere and at any given time (Rohm et al., 2012).

According to the Mobile Marketing Association of South Africa (MMASA) (2015), the success of mobile marketing in emerging markets relies on understanding the African consumer and for the consumer to engage in it successfully, relevant strategies need to take place. These tactics include using tools that consumers are already familiar with in order to motivate participation (MMASA, 2015). A model by Lee, Moon, Kim, and Mun (2015) shows that interactivity has a positive influence on mobile phone usability, thus signifying that high levels of interactivity means that the user can control a device as preferred, while the device provides relevant personal information in a timely manner via multiple channels (Lee et al., 2015). Usability on the other hand denotes how easy it is to navigate, learn and understand a mobile phone (Lee et al., 2015). Therefore, this study aims to adapt this model in order to study the influence of mobile interactivity on mobile usability and mobile marketing acceptance within the South African context of the hair-care business in the informal sector.

1.3 Problem statement

Mobile marketing is increasingly being utilised in marketing globally. Marketers are increasingly viewing mobile phones as an attractive platform that allow them to interact with consumers, using different forms of marketing communication (Mimosette & Djumene, 2015).

Given the nature of the informal sector, there are still many knowledge gaps relating to the ways in which to support the informal economy in order to stimulate sustainability and economic growth (Charman & Petersen, 2014). One of the ways to stimulate the growth of these businesses is to equip entrepreneurs with marketing skills, which is an essential tool that one needs in order to manage profitable customer relationships (Cooney, 2012).

Therefore, since traditional marketing is costly and requires a large budget (Lavinsky, 2013), and is not suitable for the small businesses trading in the informal economy, mobile marketing can play a key role. A report from the Mobile Marketing Association (2015) indicates that marketing practitioners are seeing mobile marketing as a platform

to make product and service offerings more affordable and pertinent to low income consumers, and as a retention strategy. Thus, understanding the driving factors that influence mobile marketing acceptance of the informal hair-care business operators in South Africa provides a justification for this study.

1.3.1 *Main problem*

The main problem is the limited academic and empirical knowledge on perceived mobile interactivity influence on usability and mobile marketing acceptance in the informal hair-care business, particularly in South Africa.

1.3.2 *Sub-problems*

The first sub-problem is to investigate how the dimensions of interactivity, namely, control, responsiveness, nonverbal information and personalisation influence the usability of a mobile phone within the informal hair-care business sector.

The second sub-problem is to examine the influence of perceived mobile phone usability on mobile marketing acceptance within the informal hair-care business context.

1.4 **Research objectives**

This research seeks to address the theoretical and empirical objectives outlined below.

1.4.1 *Theoretical objectives*

This study reviews the following theoretical objectives:

- To review literature and theory on perceived control
- To review literature and theory on perceived responsiveness
- To review literature and theory on nonverbal information
- To review literature and theory on perceived personalisation
- To review literature and theory on mobile phone usability
- To review literature and theory on mobile marketing acceptance

1.4.2 ***Empirical objectives***

This study addresses the following empirical objectives:

- To investigate the influence of perceived responsiveness on mobile phone usability
- To investigate the influence of nonverbal information on mobile phone usability
- To investigate the influence of perceived personalisation on mobile phone usability
- To investigate the influence of mobile phone usability on mobile marketing acceptance

1.5 **Research questions**

This study addresses the following research questions:

- To what extent does perceived control influence mobile phone usability?
- To what extent does perceived responsiveness influence mobile phone usability?
- To what extent does nonverbal information influence mobile phone usability?
- To what extent does perceived personalisation influence mobile phone usability?
- To what extent does mobile phone usability influence mobile marketing acceptance?

1.6 **Justification of the study**

There has been a significant amount of research that has been conducted on the informal sector over the past decades (Charman & Petersen, 2014), especially focusing on those entrepreneurs that engage in informal businesses driven by seeking self-realisation and those that are motivated by economic needs (Williams & Nadin, 2010). However, there has been little research done on the influence of marketing activities in general in the informal sector businesses.

Furthermore, there has also been a growing amount of research examining the influence of mobile marketing acceptance amongst consumers, but with specific focus on the youth (Gao et al., 2013). However, there has been little research conducted on mobile marketing acceptance especially from a firm's point of view, particularly in the informal sector. Previous studies have focused on mobile marketing from a consumer's viewpoint; however, studies on mobile marketing acceptance from a small business's point of view, especially studies that focus on the mobile marketing acceptance by hair-care businesses in the informal sector are relatively few, if any, in South Africa.

Thus, the main justification for this research is that these hair-care business operators are entrepreneurs who can use mobile marketing to reach out to many clients as a retention strategy by offering them customised service offers, yet there are few known studies in this area. It is not known whether these entrepreneurs have accepted using mobile marketing as a marketing tool and if they have, little is also known in terms of its impact as a marketing platform to enrich their businesses. Again, if they have accepted using mobile marketing, what influences these entrepreneurs to accept or prefer this approach? Could it be because of the usability or interactivity of the mobile device? This indicates that there is still a gap in literature about the mobile marketing acceptance and its influence in the small business sector.

1.7 Significance of the study

From a theoretical viewpoint, this research contributes to marketing literature, since there is limited research conducted on mobile marketing acceptance in small informal businesses, specifically, in hair-care services in South Africa. This study contributes to current literature by generating new literature for researchers and scholars in marketing and business management. The aim is bridge the gap given that there is little evidence in literature that addresses what this study aims to research. Research findings and recommendations are also highlighted for future research suggestions.

From an empirical viewpoint, it was anticipated that the outcome of this research would be of benefit to policy makers as it aimed to offer formal evidence that mobile marketing can influence the prosperity, survival and growth of small informal businesses. This study also anticipates that policy makers would adopt and implement

mobile marketing as a training programme aligned with their core strategies that are in place to increase growth and sustainability for small informal businesses. This would add value to the advancement of entrepreneurship in Small, Medium and Micro-sized Enterprises (SMMEs) that has been prioritised by the South African government because it acts as a catalyst in achieving economic growth and development (Ligthelm, 2008). The mobile marketing initiatives will also serve as assurance that policy makers have allocated adequate resources in order to stimulate growth and sustainability of small businesses.

It was also anticipated that the findings and outcome of this study will add value to the field of marketing within South Africa's mobile communications companies. Mobile marketing involves using the device to interact with customers, meaning that large amounts of data and airtime are purchased. Mobile communications companies can leverage on this by offering bulk discounts of airtime and data bundles to these hair-care businesses in the informal sector or even a free trial internet usage to encourage user interaction with the mobile device. Moreover, mobile phone manufactures will also benefit from this study as it provides guidance concerning mobile phone functionality and factors that influence mobile phone interactivity. Users perceive usability of a mobile phone based on its interactivity; therefore, these users are likely to purchase mobile phones that provide a simplified interface.

Other industries that this study hopes to benefit are the companies that are leaders in the local African hair-care space, such companies include Unilever (Sunsilk and Motions), L'Oréal (Dark and Lovely) and Sofn'free. The use of mobile marketing will enable hair-care businesses to reach out to a large client base whilst creating sustainable customer relationships, thus yielding customer satisfaction and profitability and yet creating even more demand for hair-care product supplies.

1.8 Delimitations of the study

The primary focus of the study was on the hair-care business on the informal economy, specifically hair-care businesses that operate in the townships and central business districts around the Johannesburg area.

Other activities practiced in the informal sector such as those known to be operating 'underground', i.e. drug dealing, human trafficking, and other illegal merchandises (Williams, 2007) that are meant to be harmful and not contribute positively into the mainstream economy were excluded from this study.

1.9 Definition of terms

- ***Informal Sector***

Informal economy is defined as a sector that operates unregistered yet legal but not regulated businesses that do not involve any criminal activities; this sector involves those people that are employers or self-employed who are not complying with tax regulations and other standard businesses practices (Williams, 2007). It is worth noting that for the purpose of this study, informal sector, informal economy and small informal businesses or activities are used interchangeably.

- ***Mobile Marketing***

Mobile marketing is defined as a personal and interactive form of communication that enables dialogue-orientated communication between the marketer and the consumer (Tähtinen, 2006).

- ***Interactivity***

The condition experienced by an individual through an interaction or communication with a mobile device (Lee et al., 2015).

- ***Perceived control***

Perceived control is the supposed ease of executing the target behaviour, reflective of, not only the user's past experience, but also anticipated obstructions and impediments (Lee et al., 2015)

- ***Perceived responsiveness***

Captures how a system responds to user input appropriately and in a timely manner (Lee et al., 2015).

- ***Nonverbal information***

Nonverbal information is the degree to which communication is perceived to be achieved using multiple channels (Lee et al., 2015).

- ***Perceived personalisation***

Perceived personalisation denotes the degree to which the responses of a communicative information system are perceived to be suitable or personally relevant to the user's communicative behaviour (Lee et al., 2015).

- ***Usability***

Refers to the user's ability to learn, understand and navigate a mobile device (Lee et al., 2015).

1.10 Assumptions

- Respondents responded to questionnaire with integrity and honesty
- Respondents made time to respond to the questionnaire
- Respondents could read English
- Respondents knew and understood the interface of their mobile phones
- All respondents had smart phones

CHAPTER 2. LITERATURE REVIEW

2.1 Introduction

This section provides a detailed discussion on early and recent literature on aspects relating to the dimensions of perceived interactivity, i.e. perceived control, perceived responsiveness, nonverbal information and perceived personalisation and how these factors influence mobile phone usability, which is the antecedent of mobile marketing acceptance as proposed by the study model. The discussion first outlines the theoretical evidence, which is the theoretical grounding that was utilised to contextualise the study. In view of the aforementioned, a discussion of the Theory of Technology Acceptance Model (TAM) and the Theory of Planned Behaviour (TPB) is conducted, followed by a discussion of the study constructs and then the presentation of the conceptual framework and hypothesis development.

2.2 Theoretical grounding

This study has adopted the Technology Acceptance Model (TAM) and Theory of Planned Behaviour (TPB) (Lu, Zhou & Wang, 2009) in order to explain the nature of interactivity influence on usability and mobile marketing acceptance.

2.2.1 *The theory of planned behaviour (TPB)*

The investigation into the theory of planned behaviour (TPB) has been performed across different contexts, behaviours and populations (Hsieh, 2015). A number of theoretical models and frameworks have been presented and verified by several scholars (Oliveira, Cherubini & Oliver, 2013) explaining user acceptance behaviour using the TPB. According to Oliveira, et al. (2013), although these theoretical models have contributed in understanding user preferences and acceptance or adoption behaviour of technological objects, they lack explaining the user experience concerning technology. It was therefore, for the purpose of this study to use TPB to investigate user mobile phone interactivity intention with respect to perceived mobile phone usability, thus user acceptance or adoption of mobile marketing.

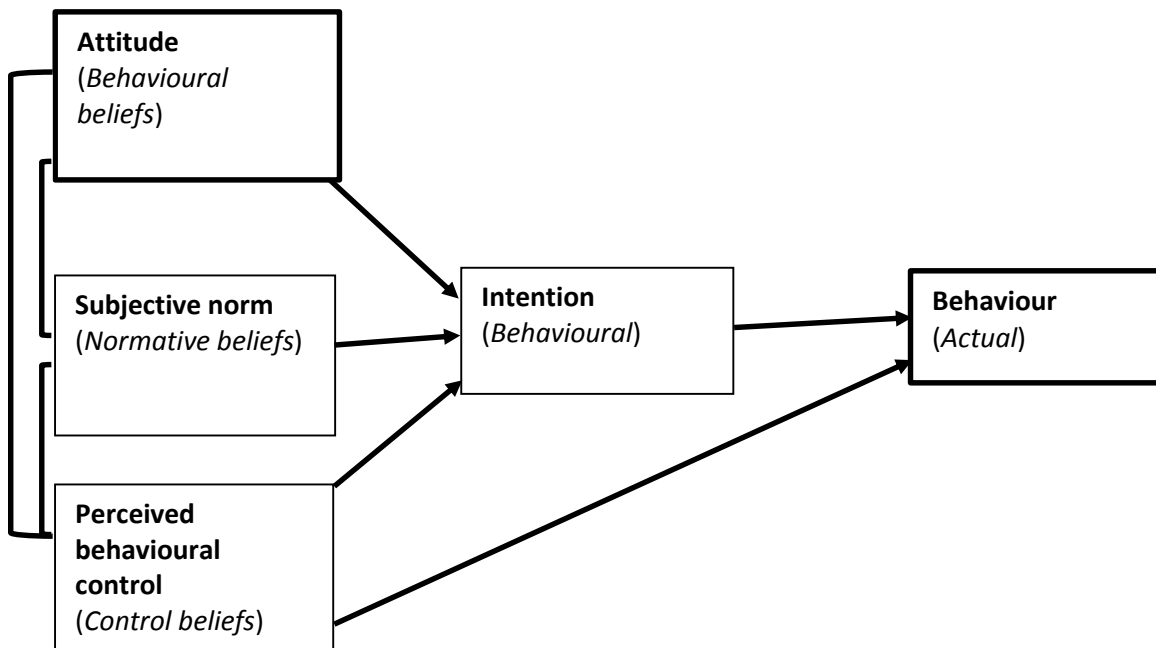

Figure 1: Theory of Planned Behaviour

TPB comprises three independent determinants utilised to forecast the intention of use, and ultimately behaviour (Oliveira, et al., 2013). These three key instruments contain attitude, behavioural control subjective norms (Ajzen, 1991). The theory highlights that attitude, perceived behavioural control and subjective norm affect behavioural intention, thus resulting in the actual behaviour (Lu et al., 2009). Attitude towards the behaviour denotes the degree to which a user has an optimistic or pessimistic evaluation of the behaviour in scrutiny (Ajzen, 1991). Subjective norm is a second predictor that is a social factor and denotes the apparent social pressure to execute or not to execute the behaviour (Ajzen, 1991). Perceived behavioural control as the third antecedent of intention describes the perceived ease of use or struggle in the execution of the behaviour and it is presumed to reflect past experiences as well as foreseen obstacles (Ajzen, 1991).

According to Ajzen (1991), the general rule is that the more favourable the subjective norm and attitude are with respect to the behaviour, the greater the perceived behavioural control, and the stronger should be the user's intention to execute the behaviour under scrutiny (Ajzen, 1991). The comparative significance of perceived behavioural control, subjective norm and attitude in the prediction of intention is

anticipated to differ across behaviours and circumstances (Ajzen, 1991). Therefore, in some applications, it can be seen that attitudes have a significant influence on intentions, in others that perceived behavioural control and attitudes are satisfactory to account for intentions, and in others that all three variables make independent contributions (Ajzen, 1991).

This study has therefore adopted TPB to predict and understand user's intentions to engage in mobile phone activities and interaction. Intention to use may perhaps offer mobile phone or device practitioners some valued insights on the determining factors that influence effective mobile phone interactive engagement. In line with Oliveira et al. (2013), intention assists in understanding the user's judgment based on how they make their ultimate decision to engage or interact with the mobile phone or device. Therefore, a positive intention can lead the user to want to interact with the mobile phone in order to improve his or her communication efficiently.

Therefore, it can be argued that when users form a positive attitude towards the interactivity of their mobile phones, they are more likely to perceive usability and have a stronger intention towards adopting and accepting mobile marketing. In justification, Ajzen and Fishbein, (2008) suggest that attitude towards a particular activity or action results in a greater intention to carry out that behaviour.

2.2.2 *The Technology Acceptance Model (TAM)*

The Technology Acceptance Model (TAM) has been theoretically (Cheng, Chen & Yen, 2015; Davis, 1989; Ko, Kim, & Lee, 2009; Sánchez-Prieto Olmos-Migueláñez & García-Peñalvo, 2016) applied in numerous arenas to study an extensive range of information technologies. TAM, primarily based on the theory of reasoned action (TRA) has been adapted to model users' adoption and acceptance of information systems (Lu et al., 2009). Therefore, the model as initially proposed by Davis (1989) provides a base to understand the user's usage, adoption and acceptance of technologies.

This model argues that external variables, namely, perceived ease of use and perceived usefulness have an impact on usage attitude and usage intention which

results in actual usage (Lu et al., 2009; Bakar & Bidin, 2014). Moreover, according to Lu et al. (2009), the most important concepts of the technology acceptance model are perceived ease of use and perceived usefulness. Perceived ease of use denotes the user's perceived efforts when using the technology and perceived usefulness is concerned with the user's feelings of better performance when using technology (Lu et al., 2009).

Marketing scholars and practitioners have focused predominantly on features of mobile commerce to forecast the likelihood of technology adoption and acceptance (Kim, Chan, & Gupta, 2007; Kleijnen, Ruyter & Wetzels, 2007; Lee & Park, 2006; Wu & Wang, 2005). Generally, unique mobile commerce features have included personalisation, suitability and instant connectivity (Kim et al., 2007; Lee & Park, 2006). This implies that in order for users to adopt mobile marketing they need to find a mobile phone as a useful tool in improving their communications efficiently, which is the level of interactivity in terms of ease of use and usefulness, while enabling them to be able to chat with others conveniently (Lu et al., 2009). Mobile phone characteristics such as ease of use and usefulness play a crucial role in forming a positive attitude towards using technology, and hence technology acceptance (Bruner & Kumar, 2005; Kulviwat, Bruner, Gordon, Kumar, Nasco, & Clark, 2007).

TAM suggests that perceived ease of use and perceived usefulness are the two significant influences that determine the adoption of any technology (Shankar, Venkatesh, Hofacker, & Naik, 2010). Several enablers fall under this category, the first key enabler is networking; mobile phones allow people to interact and keep in touch with family, friends, customers and social networks (Shankar et al., 2010), thus increasing the perceived usefulness of the mobile device. This therefore, makes it vital for businesses to design and customise their offerings to suit these segments based on the variance on the user's purpose of the primary usage (Shankar et al., 2010).

The second enabler is the range of the applications of the mobile device, which increases usefulness and consequently enhances acceptance (Shankar et al., 2010). The ease of use of the mobile phone and its applications, therefore, greatly increases acceptance and adoption. For example, services provided by a mobile device, such as connection stability, convenience, enjoyment, ease of use, technicality and

usefulness lead to the user's acceptance of mobile commerce (Kim, Chan, & Gupta, 2007; Park, 2006).

Although TAM has been assessed and believed to be effective in examining technology adoption and acceptance for individuals (Dahnil, Marzuki, Langgat & Fabeil, 2014), TAM is also suitable to investigate technology acceptance by businesses or organisations such as small to medium businesses. Scholars, Yu & Tao (2009), clarify that since a business or an organisation includes a group of people or individuals, it means that a business behaviour is a collective behaviour of individuals. Therefore, to incorporate TAM in a business or organisational environment, the perceived usefulness can be defined as the number of benefits obtained by the organisation by means of the new technology, which is subjectively assessed by key decision makers in the organisation (Dahnil et al., 2014).

Similarly, perceived ease of use is defined as the extent to which a business can effortlessly utilise the new technology (Dahnil et al., 2014). In this context, effort, refers to technology switching barriers, monetary investment, maintenance costs and employee training time (Dahnil et al., 2014), whereby the decision-making process by the business manager or owner is identical to the decision making process of an individual. Signifying that, the technology acceptance or adoption by the business itself depicts similar behaviour of an individual (Dahnil et al., 2014).

2.3 Perceived Interactivity

Perceived interactivity has been defined in numerous methods in literature (McMillan and Hwang 2002; Rafaeli & Sudweeks, 1997; Suki, 2011; Sundar & Kim, 2005). However, most scholars highlight the importance of interaction and communication amongst the user and the system. Studies conducted by Mazursky and Vinitzky, (2005) on the dynamics of the online purchasing procedure propose that customers demonstrate diverse search patterns derived from the distinct attribute of the interface, which is faster, however distinct from the search pattern features of purchasing in a traditional store. Before identifying the elements of perceived interactivity, it is imperative to evaluate and inspect the concept of interactivity and how it is assessed.

According to Chu and Yuan (2013), scholars (Newhagen, Corders & Levy, 1995) were the first to advocate the theory of perceived interactivity, observing interactivity as a psychological construct in a content examination of e-mail messages of spectators (Song & Zinkhan, 2008). Perceived interactivity has been extensively defined in several disciplines, and is regarded as fundamental to effective website marketing (Johnson, Marakas & Palmer, 2006; Kim, 2011; Lee, 2005; Suntornpithug and Khamalah, 2010; Umar, 2012). A website that permits its users to pursue and gain access to information on request, and provides content under their own control, is perceived to have better interactivity with customers (Chu & Yuan, 2013).

Interactivity has been researched by several scholars (Chu & Yuan, 2013; Kim, 2011; Teo, Oh, Liu, & Wei, 2003; Wu & Wu, 2006; Yoo, Kim & Sanders, 2015; Umar, 2012), as an important feature of websites that motivates users' online activities and attitudes. Interactivity involves a sense of satisfaction, fun; following performance quality and better user engagement experience (Teo et al., 2003). In the present day, mobile phones or devices provide various functionalities, together with feedback messages, different responses, navigational signals and directions when a user tries to access these different functionalities (Lee et al., 2015). Chu and Yuan (2013) indicate that, based on a functional approach, perceived interactivity is associated with customisation, which means that users receive their own combination of tailored online communication and experiences.

Lee et al. (2015) define interactivity as the state experienced by users throughout their interaction and communication with a mobile phone. Wu and Wu (2006) posit that the users determine the extent of the actual interactivity since it is up to the users to realise and understand the potential competence provided by actual interactivity. Henceforth, perceived interactivity plays a significant role in understanding the actual interaction potential of the users (Lee et al, 2015). However, very little notable research has studied perceived interactivity empirically in the context of the use of the mobile phone (Lee et al, 2015). Perceived interactivity has been theorised as a multidimensional concept in prior studies (Ha & James, 1998; Heeter, 2000; Oblak, 2005; Zamith, 2008).

Scholars (Dholakia, Zhao, Dholakia & Fortin, 2001; Florenthal & Shoham, 2010; Wu, 2005) propose that the key dimensions of interactivity are personalisation, user

control, connectedness and responsiveness. Wu and Wu (2006) hypothesise perceived interactivity as composed of three components, namely, perceived personalization, perceived responsiveness, and perceived control. Johnson, Bruner and Kumar (2006) state that nonverbal information, speed of response and responsiveness significantly relate to perceived interactivity. Scholars (Song & Zinkhan, 2008) assess perceived interactivity on three elements namely, control, responsiveness and communication. Therefore, synthesising the outcomes of these studies, this research hypothesises interactivity as a second order concept consisting of perceived control, perceived responsiveness, nonverbal information, and perceived personalisation (Lee et al., 2015). Prior studies (Johnson et al., 2006; Song & Zinkhan, 2008) conceptualised these sub-constructs to be effects of perceived interactivity. Following the theorisation presented by prior research on interactivity, this study hypothesises the effect of these sub-constructs on usability.

2.3.1 *Perceived control*

Perceived control has been identified as a crucial construct in mediating an individual's behavioural and emotional response to a physical setting. It is a human driving force and has been demarcated as the need to demonstrate and prove one's superiority, mastery and competence over the environment (Hui & Bateson, 1991). Several scholars (Liu & Shrum, 2002; Voorveld, Neijens, & Smit, 2011) have defined control as an instrumental and voluntary action that influences the user's experience directly. Control also refers to the degree that a controller can choose the sequence, timing and content of a communication system (Lee, 2005; Dholakia, Zhao, Dholakia & Fortin, 2000).

Control is an element of interactivity, and it is referred to by Liu and Shrum (2002) as active control, however, other scholars (McMillan & Hwang, 2002) refer to this element as user control, which is the individual's ability to voluntarily partake in and instrumentally stimulate a communication (Liu, 2003). Navigational tools such as search options, hyperlinks and sitemaps or the capability to customise information on a search engine facilitate control (McMillan, 2000; Song & Zinkhan, 2008). A number of scholars have excluded control as a central measurement of interactivity, arguing

that control is only essential to facilitated forms of interactivity (Johnson, Bruner & Kumar, 2006).

Previous studies (Green & Baston, 2003) done on control do not conceptualise the concept in the same way, and it has been found that the word control is frequently used to refer to external control, which is defined as having control over what has been done to one and is often associated with involvement in decision-making. In this context, it may also refer to internal control, which is control over one's body and behaviour and this type of control is denoted to be perceived behavioural control (Lee et al., 2015). According to Lunardo and Mbengue (2009), perceived control has been recognised as a powerful concept for understanding one's behaviour over the past decades.

Lee, Moon, Kim and Mun (2015) define perceived control as the perceived ease of performing the target behaviour that reflects the perceiver's past experiences and obstacles. This indicates the need to show one's ability, control and dominance over the environment (Noone, 2008; Lunardo, & Mbengue, 2009). Research on environmental psychology has found that people who perceive they are more in control over the environment tend to behave or participate more actively and positively (Lee et al., 2015; Lee, 2005). As such, there has been significant evidence demonstrating how increased perceived control has a positive influence on one's psychological and physiological well-being (Noone, 2008).

The sensation of being in control or controllability has been measured as a desirable psychological state. Being in control has been found to lead to increased self-efficacy beliefs (one's belief in own ability to complete a task or reach targeted goals) (Tafarodi, Milne & Smith 1999; Gist & Mitchell 1992), increased satisfaction (Judge, Bono & Locke 2000) and less stress (Amirkhan, 1998). However, it is emphasised that lack of control produces low levels of perceived competency (Judge, Bono & Locke 2000; Amirkhan 1998). According to Liu and Shrum (2002), by giving a user, the power to control their online purchases or experiences, user interactivity and satisfaction becomes greater, thus enhancing the user's self-efficacy beliefs. Moreover, in a study conducted on online purchases and processes it was found that consumers who perceive that they have more control over the purchase process in an online

environment tend to have high levels of trust (Chu & Yuan, 2013; Wang, Meng & Wang, 2013).

Additionally, it has been found by Noone (2008) that the concept of perceived control is an important factor of interpersonal interaction. Noone (2008) proposes that interpersonal needs are driven by human social behaviours, suggesting that in order for satisfactory interactions with other individuals, the feeling of being in control is vital. Moreover, in accordance with the statement, Lunardo and Mbengue (2009) state that the perception of control is positively associated to positive reactions, such as fulfilment and pleasure. Rose, Clark, Samouel and Hair (2012) reiterate by uttering that when a user feels in control over a device, it decreases the perception of effort and increases the level of confidence and enjoyment over it (Cheung, Lee, & Chan, 2015).

Moreover, Rose, Clark, Samouel and Hair (2012) propose that perceived control has an impact on ease of use (such as search, functionality and navigation); connectedness (the capability to connect, share ideas and knowledge with others in a social network); and customisation (such as being able to personally modify a website's appearance and its functionality) (Martin, Mortimer & Andrews, 2015). For instance, in a case of an object, individuals become confident interacting with that particular object when they understand how it works or how to operate it (Lee et al., 2015). Thus, control seems to be a major concept for users to enjoy their experience (Lunardo & Mbengue, 2009), which is crucial when it comes to interacting with a mobile device (Lee et al., 2015).

2.3.2 ***Perceived responsiveness***

Several scholars (Shin, Jung & Chang, 2012; Johnson et al., 2006; Wu, 2000; Lee, 2005; Manganari, Siomkos, Rigopoulou, & Vrechopoulos, 2011; Kim, 2011), have proposed that responsiveness is a facet or dimension of perceived interactivity. The concept of perceived responsiveness has been explored by quite a number of scholars (Reis, Clark, & Holmes, 2004; Lemay, Clark & Feeney, 2007) on how it influences social support or relationships.

In social support theories, it was found that Individuals perceive responsiveness when their partners validate, understand and show them that they care (Reis et al., 2004). On the other hand, studies conducted on relationship theories have indicated that perceived responsiveness plays a huge role and is a central facet of satisfying a relationship (Lemay et al., 2007). Accordingly, it is predicted by Maisel and Gable (2009) that if social support is intended to be high in responsiveness, then distress should be relieved, however, if the support is low in responsiveness, then distress will not be relieved.

Other research on this construct focuses on how responsiveness influences trust in systems (Wang et al., 2013). Therefore, the discussion on this concept will be contextualised in the communication sphere with primary focus on responsiveness in terms of the response speed or time, with the response speed referring to the amount of time a response to earlier communication takes, which is perceived to be without delay or immediate (Voorveld et al., 2011; Dholakia et al., 2000).

Responsiveness has been defined as the degree to which a response in a communication system is perceived to be relevant and appropriate to the user's query at a given time (Burgoon, Bonito, Bengtsson, Ramirez, Dunbar & Miczo, 1999; Johnson et al., 2006; Yoo, Kim & Sanders, 2015; Lee et al., 2015). For example, in a case of electronic word of mouth (e-WOM) when information on company websites lacks relevance, simplicity and is repetitive, then the response for e-WOM becomes low and low responsiveness leads to low user satisfaction (Yoo, Kim & Sanders, 2015). Thus, the communication system has to respond to user's information needs, representing the ability to address the user's earlier messages in order to carry out a dialogue or conversation with that user, consequently, responsiveness focuses and places emphasis on the response from the communicator rather than the user (Dholakia et al., 2000; Chu & Yuan, 2013).

Perceived responsiveness is associated to timeliness of information and prior studies conducted by Lee (2005) indicate that for the perception of interactivity to be greater, the response has to be fast, thus indicating that the extent of responsiveness in a system strongly influences the formation of trust in mobile commerce (Wang et al., 2013). Instant messaging, for example, is an attempt to increase perceived interactivity of a website over forwarded email and a traditional store (Dholakia et al., 2000).

Van Riel, Lemmink, Streukens and Liljander, 2004 have identified this dimension in the case of supporting online services, that is, it is anticipated to contribute directly to overall satisfaction of the user service encounter. Perceived responsiveness is associated with the ability to respond speedily to demands for support (Van Riel et al., 2004). In this case, the speed in which the mobile commerce reacts offers assistance to difficulties experienced by users and seems as an important service quality (Van Riel et al., 2004). Therefore, the interaction in diverse forms is at the heart of all service encounters and is an essential component of online services (Grönroos, Heinonen, Isoniemi & Lindholm, 2000).

In the context of an online environment, the concept of responsiveness consists of four constituents, namely, response relevance, response probability, response elaboration and response speed (Wu 2000; Lee, 2005). In a study conducted by Yun (2007) on the influence of response time on perceived interactivity, it was found that when a website responded faster, the interactivity was perceived to be greater. Manganari et al. (2011) propose that users who perceive to have more responsiveness of the purchase process in an online environment tend to perceive high levels of interactivity.

Moreover, when a user is making a purchase online, responsiveness is measured by how willing and ready the system is to respond and attend to customer needs when they experience a problem and how soon the enquiry can be answered (Nadeem, Andreini, Salo, & Laukkanen, 2015). Lee et al. (2015) add by stating that an instant response is a crucial aspect in interactive communication, implying that users enjoy and respond very well to the interaction process when a system or device provides appropriate responses instantly (Yoo et al., 2015).

2.3.3 ***Nonverbal information***

According to Buck and VanLear (2002), there has been a significant research interest in the role of nonverbal behaviour in communication in recent years. Nonverbal information is defined as the degree to which multiple channels are utilised for communication purposes (Johnson et al., 2006; Lee et al., 2015; Yoo et al., 2015; Burgoon et al., 1999). Lee et al. (2015) accentuate that individuals tend to use more than one single channel when it comes to communicating information. For instance, it

has been found by Johnson et al. (2006) that the use of facial expressions, gestures, pace of speech, tone of voice, loudness and voice quality (known as nonverbal elements) enrich a dialogue and give it meaning (Song, Hollenbeck & Zinkhan, 2015).

Researchers (Tossell, Kortum, Shepard, Barg-Walkow, Rahmati & Zhong, 2012) have noted the significance of using nonverbal signals to understand the nature and meaning of a communication or message. For instance, studies by Derks, Fischer and Bos (2008) present that emoticons can offer this information and improve computer-mediated communication. Emoticons are defined as graphic symbols of facial expressions that are entrenched in electronic messages (Tossell et al., 2012). These frequently include letters to make expressions such as, sad, frustrated or happy and punctuation marks respectively (Tossell et al., 2012). Scholars (Derks et al., 2008) have recommended that these signs enrich written communication and messaging in the same way body or visual language supports verbal communication.

Studies on advertising research considers psychological imagery to be a key issue in mobile advertising (Gavilan, Avello & Abril, 2014). Gavilan et al. (2014) define mental imagery as a process whereby nonverbal information is representing working memory, encompasses three elements, elaboration, quantity and vividness. The role of mental imagery stimulated by advertising has been researched extensively in traditional media (Rodero, 2010). Past research has shown that psychological imagery stimulates an array of reasoning and affective responses or reactions to the advertising message, which includes attitude towards the advertisement, attitude towards the brand and advertisement recall (Babin & Burns, 1997). Additionally, for consumers that like to shop using the web, psychological imagery increases their intentions to purchase or revisit the website (Argyriou, 2012) and enhances optimistic feelings (Lee & Cheng, 2009).

According to Li and Yeh (2010), a website design's visual aesthetics are found to be essential for attaining trust from consumers (Karvonen, 2000). The elements of design aesthetics comprise photographs, colour, layout and font (Li & Yeh, 2010). Moreover, Lee et al. (2015) state that nonverbal elements such as pictures, type and size of letters, punctuation, audio, use of video and the use of boldface are utilised a lot in

print communications in order to influence interactivity. Recent research has shown that nonverbal elements, i.e. pictures, are easier to recall than words (Gavilan et al., 2014). Prior research by Johnson et al. (2006), has found that the interactivity of communication channels is stimulated by the richness of nonverbal elements, the use of video clips or images. These elements add richness to already established text, thus resulting in better information (Yoo et al., 2015). Therefore, nonverbal elements, such as bandwidth size, is one of the imperative features of technology utilised for communication drive (Lee et al, 2015).

2.3.4 ***Perceived personalization***

According to Guo, Sun, Yan and Wang (2012), the negative significance of personalisation has seldom been investigated. As a result, there is a need to assess, develop and improve a comprehensive and understandable view of the success of personalisation.

Personalisation has been acknowledged, and executed by many authors (Pierrakos, Paliouras, Papatheodorou, & Spyropoulos, 2003; Murthi & Sarkar, 2003; Vesanen & Raulas, 2006). According to Fan and Poole (2006), at a theoretical level, personalisation means diverse things to different individuals in different fields. For instance, for social scientists it is a way of improving social relations and constructing social networks; for architects, personalisation means making pleasant individual spaces that are functional (Cummings, Butler, & Kraut, 2002; Wellman, 2002). However, for computer scientists, personalisation is perceived as a toolbox of technologies to enrich the website experience through the user interface design (Fan & Poole, 2006). Therefore, for the purpose of this study, this definition applies.

Presently, mobile information and communication services are providing more than users perceive they need (Asif & Krogstie, 2013). According to Asif and Krogstie (2013) the one-size-fits-all approach appears not to be effective, particularly for mobile services, instead, this method may cause displeasure for the users. Conversely, some characteristics of personalisation can cause complications and may overshadow the benefits of personalisation (Asif & Krogstie 2013). Therefore, there is a need to evaluate the effectiveness and usefulness of personalisation of mobile services (Asif

& Krogstie 2013). Personalisation can play an important role in providing user personalised services (Asif & Krogstie 2013). Personalisation, also referred to as customisation, reflects the extent to which information is custom-made to meet the needs of the user (Fan & Poole, 2006).

As different from user responsiveness and control, personalisation is integrated in the system's ability to use information that is provided by the user to offer a customised web experience (Fan & Poole, 2006). Although an automated email reply function may increase the perception of responsiveness, it does not increase the perception of personalisation (Dholakia et al., 2000). In mobile and electronic commerce, perceived personalisation has been documented as an essential approach component in consumer relations and website strategies (Fan & Poole, 2006). However, there are extensive variances in how this perception is characterised, defined and implemented in literature (Fan & Poole, 2006).

Perceived personalisation also refers to the degree to which a response of a communicative information system represents and understands the user's personal needs (Komiak & Benbasat, 2006; Song, Hollenbeck & Zinkhan, 2015; Taylor & Davis, 2015). Thus, indicating that the perceived system needs to be personally relevant and appropriate according to the communicative behavior of the user (Lee et al., 2015; O'Donnell & Cramer, 2015; Ho, Chen, & Luo, 2015).

Moreover, Song and Zinkhan (2008) state that there is a linear relationship between the level of personalisation of a website message and interactivity perceptions. Web personalisation refers to the process of adjusting web content to meet the specific needs of users by delivering the right content to the right user at the right time while maximising business opportunities (Tam & Ho, 2006). Therefore, in the context of a mobile device utilisation, perceived personalisation in terms of both personal and message relevance shows how technology treats the user throughout the interaction process (Lee et al., 2015; Cheung, Lee & Chan, 2015).

Furthermore, personalisation is not intended to take control away from the user, but puts the user in control while utilising a service or mobile device (Asif & Krogstie, 2013). When users feel to be more in control over the data and adaptation process,

they are more likely to trust which will therefore result in user satisfaction (Asif & Krogstie, 2013). As described by Mesquita, Barbosa and de Lucena (2002), users are responsible for the initiation of the adaptation procedure and they must have control over it because users may be eager to control modifiability, adaptability and re-configurability of the personalisation process.

In a survey conducted by scholars (Perugini & Gonçalves, 2002), suggested that in order to achieve the right balance between personalisation and privacy, users have to be in control. The trust of the user will increase if services or mobile devices allow them to be in control over their information (Asif & Krogstie, 2013). Furthermore, transaction between the risks and benefits of personalisation must be explicit depending on the user's involvement level (Frank & Harnisch, 2014). In a study conducted by Recker (2009), it was noted that for users to accept personalisation of systems, the users need to feel like they are in control.

2.4 Mobile phone usability

According to Lee et al. (2015), usability has been a key theme in human–computer interaction studies. Whereas there is no strong agreement on the meaning of usability, it has been generally related with the perception of the ease of utilising a target object (Lee et al., 2015). Barnard, Bradley, Hodgson and Lloyd (2013) state that usability is associated with qualities of the product that make it learnable, understandable, attractive and easy to use. In addition, the IEEE Standard Computer Dictionary describes usability as the ease of the user to learn, prepare inputs and understand outputs (Lee et al., 2015). Barnard et al. (2013) emphasise this by defining usability in relation to user experience, and denotes that usability is associated with intrinsic characteristics of the device or system in relation to the attitude, perceptions, skills and abilities of the user.

In an article by Coursaris and Kim (2006), it was mentioned that usability has been a focus of discussion for a very long time, both in academia and relevant industries. However, although there is a considerable volume of research on usability in general, there has been little research conducted on mobile usability, bearing in mind the novelty of mobile technology (Coursaris & Kim, 2006).

Van Riel et al. (2004) state that usability is also a dimension of e-service quality and propose that the user interface is therefore crucial in this case. This refers to all functional features of online services; the first one is the user accessibility of the website (Cox, & Dale, 2001). Secondly, ease of navigation, which refers to the amount of effort that the users need in order to find what they are looking for in the website (Van Riel et al., 2004). Thirdly, website reliability, which refers to precise technical functionality and accuracy, signifying that consistent, relevant and reliable interactions with a website increase internet usage (Van Riel et al., 2004). Lastly, efficiency, which has a strong impact on usability as it reflects the ease of use of the website.

Lee et al. (2015) define usability as a perception that evaluates how easy it is to learn, use, and understand a device (Nayebi, Desharnais & Abran, 2012). Moreover, Coursaris and Kim (2006) substantiate by stating that the central theme of usability is to signify the ease, which users of a particular technology device can employ in order to accomplish a particular objective. For instance, in a website, usability denotes the perceived ease of being able to navigate the website or being able to make an online purchase (Flavián, Guinalíu & Gurrea, 2006).

According to Venkatesh, Ramesh and Massey (2003), in a study conducted on mobile internet usability, it was discovered that usability was the biggest source of frustration as pointed out by users surveyed. As a result, perceived behavioural control has been found to influence the ease of use perception significantly (Mun, Jackson, Park & Probst, 2006). Furthermore, studies have found that user interface features, for example, content design and page layout are key determining factors for successful user interaction within an online store setup (Venkatesh et al., 2003), which speaks back to the use of nonverbal elements as a communication channel to stimulate user interactivity. Manganari et al. (2011) and Castaneda et al. (2009) elaborate more by stating that perceived ease of use confidently impacts on the individuals' attitude toward utilising a website, which in turn stimulates the future use of it.

Concisely, usability as specified by Flavián et al. (2006) reflects the following factors:

- The ease of use in understating the structure, contents, interface, and functionality of a system observed by the user

- The ability of the user to be able to control where they are and what they are doing at any given moment
- The speed or amount of time the users spend trying to find items that they are looking for, followed by response speed

Therefore, it can be concluded that ease of use, usefulness, control, response speed of a mobile device has a positive influence on the usability of it (Lee et al., 2015).

2.5 Mobile marketing acceptance

On a global scale, mobile technology usage and mobile marketing research has been done in developed markets, however, according to Shankar and Balasubramanian (2009), the fastest growth is occurring in emerging markets, both small and large. For instance, in 2009, China had the main pool of mobile device users and India had the largest number of new mobile adopters each month (Shankar & Balasubramanian, 2009). Furthermore, the user base of mobile devices is increasing in many African countries (Shankar & Balasubramanian, 2009), thus, making Africa a crucible place for mobile phone entrepreneurship and innovation (Etzo & Collender, 2010).

Mobile technology access and rapid growth creates new opportunities for marketing practitioners and managers (Kim, Kim & Wachter, 2013). Mobile phones offer both customised and personalised marketing strategies for businesses (Kim, Kim & Wachter, 2013). It allows consumers to receive a diversity of experiences that frequently compel them to constantly engage in activities and initiatives that create value and fulfilment for them (Kim, Kim & Wachter, 2013). Moreover, due to the continual development in mobile technology and augmented penetration of mobile devices, the mobile channel has transformed into one of the ultimate and crucial marketing vehicles (Cochrane, 2014; Hakansson, 2014; Kim et al., 2013; Lee, Phaal, & Lee, 2013; Salehan & Negahban, 2013).

Mobile Technology acts as an enabler for business entities to institute a universal presence and communicate with consumers anywhere and at any given time (Varnali & Toker, 2010). Mobile marketing as a communication and advertising channel provides companies with an opportunity to build and foster customer relationships

while generating revenue. According to Varnali and Toker (2010), the mobile marketing industry is growing and was projected to generate approximately 400 billion by the end of 2015 (Erturkoglu, Zhang & Mao, 2015).

These developments on the industry and consumer environment has encouraged scholars (Mimosette, & Djumene, 2015; Rohm, Gao, Sultan & Pagani, 2012; Watson, McCarthy, & Rowley, 2013) to explore the construct of mobile marketing. Studies on mobile marketing are scattered around a variety of journals from various disciplines such as marketing, management, business and technology (Martí Parreño, Sanz-Blas, Ruiz-Mafé & Aldás-Manzano, 2013; Persaud & Azhar, 2012; Watson, C., McCarthy & Rowley, 2013).

According to Lu et al. (2009), mobile marketing acceptance is measured by behavioural intent towards mobile marketing. Researchers have investigated the uniqueness of mobile marketing platforms and found that the mobile platforms have overtaken the internet, becoming the main form of communication and a way to access content globally (Gao et al., 2013).

Several authors (Hsu, Lu, & Hsu, 2008; Mahatanankoon, 2007; Bhatti, 2007) have argued that mobile marketing acceptance is likely to be impacted by a user's attitude, individual level perceptions and personal tendencies. Other scholars (Kim, Lee, & Kim, 2008; Newell & Meier, 2007) argue that social and peer influence impacts on the acceptance or adoption of mobile marketing. Additionally, Varnali and Toker (2010) state that the acceptance of the mobile medium itself, cultural dimensions, credibility and relevance of the content, the level of trust towards the service provider and the context of the marketing message play a huge role in mobile marketing acceptance.

Though attitude towards mobile marketing is included amongst the determining factors of mobile marketing acceptance (Varnali & Toker, 2010), several scholars such as Bauer, Reichardt, Barnes and Neumann (2005) argued that information and entertainment value have the major impact on the attitude towards the adoption of mobile marketing. Moreover, other scholars (Haghirian & Inoue, 2007) found that credibility and the information carried out by the mobile marketing message has the strongest influence on the user's attitude towards mobile internet marketing.

However, several other scholars (Chowdhury, Parvin, Weitenberner, & Becker, 2006; Lee & Jun, 2007) have argued that the effect of entertainment and informative messaging on attitude is insignificant in the mobile marketing context. In another study conducted by Barutc (2007) on attitudes towards mobile marketing, it was found that consumers who are more involved and price conscious have a positive and stronger attitude towards mobile marketing. Moreover, discount vouchers also play a major role in the individual's intent to adopt mobile marketing (Barutc, 2007). However, as specified by Barutc (2007), this tends to differ for users without internet access concerning their attitude towards mobile marketing, shopping and entertainment.

In research on understanding and implementing mobile social marketing, it was found that consumers favour to receive marketing communication from another consumer rather than from an enterprise (Wais & Clemons, 2008). This serves as evidence that there is a strong relation on a consumer's attitude and intent to adopt mobile marketing (Varnali & Toker, 2010).

Moreover, mobile marketing acceptance has been examined along two dimensions, the high degree of interactivity involvement and the marketing content based on the user's location (Gao et al., 2013). Furthermore, mobile marketing acceptance from a user's point of view refers to respondents' interest and intentions to participate in activities such as promotional offers on their mobile device (Sultan, Rohm & Gao, 2009). Additionally, Watson McCarthy and Rowley (2013) elaborate on this statement by stating that mobile marketing can be utilised to develop user engagement or participation with a brand, through mobile phone text messages, permission based marketing and mobile advertising.

2.6 Conceptual model

Drawing from the existing literature from interactivity, usability and mobile marketing acceptance, a conceptual model and framework was developed and is shown in Figure 2. The conceptual model comprises six constructs, that is, four predictors (interactivity dimensions: perceived control, perceived responsiveness, nonverbal information and perceived personalisation), one mediator (mobile phone usability) and an outcome (mobile marketing acceptance). The model shows that interactivity has a direct impact on usability. Therefore, the provision of mobile phone usability influences

mobile marketing acceptance. The detailed explanation of the relationships and significance among these constructs is provided in the hypotheses developed henceforth.

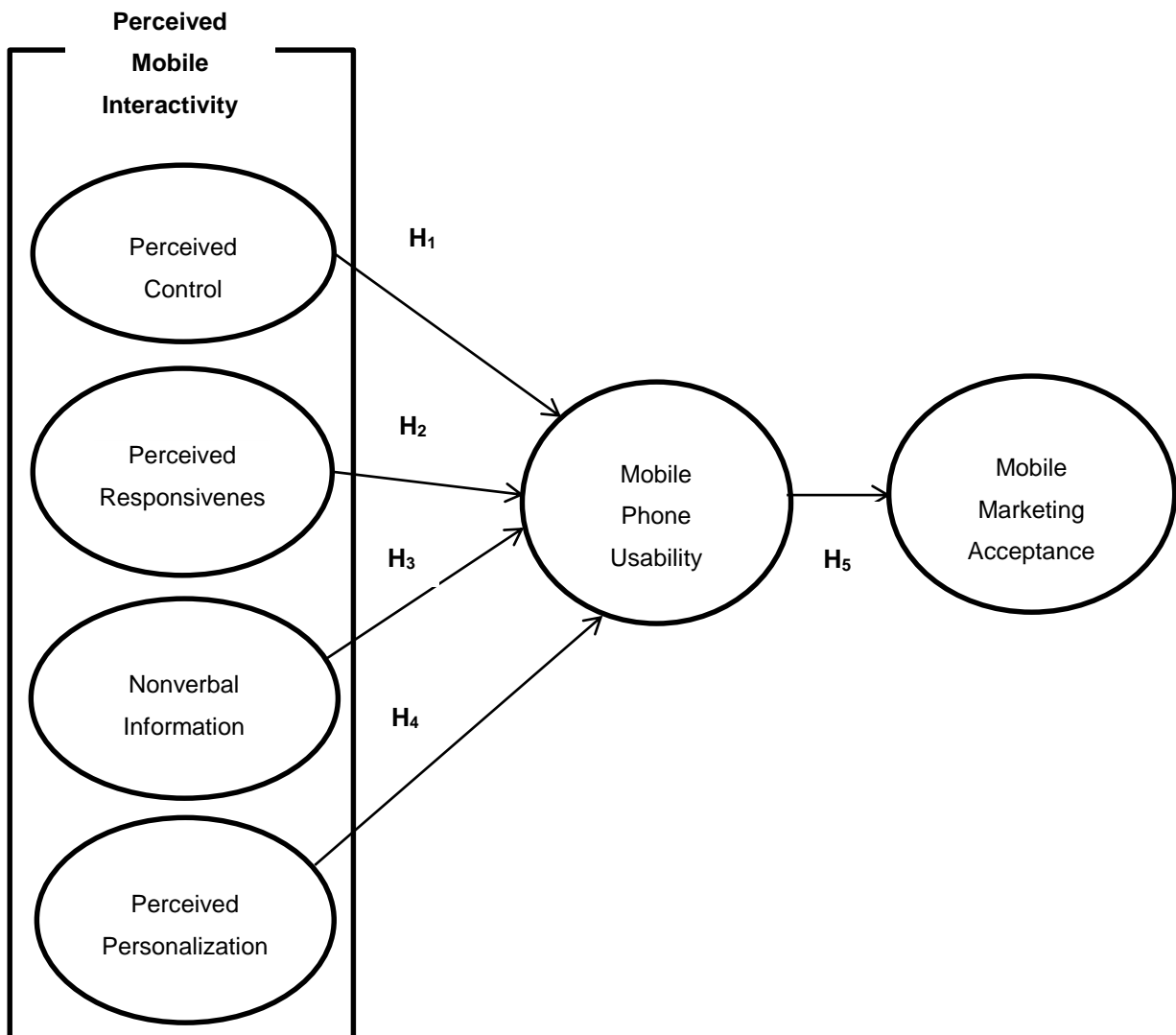

Figure 2: Conceptual model

2.7 Hypothesis development

2.7.1 *Perceived control and mobile phone usability*

Perceived control according to Park, Baek, Ohm and Chang (2014) has been associated with user flow state, and the possible approaches to comprehend flow state is to consider it as a specific function of control which is deeply associated with the

user's perceptions and activities. Park et al. (2014) point out that a user in a flow state tends to demonstrate his or her intrinsic stimuli while executing and completing a particular task, and feel consistency amongst self-awareness and activities.

Therefore, with regard to flow state in the context of mobile technologies, the greater the level of being skillful in utilising a mobile device occurs, the greater the degree of controlling that mobile device (Luarn & Lin, 2005). In support of this proposition are previous scholars (Koufaris, 2002; Lu, Zhou, & Wang, 2009; Venkatesh, 2000) who presented that perceived control is a fundamental factor to determine perceived usability and the enjoyment of a particular technology. This indicates that it is enjoyable and easier when users feel high levels of flow state and perceived control (Park et al., 2014).

One clarification is that perceived control has a positive relation with readiness, accessibility and connectedness, which enhances and enriches the user's capability to complete a task and their confidence (i.e., self-efficacy) in attaining goals by utilising the technology (Shin, 2009). Additionally, users who perceive that they have robust control over a technology system are more likely to perceive that the technological system or device is easier to use when it comes to completing and satisfying their expectations and tasks (Shin, 2009). Furthermore, perceived control has been found to significantly influence the perception of ease of use (Lee et al., 2015; Mun et al., 2006). Thus, in agreement with the reviewed literature this study hypothesises that:

H₁: Perceived control has a positive effect on mobile phone usability

2.7.2 Perceived responsiveness and mobile phone usability

Perceived responsiveness has been identified that, in the case of technological systems, it is predicted to contribute directly to overall satisfaction (Van Riel et al., 20014). Responsiveness communicates to the ability of a system or mobile device to respond quickly to requests for support (Zeithaml, Parasuraman, & Malhotra, 2000). For instance, in online supporting services, the speed with which the website reacts provides assistance to difficulties and taking care of follow-ups seems to be an essential quality (Van Riel et al., 2004).

Although communication in diverse forms is at the heart of all systems service interactions and an essential element of these services (Grönroos et al., 2000), it is expected that the degree to which the technological system's support facilitates effective and efficient communication and interaction with the user to be a key satisfier. Moreover, according to Lee et al. (2015), perceived responsiveness of a mobile device or phone has a positive influence on user perceived usability. Thus, in agreement with the reviewed literature this study hypothesises that:

H₂: Perceived responsiveness has a positive effect on mobile phone usability

2.7.3 Nonverbal information and mobile phone usability

Nonverbal communication, such as design aesthetics, affect ease of use and perceived usefulness of use of an interactive system (Lavie & Tractinsky, 2004); these must be designed to support the communications that is intended to be delivered to users in order for the users to find it useful. Misappropriation of design aesthetics can lead to unsuccessful communication and therefore become a disadvantage (Li & Yeh, 2010). For example, in connection with this statement, Lavie and Tractinsky (2004) state that the design aesthetics must work with website design components, for example, usability and customisation.

Li and Yeh (2010) established that an improved version of a web page, for example, decorative font, colours, graphical design and website with an image header positively affect the user's impression of the site, which include perceived usefulness compared to a simple web page layout. Lavie and Tractinsky (2004) recommended that users perceive and assess features of the system or a device such as, aesthetics, usefulness and ease of use when being involved in an interactive system. Moreover, Li and Yeh (2010) state that perceived visual aesthetics of a mobile website influence consumer perception of ease of use, customisation and usefulness. Additionally, access to relevant information via multiple channels is anticipated to have a positive contribution to the search ability and understandability of provided information, mutually leading to higher user learnability. Thus, drawing from the discussion above and empirical evidence, it is hypothesised that:

H₃: Nonverbal information has a positive effect on mobile phone usability

2.7.4 ***Perceived personalisation and mobile phone usability***

According to Asif and Krogstie (2013), personalisation of mobile devices or services has a primary objective of containing information load and providing highly relevant and pertinent contents to the users. Accordingly, Personalisation is measured as a key determinant of success of mobile services and devices (Arbanowski, Ballon, David, Droegehorn, Eertink, Kellerer & Popescu-Zeletin, 2004). For instance, preference centred news are provided to mobile devices and customised according to the preferences of the user and by tracking the user's behaviour (Shapira, Shoal, Tractinsky & Meyer, 2009).

Likewise, contents can be modified according to the mobile device profile so that the user can easily browse and navigate (Asif & Krogstie, 2013). According to Blechschmidt, Wieland, Kuhmünc and Mehrmann (2005), user satisfaction is determined by the technical, design, quality and usability of the mobile devices or services. The evaluation phase of the personalisation procedure focused on assessing the influence of personalisation by determining how much the user is satisfied and pleased with the personalisation (Adomavicius & Tuzhilin, 2005).

Authors (Asif and Krogstie, 2013) also advocate that there is an important demand to improve suitable metrics to determine personalisation control. Moreover, it is recommended that determining the influence of personalisation can assist to comprehend the deficiencies of procedures of personalised delivery (Asif & Krogstie, 2013). It can also assist to function as feedback for possible developments to other elements of the personalisation process (Asif & Krogstie, 2013). Jameson (2009) has deliberated system competence, controllability, predictability, unobtrusiveness, privacy, user experience and comprehensibility as usability issues of personalised systems.

The goal of personalisation is to increase and enhance the usefulness and acceptance of services and information (Arbanowski et al., 2004). According to Vassiliou, Stamoulis and Martakos (2002), personalisation is about what the users perceive as an added value. Hence, there is a necessity to assess the personalised offers in terms of user satisfaction (Asif & Krogstie, 2013). An empirical study conducted by Rao Hill,

and Troshani (2010), found that the greatest decisive factors or determinants in adoption and acceptance of personalised mobile services are perceived enjoyment and perceived ease of use.

Moreover, user satisfaction is influenced by personalisation (Asif & Krogstie, 2013). A similar work done by Liang, Lai and Ku (2006) measured personalised services and evaluated user satisfaction using four scopes, namely, personalised service, system value, information content and user interface. Personalisation provides a mean of satisfying users' needs more efficiently and effectively, as a result increasing user fulfilment (Asif & Krogstie, 2013). By delivering effective personalisation, high levels of user experience and satisfaction can be attained (Asif & Krogstie, 2013). Scholars (Van Velsen, Van Der Geest, Klaassen & Steehouder, 2008) have used different constructs associated with user-centred personalisation when evaluating personalised systems, namely, perceived usefulness, appropriateness of adaptation and usability.

Pahnla (2008) states that perceived expectancy and perceived relevancy are used as evaluation determinants to understand the behaviour and attitude of users towards personalisation. It was found that the relation between intention, perceived relevance to attitude and actual use was substantial and significant (Van Velsen et al., 2008). Furthermore, according to Arbanowski (2004), the goal of personalisation where mobile devices are concerned is to enhance and increase the usefulness or ease of use and the acceptance of communication, information and services. Thus, in agreement with the reviewed literature this study hypothesises that:

H₄: *perceived personalisation has a positive effect on mobile phone usability*

2.7.5 Mobile phone usability and mobile marketing acceptance

Preceding studies have supported the perception that there is a positive correlation among perceived usability and attitude and perceived usability and enjoyment (Park et al., 2014). Moreover, in research conducted by Nah, Zhao and Zhu (2003) it was found that perceived enjoyment is a prominent determinant of perceived usability of a mobile device.

In addition, usability goals such as, learnability, effectiveness and efficiency are believed to be positively correlated with how individuals assess their user experience and involvement with technology, whether enjoyable or satisfying (Oliveira, Cherubini & Oliver, 2012). However, according to Frøkjær, Hertzum and Hornbæk (2000), these correlations depend in a multifaceted way on the application domain, the user's context and the experience of use. Furthermore, efficiency, satisfaction and effectiveness as stated by scholars (Hornbæk & Law, 2007) should be measured as different goals.

In this regard, Heo, Ham, Park, Song and Yoon (2009) created a model to assess the usability of mobile services, and presented that there were relationships amongst usability and the construct of user experience, namely, satisfaction. Additional support for this hypothesis derives from TAM (Cheng et al., 2015) that has been adapted to study cases of mobile services acceptance and adoption (Niklas & Strohmeier, 2011). In both developments, significant links between usability goals and user satisfaction were identified (Oliveira et al., 2012).

Oliveira et al. (2013) state that for a number of years, the concept of user satisfaction together with interactive products was essentially acknowledged as part of usability. This agrees with the earlier statement by Rogers, Sharp and Preece (2011) cited in Oliveira et al. (2013) who stated that usability goals, safety, learnability, utility, memorability effectiveness and efficiency are universally positively correlated with how users assess their experience with technology in terms of it being enjoyable, engaging and satisfying. Niklas and Strohmeier (2011) also found that there is a strong relation between usability and user satisfaction.

Moreover, according to Benbunan-Fich (2001), measuring perceived usability can be achieved through the observation of a user's interaction with the interface, by evaluating the ease of use and the overall user's satisfaction with the interface. As such, perceived usability is related not only to the user's acceptance of the interface's fundamental system through intercession, but also includes user satisfaction (Oliveira et al., 2013).

In other literature, prior research conducted by scholars (Hassenzahl, Beu & Burmester, 2001; Schenkman & Jonsson, 2000) has indicated that user perceptions towards a system's interface is extremely correlated to usability and meaningfully impacts on the overall system adoption and acceptability. Moreover, Acton, Golden, Gudea and Scott (2004) state that usability influences the intention to accept or adopt a system based on user attitudes, perceptions and intents towards features of the interface. These include perceptions of usefulness, ease of use and intents towards the actual usage and acceptance of the system (Acton et al., 2004).

Likewise, Venkatesh and Davis (2000) also confirm that prior studies have established that perceived usability is a significant factor influencing usage behaviour and user acceptance of information technologies, which is positively correlated with recent studies (Cheng et al., 2015; Niklas & Strohmeier, 2011). Thus, drawing from the discussion above and empirical evidence, it is hypothesised that:

H₅: *usability has a positive effect on mobile marketing acceptance*

2.8 Conclusion of Literature Review

As per the key findings from the literature review discussed above, the interactivity of a mobile phone or device may have a strong effect on perceived usability. According to Lee et al. (2015), high levels of interactivity signifies that a user can control a mobile phone or device as preferred while the mobile phone provides personally relevant, appropriate and useful information in a timely manner via multiple channels. Usability on the other hand primarily measures how easy it is to understand, learn, find and use a mobile device (Lee et al., 2015). Perceived behavioural control has been found to greatly influence the ease of use perception (Mun et al., 2006). Furthermore, access to more personally relevant information and communication via multiple channels immediately is proposed to positively contribute to the searchability and understandability of presented information, collectively leading to higher learn ability.

Therefore, it can be concluded that perceived interactivity influence usability of a mobile phone, thus influencing mobile marketing acceptance (Lee et al., 2015). Henceforth, this study aims to examine the previously mentioned statement, aligned

to the overall hypothesis. Furthermore, from a South African viewpoint it would be beneficial to assess if the factors mentioned above do influence mobile marketing acceptance in the informal hair-care business, given that there is little evidence in research on this subject matter.

CHAPTER 3. RESEARCH METHODOLOGY

This chapter describes and discusses the methodology, defined by Bryman (2012) as the means of understanding the full research process, which includes logical assumptions, moral principles, socio-organisational context and the political impact of new knowledge from the research venture that is employed in this study. The research paradigm (3.1); the research design (3.2); the target population and sampling (3.3); the questionnaire design and measurement (3.4); the data collection technique (3.5) as well as the data analysis and interpretation is articulated (3.6).

Subsequently, to complete the discussion the reliability and validity measures applied in (3.7), the demographic profile of respondents in (3.8) and the administrative limitations of the research procedure in (3.9) conclude this chapter.

3.1 Research paradigm/philosophy

Bryman (2012) and Babbie (2013) define research method as a general approach, and method that is used to conduct social research or a chosen research topic. According to Neuman (2014), the chosen research method used in conducting a study will differ depending on whether it is primarily qualitative, quantitative or mixed. For the purpose of this study, a quantitative method, also known as positivism (Bryman, 2012), was undertaken.

Quantitative research emphasises quantification in data collection and analysis; it is an objective and deductive research strategy that incorporates a scientific model of the research process, particularly, one that is influenced by positivism (Bryman, 2012; Lewis & Thornhill, 2009). Moreover, in a quantitative study, the emphasis is placed on the testing of theories (Bryman, 2012; Kolb, 2008). Neuman (2014) emphasises that in general, a quantitative research takes a linear approach and accentuates objectivity in a way that it explicitly involves causal explanations and standardised procedures.

The quantitative method process involves a sequence of steps that precede data collection, which includes, narrowing the research topic to more of a focused question, confirm theoretical concepts into exact constructs or variables in order to form an hypotheses to test (Neuman, 2014). Wagner, Kawulich, and Garner (2012) reiterate

by stating that the data collected in a quantitative study is used to explain and describe a social phenomenon, determine relationships between constructs and looking for cause and effect by testing the hypothesis and determining the underlying issues of causality. Therefore, this provided justification for the chosen method in order to empirically examine the relationship between the constructs in question, namely, perceived control, perceived responsiveness, nonverbal information, perceived personalisation, mobile phone usability and mobile marketing acceptance.

3.2 Research Design

According to Bryman (2012), research design denotes a structure used for data collection and analysis. Babbie (2013) defines research design as a set of decisions employed in a study concerning what topic is to be studied, amongst what population with what research approach or method and for what purpose. Wagner et al. (2012) defines research design broadly, stating that in social research the design communicates how the study will be conducted.

There are five types of generic research designs as stated by Bryman (2012); comparative design case study, cross-sectional or survey design, longitudinal design, and experimental design. For the purpose of this study, a cross-sectional study also known as descriptive research was carried out in order to describe the statistical features of the chosen sample. A cross-sectional design is a research design that involves data collection carried out at one-time point or at single point in time in order to collect a body of data that is quantifiable in connection with two or more constructs, which are then studied to detect or identify relationships or patterns of association (Bryman, 2012).

Neuman (2014) reiterates by stating that a cross-sectional design does not only involve the data collected on more than one case but this research design inspects data on many cases at one point in time. The reason this study committed to a cross-sectional design is that it allowed for collection of data to be done in a short period of time at a given time point in order to find the occurrence of the outcome of interest for the chosen population, being the informal sector hair-care business operators or entrepreneurs in South Africa. Moreover, the reason for choosing a cross-sectional design in this study is that it allowed for large data to be collected and analysed

quantitatively. According Kolb (2008), a common tool used to conduct a descriptive study is a survey. A questionnaire allows for a big quantity of data to be collected from a sizeable population (Saunders, Lewis & Thornhill, 2009).

Moreover, a cross-sectional design allows for many different constructs or variables to be measured at the same time, for example, in the study it assisted in investigating the relationships between measured constructs in order to prove or support the proposed hypotheses statistically. Since this study utilised statistical tools to analyse data, descriptive research assisted in investigating the relationship between interactivity and mobile phone usability, then mobile phone usability and mobile marketing acceptance.

3.3 Target population and sample

3.3.1 *Target population*

Bryman (2012, p. 714) defines target population as the “universe of units from which a sample is to be selected.” Neuman, (2014) defines target population as the concretely stated large group of many cases from which a sample is selected by a researcher and to which the outcomes or findings from the sample are generalised. Moreover, the choice of research partakers or participants should be determined by the focus of a study, thus allowing the researcher to meet the aim of the research and answer the research question (Symon & Cassell, 2012). However, according to Symon and Cassell (2012), choosing research participants is likely to be challenging until a researcher is clear regarding the focus of their research. Therefore, the targeted population for this study included all informal hair-care businesses in Johannesburg, South Africa.

3.3.2 *Sampling and sampling method*

a) Sampling frame

Bryman (2012) defines a sample frame as a list of all items in the targeted population from which a sample will be taken. In this study, the sampling frame included all

informal hair-care businesses operators in the east of Johannesburg and the Johannesburg CBD.

b) Sample size

Sampling is defined as the decisions made by the researcher about what sample size (the quantity of cases in a sample) is to be derived from the chosen population, thus the larger the sample, the more accurate and representative it is likely to be (Bryman, 2012; Neuman, 2014). Symon and Cassell (2012) elaborate by stating that the sample size is dependent upon collected data pending no new information and themes that are observed, that is, until capacity is reached. The sample size for this study consisted of 312 respondents. The size was particularly chosen due to its adequacy to run on the Analysis of Moment Structures (AMOS) software.

c) Sampling method

Sampling constitutes the number of cases in the sample that are extracted from the population of interest due to accessibility, convenience and financial constraints, allowing the researcher to fairly make generalisations that result back to the chosen population (Neuman, 2014). This research utilised the generic purposive sampling, also known as convenience sampling in quantitative research. Convenience sampling is a form of non-probability sample that involves a sample that is chosen based on its obtainability and proximity to the investigator (Bryman, 2012). Neuman (2014) states that convenience sampling is a non-random sampling method whereby the researcher chooses anyone they happen to come across in no special order. The reason this research committed to a convenience sampling method is that the informal hair-care businesses are scattered around the Johannesburg area and in no formal order, therefore, convenience sampling allowed for accessibility and to conveniently distribute the survey questionnaires.

Table 1: Profile of Respondents

Description of respondent type	Number sampled
Hair-care business operators in the informal sector in Johannesburg (East and CBD), Gauteng, South Africa	312

3.4 Data collection instrument

Neuman (2014) stipulates that data collection instruments can be assembled into two groups based on the type of data collected, in a quantitative study, collecting of data is in the form of numbers, and a qualitative research it is in the form of words or pictures. Moreover, in a quantitative study, the data collection instrument is denoted as 'research instrument', which simply implies a self-completion questionnaire and a structured interview (Bryman, 2012). Babbie (2013) states that a questionnaire is an example of a data collection instrument particularly designed to produce information that will be useful for analysing data. Additionally, questionnaires are primarily used in survey research but also in field studies, and other modes of observation and experiments (Babbie, 2013). Bryman (2012) states that there are two forms of data collection instruments used in the data collection process, that is, observation schedule and interview schedule. For the purpose of this research, an interview schedule in a form of a survey questionnaire was adopted as a method of data collection.

An interview schedule is commonly utilised in a structured interview and involves a collection of questions intended to be asked by an interviewer (Bryman, 2012). Wagner et al. (2012) adds by stating that an interview entails a co-operative dialogue, concerning the interviewer and the interviewee. The interviewer asks the participant questions in order to collect data about beliefs, opinions, views, experiences, ideas and behaviours (Wagner et al., 2012). In agreement with the aforementioned definitions, Neuman (2014) emphasises by stating that in an interview schedule, there are two fundamental elements, namely, a set of questions that are designed to be

asked as worded and the instructions for the interviewer on how to continue through the questions. The questions have to appear in the order in which they are going to be asked so that they can be administered by the interviewer precisely as they are written, who also records the responses accurately (Neuman, 2014). Using an interview schedule allows the questionnaire to be self-administered. Therefore, the questionnaire was fully structured (Neuman, 2014.).

Fully structured data collection Instrument, also referred to, as a 'structured interview' is a study interview typically in the context of a survey research in which all participants are asked exactly the same questions in accurately the same order (Bryman, 2012). Referred to by Neuman (2014) as a 'survey research interview', a survey research utilises a formal written questionnaire or formal interview to collect information on the behaviours, attitudes, beliefs, and backgrounds of a large number of people.

Symon and Cassell (2012) define a fully structured data collection instrument as an intensified structure that tends to escalate the prospect of the interviewees to reply to parameters set by the researcher rather than following themes. The scholars regard it as stimulating or essential, thus plummeting novelty and richness, but also enabling an easier sorting, comparison and analysis of material (Symon & Cassell, 2012). A survey questionnaire is the most common quantitative technique used to collect primary data (Saunders, Lewis & Thornhill, 2009), and was used as a research instrument to conduct this study.

The survey questionnaire comprised two sections; section A and B. Section A required the respondents to fill in their background information. Section B measured perceived control, perceived responsiveness, nonverbal information, perceived personalisation, mobile phone usability and mobile marketing acceptance. Moreover, a seven-point Likert scale ranging from 1 = strongly disagree to 7 = strongly agree was used to measure all these items. The reason for using a seven-point Likert scale is that it gave more chances to get accurate responses from the respondents since the options were many.

The research was operationalised and adapted from previous studies to suit current studies. Variables were measured on the following item scales, which were also adapted from respective sources, as demonstrated below:

Table 2: Measurement instruments and respective sources

Construct	Scale reference	Adapted scale (number of instruments)
Perceived control	Lee et al. (2015)	4 item scale
Perceived responsiveness	Lee et al. (2015)	3 item scale
Nonverbal information	Lee et al. (2015)	4 item scale
Perceived personalization	Lee et al. (2015)	4 item scale
Mobile phone usability	Lee et al. (2015)	5 item scale
Mobile marketing acceptance	Sultan et al. (2009)	3 item scale

3.5 Data collection technique

According to Kolb (2008), the most common technique used for collecting data in a quantitative research is a survey. The self-administered questionnaire was used. The reason for using the self-administered questionnaire is that it has the following advantages (Kolb, 2008):

- Cheap to administer;
- Quicker to administer;
- The interviewer cannot lead the respondent to provide a specific answer and;
- Respondents can complete the questionnaire in their own time.

3.6 Data processing and analysis

3.6.1 Data processing

In the context of quantitative research, data processing is once information has been collected and prepared to be quantified to produce meaningful information; some of this information can be processed in a relatively straightforward way, for an instance, people's ages, gender, income (Bryman, 2012). However, for the other constructs,

quantification of information will entail coding (Bryman, 2012). Neuman (2014) states that several things are done to the raw data in order to see what can be said about the hypotheses, which includes, reorganising them into a form appropriate for computer entry, presenting them in graph or charts to summarise their features, and interpreting or giving theoretical meaning to the results or findings. Babbie (2013) states that the raw observations are naturally in the form of surveys with boxes checked and responses written in spaces which are all transmitted to a computer (Babbie, 2013).

The data analysis procedure for this study was as follows,

1. Coded data on excel
2. Data cleaning – checked for mistakes and dealt with missing data by using the simple imputation method as suggested by Lee (2015), where missing data was replaced by a score that reflected the usual answers for that question. This method was applied because the proportion of missing data was moderate.
3. Performed descriptive analysis using SPSS software
4. Performed Confirmatory Factor Analysis (CFA) using the Analysis of Moment Structures (AMOS) for Structural Equation Modelling (SEM)
5. Performed path modelling using AMOS for SEM in order to explain the relationship between constructs and measures. The signage whether positive or negative and the significance of the relationship using probability value (P-value) was also executed.

3.6.2 *Data analysis*

According to Bryman (2012), in quantitative research, during data analysis the researcher uses a number of quantitative data examination techniques in order to reduce the amount of data collected, to test for relations among constructs and to develop methods of presenting the results of the analysis. This step typically requires the use of computer software in order to manipulate the numerical data to generate tables, graphs, statistical measures, charts (Bryman, 2012).

Furthermore, Babbie (2013) states that analysing data includes determining the meaning of collected materials in relation to the aim of the research. Once the collected data are in an appropriate form, the researcher is ready to interpret the findings for

the purpose of drawing conclusions that reflect the theories, hypotheses, interests and ideas that initiated the investigation (Babbie, 2013). For analysing and interpreting data, a Structural Equation Modelling (SEM) approach, which includes Confirmatory Factor Analysis (CFA) and path modelling was utilised.

SEM is a powerful statistical technique for the development, modification and validation of theories and hypothesised relationships between variables (Violato & Hecker, 2007). Moreover, through this framework, researchers are able to translate theory into a testable model (Violato & Hecker, 2007). Therefore, statistical software that was used included SPSS and the Analysis of Moment Structures (AMOS) software.

3.7 Validity and reliability

Reliability and validity are essential measures in establishing and measuring the quality of research (Bryman, 2012; Babbie, 2013). Neuman (2014) elaborates by stating that reliability and validity are measures that assist in establishing the credibility and truthfulness of the research results.

3.7.1 Validity

In quantitative research, validity denotes the extent to which the variables, as measured by the study, reflects the hypothesised constructs and whether an indicator that is devised to gauge a theory or model really measures that theory (Bryman, 2012; Fellows & Liu, 2015; Wagner, 2012). Neuman (2014) states that validity suggests truthfulness of a theory or concept. To check for validity, this research used convergent validity and discriminant validity. For convergent validity, the two indicators applied for this measure were factor-loadings and Item total correlation; and for discriminant validity, two indicators were also used, namely, average variance extracted (AVE) and inter-construct correlation matrix.

3.7.2 Reliability

Reliability is defined as the extent, which a measure of a concept or study is stable, estimating the reliability or consistency of a measurement (Bryman, 2012; Wagner,

2012). Babbie (2013) states that reliability is a quality of measurement method that proposes that the same data would have been collected each time repeatedly from same phenomenon, yielding consistent results that are similar to the previous. To ensure reliability in this study, the variables were measured using the Cronbach's Alpha generated from the SPSS software and to prove if it was reliable, the recommended threshold of 0.6 should be exceeded or above it. Moreover, reliability was also checked using composite reliability, which was generated through AMOS software when performing Confirmatory Factor Analysis (CFA) in SEM.

3.7.3 *Model fit*

Model fit is used to determine how well the model fits the sampled data (Hooper, Coughlan & Mullen, 2008). The model fit of the instruments was checked using Confirmatory Factor Analysis (CFA). The following statistical indicators listed below were used to check if the data fit to the research model (Hooper et al., 2008; Larwin and Harvey (2012; McDonald & Ho, 2002),

- Chi-square value – should be less than 3
- Goodness of Fit Index (GFI) – should be 0.9 or greater than
- Augmented Goodness of Fit Index (AGFI) – should be 0.9 or greater than
- Comparative Fit Index (CFI) – should be 0.9 or greater than
- Normed Fit Index (NFI) - should be 0.9 or greater than
- Relative Fit Index (RFI) - should be 0.9 or greater than
- Incremental Fit Index (IFI) – should be 0.9 or greater than
- Tucker-Lewis Index (TLI) – should be 0.9 or greater than
- Random Measurement of Standard Error Approximation (RMSEA) – should be less than 0.08

3.7.4 *Path modelling*

Path modelling was conducted to test the hypotheses in this study. Path modelling explains the relationship between constructs and measures (Yanos, Roe, Markus & Lysaker, 2015). Therefore, for path modelling, the signage was checked whether positive or negative and the significance of the relationship using probability value (P-value) was also checked.

3.8 Demographic profile of respondents

In quantitative research, respondents are people who provide data for analysis by filling in a survey questionnaire (Babbie, 2013). For instance, the researcher could commence a survey in which divorces were the unit of analysis, but he or she would need to administer the survey questionnaire to the participants going through a divorce (Babbie, 2013). The demographic profile of respondents included individuals that operate in informal hair-care businesses, which comprised females and males; between the ages of 17 to 46 upwards; with high school to tertiary education; both single and married and employed and self-employed.

3.9 Limitations of the study

Since the study was quantitative in nature, the use of probability sampling technique may have significantly limited the ability of the research to make broader generalisations from the findings or results in relation to the studied population. The quality of research may have also been reduced due to the respondents' providing information that is biased due to the fact that they may have chosen to answer in a manner that reflected their preferred characteristics, rather than their actual characteristics.

3.10 Ethical considerations

Ethical values in social research revolve around certain issues that recur in different appearances, namely, firstly, whether there is harm to the partakers; secondly, whether there is a lack of informed consent; thirdly, whether there is an invasion of privacy and lastly, whether deception is involved (Bryman, 2012). Neuman (2014) states that the concept of ethics defines what is or is not appropriate to do, or what ethical or principled research procedure are encompassed. Many ethical issues require the researcher to balance two values, namely, the pursuit of scientific knowledge and the rights of those being studied or of others in society (Neuman, 2014). According to Wagner (2012), ethics is an issue and subject that must be carefully considered in each step of the research design and implementation process. During the data collection process the participants were referred to the first page of

the survey questionnaire so that anonymity was assured and any personal or safety concerns in terms of sharing the data collected was addressed. Respondents were informed that the data collected would be used for a Master's degree research project and was conducted for academic purposes only. Moreover, respondents participated in this study voluntarily and were informed that they were free to withdraw at any given time. Please see survey questionnaire in the appendix A.

3.11 Summary

This chapter addressed the research paradigm, research design, target population, sampling, measurement instrument, data collection technique, data analysis, and reliability and validity measures. Furthermore, demographic profile of respondents and administrative limitations of the study were articulated.

CHAPTER 4. DATA ANALYSIS AND PRESENTATION OF RESULTS

4.1 Introduction

The aim of this section is to present results of the study pertaining to both section A (demographics) and B (scale of items) of the survey questionnaire. This chapter therefore discusses the data analysis followed by a discussion of the results of the study. The research results relate to the study objectives and questions that guided this research. The data was analysed to identify, describe and explore the main headings for this chapter which consists of the descriptive statistics; reliability and validity tests; the assessment of measurement instruments; CFA; path modelling; hypothesis testing results and summary of the results.

4.2 Descriptive statistics

The purpose of descriptive statistics is to quantify and describe the characteristics of samples of data in a numeric summary in order to confirm the normality of the data collected and analysed (Johnson, 2014; Wiley & Pace, 2015).

4.2.1 *Profile of respondents*

Table 1 presents a summary of the sample demographic profile and characteristics. The descriptive statistics were run on SPSS based on 312 respondents. The participants were asked to report their demographic information, comprising gender, marital status, age, highest academic qualification and occupation as outlined below.

The participants were predominantly females (63.1%) and males were (36.9%). The median age category of the participants was less than 35 years (57.7%). About (72.4%) of the participants were single. Approximately, (49.4%) of respondents had high school education, while about (28.2%) had neither high school nor university education. 11.9% had diplomas, about 9.3% had degrees and remainder (1.3%) had a postgraduate degree. About (69.2%) of respondents were self-employed, (29.5%) employed.

Table 3: Sample of demographic profile

Category		Frequency	Percentage (%)	Cumulative (%)
Gender	Male	115	36.9	36.9
	Female	197	63.1	100.0
	Total	312	100.0	
Marital status	Married	85	27.2	27.2
	Single	226	72.4	99.7
	Divorced	1	0.3	100.0
	Total	312	100.0	
Age	17 years or less	9	2.9	2.9
	18 - 25 years	66	21.2	24.0
	26 - 35 years	180	57.7	81.7
	36 - 45 years	52	16.7	98.4
	46 years upwards	52	1.6	100.0
	Total	312	100.0	
Qualification	High School	154	49.4	49.4
	Diploma	37	11.9	61.2
	Degree	29	9.3	70.5
	Postgraduate degree	4	1.3	71.8
	Other	88	28.2	100.0
	Total	312	100.0	
Occupation	Student	1	0.3	0.3
	Employed	92	29.5	29.8
	Self-employed	216	69.2	99.0
	Unemployed	1	0.3	99.4
	Other	2	0.6	100.0
	Total	312	100.0	

The participants were predominantly females 63.1% and males were 36.9%.

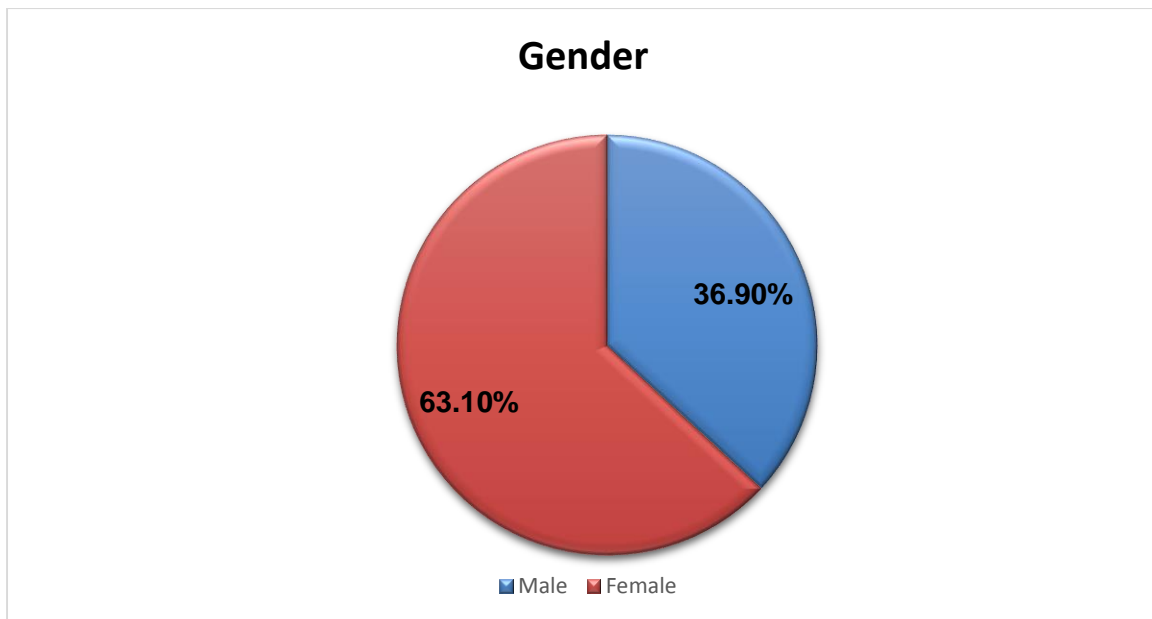

Figure 4.2.1a: Respondents' gender

About 72.4% of the participants were single and 27.24% married, whilst about 0.32% were divorced.

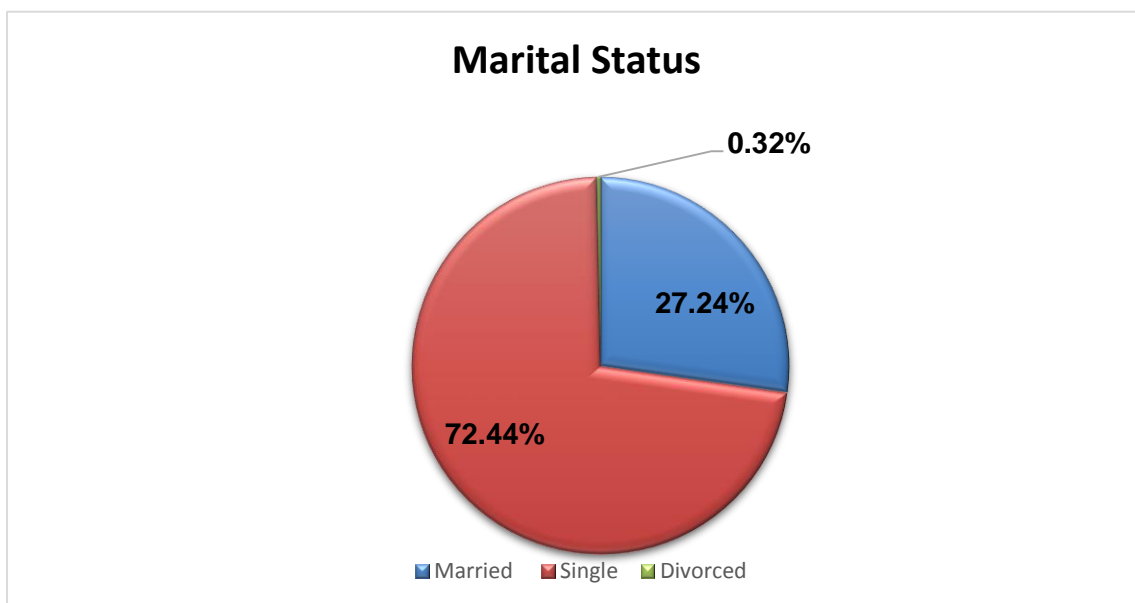

Figure 4.2.1b: Respondents' marital status

The median age category of the participants was less than 35 years 57.7%. 21.20% were between the ages of 18 - 25 years, 16.70% were 36 – 45 years, 2.90% were 17 years and younger and 1.60% were 46 years of age and older.

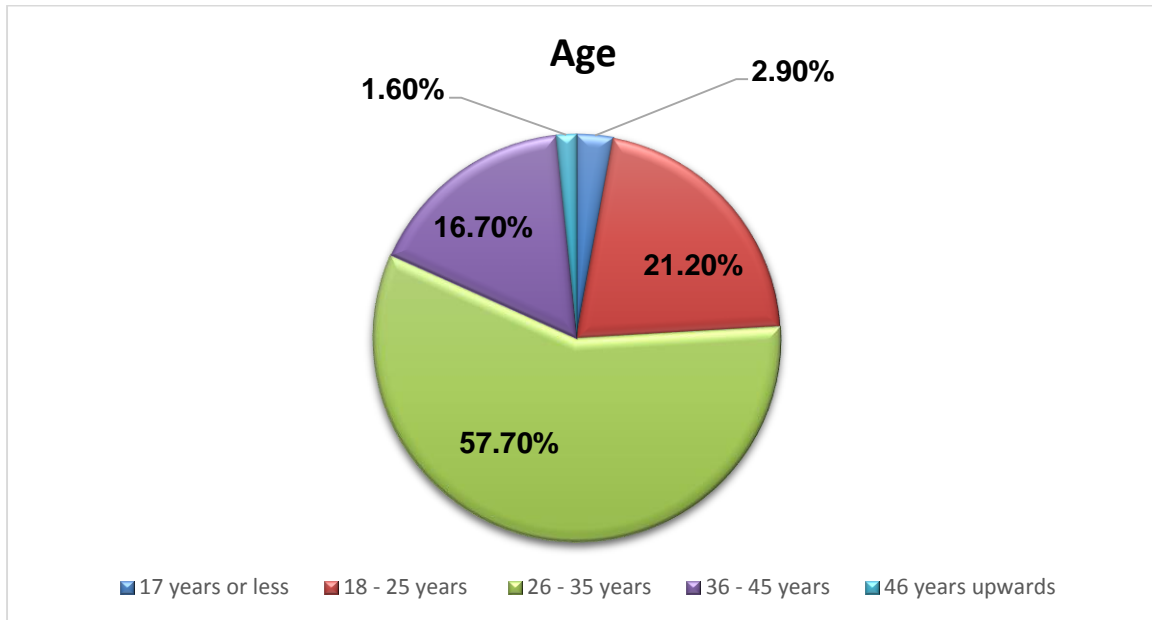

Figure 4.2.1c: Respondents' age

Approximately, 49.4% of respondents had high school education, while about 28.2% had neither high school nor university education. 11.9% had diplomas, about 9.3% had degrees and remainder 1.3% had a postgraduate degree.

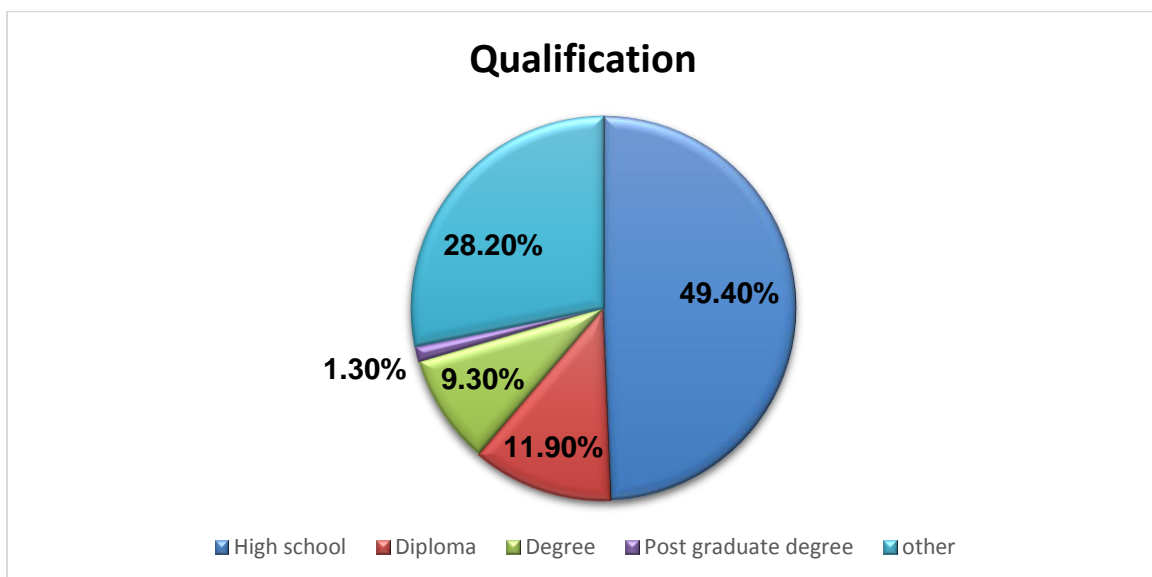

Figure 4.2.1d: Respondents' qualification

Approximately 69.2% of respondents were self-employed, 29.5% employed, 0.30% students and 0.30% unemployed.

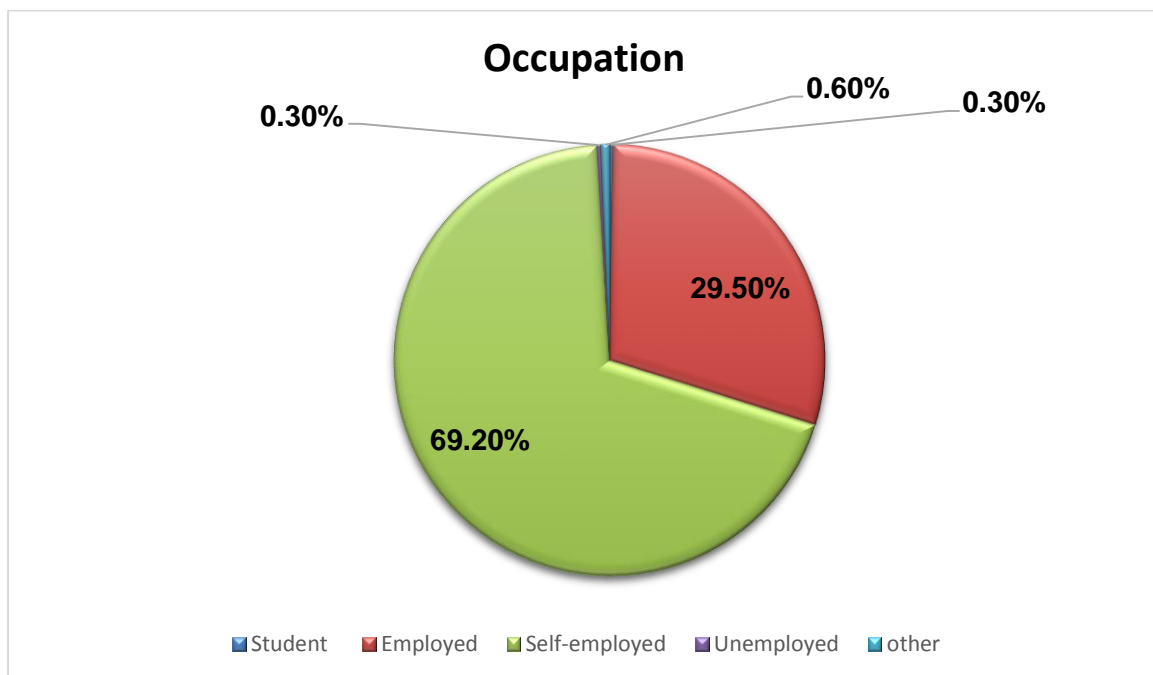

Figure 4.2.1e: Respondents' qualification

4.2.2 Summary of scale item results

The table below presents a summary of the frequencies and percentages of the measurement items of each construct.

Table 4: Frequencies (F) and percentages (%) of the measurement items

Items	Strongly disagree		Disagree		Slightly disagree		Neutral		Slightly agree		Agree		Strongly agree	
	F	%	F	%	F	%	F	%	F	%	F	%	F	%
Perceived control (PCL)														
PCL1	0	0	4	1.3	0	0	7	2.2	21	6.7	101	32.4	179	57.4
PCL2	0	0	2	0.6	0	0	3	1.0	22	7.1	102	32.7	181	58.0
PCL3	0	0	6	1.9	2	0.6	3	1.0	23	7.4	95	30.4	183	58.7
PCL4	0	0	2	0.6	0	0	11	3.5	18	5.8	95	30.4	186	59.6
Perceived responsiveness (PRS)														
PRS1	4	1.3	6	1.9	2	0.6	2	0.6	33	10.6	111	35.6	154	49.4
PRS2	6	1.9	6	1.9	2	0.6	4	1.3	32	10.3	112	35.9	150	48.1
PRS3	6	1.9	12	3.8	0	0	6	1.9	92	29.5	86	27.6	110	35.3
Nonverbal information (NVI)														
NVI1	5	1.6	38	12.2	0	0	4	1.3	13	4.2	76	24.4	176	56.4
NVI2	2	0.6	4	1.3	0	0	7	2.2	8	2.6	97	31.1	194	62.2
NVI3	7	2.2	50	16.0	2	0.6	7	2.2	10	3.2	83	26.6	153	49.0
NVI4	7	2.2	37	11.9	2	0.6	7	2.2	12	3.8	86	27.6	161	51.6
Perceived personalization (PPZ)														
PPZ1	2	0.6	8	2.6	2	0.6	8	2.6	3	1.0	88	28.2	201	64.4
PPZ2	5	1.6	44	14.1	2	0.6	8	2.6	7	2.2	71	22.8	175	56.1
PPZ3	5	1.6	44	14.1	2	0.6	9	2.9	16	5.1	71	22.8	165	52.9
PPZ4	2	0.6	4	1.3	0	0	7	0	0	2.2	94	30.1	193	61.9
Mobile phone usability (MPU)														
MPU1	1	0.3	2	0.6	4	1.3	2	0.6	15	4.8	97	31.1	191	61.2
MPU2	0	0	4	1.3	0	0	4	1.3	13	4.2	96	30.8	195	62.5
MPU3	0	0	2	0.6	2	0.6	6	1.9	11	3.5	95	30.4	196	62.8
MPU4	0	0	2	0.6	0	0	4	1.3	15	4.8	90	28.8	201	64.4
MPU5	0	0	2	0.6	0	0	6	1.9	10	3.2	92	29.5	202	64.7
Mobile marketing acceptance (MMA)														
MMA1	4	1.3	27	8.7	0	0	4	1.3	30	9.6	84	26.9	163	52.2
MMA2	2	0.6	62	19.9	2	0.6	4	1.3	28	9.0	81	26.0	133	42.6
MMA3	3	1.0	39	12.5	4	1.3	4	1.3	22	7.1	94	30.1	146	46.8

The descriptive statistical analysis on the above table are explained further in detail below

The results below indicate that about 89.8% of the respondents agree that they can move through their mobile phone menu efficiently.

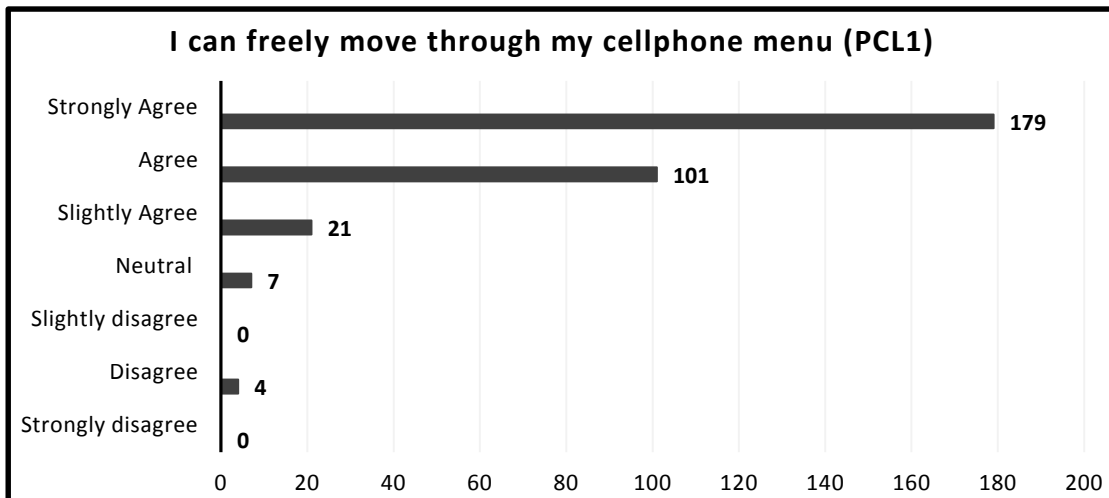

Figure 4.2.2a: PCL1

283 (90.7%) of the respondents on the figure below agree that they can control their mobile phones efficiently

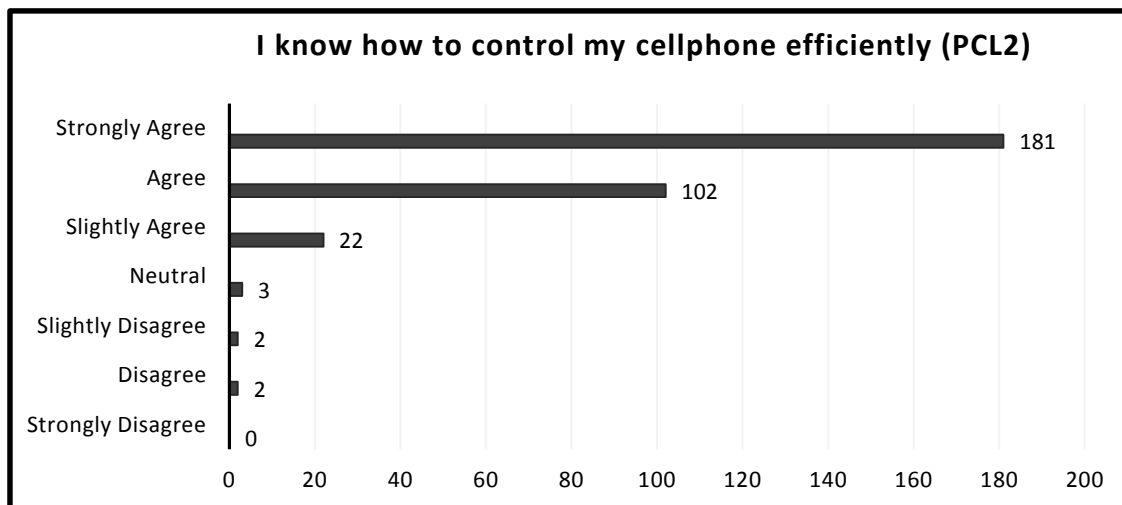

Figure 4.2.2b: PCL2

278 (89.1%) of the respondents agree that they are able to manage their mobile phone as they wish.

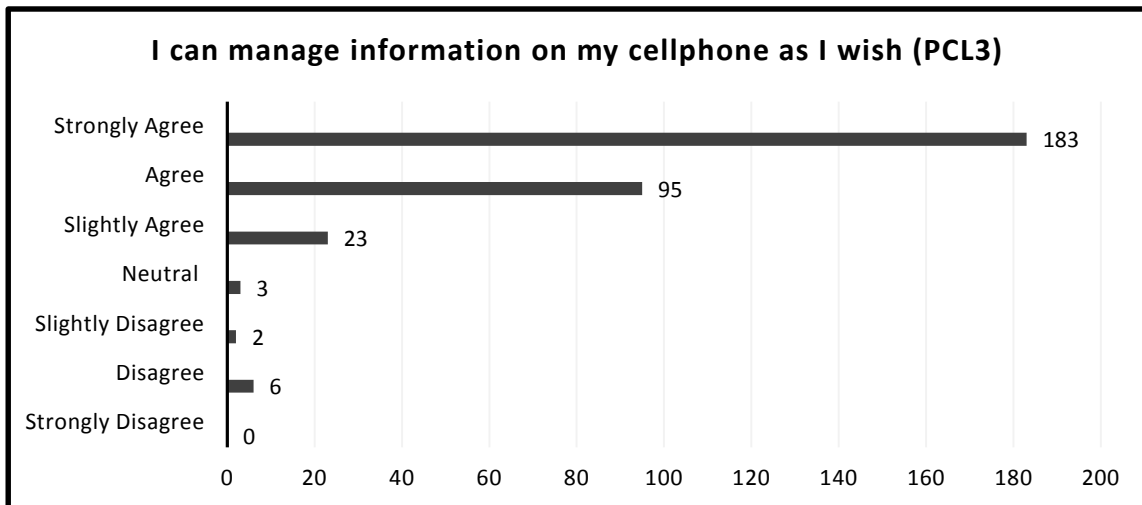

Figure 4.2.2c: PCL3

From the results below, approximately 89.1% of the respondents agree that they are able to control their mobile phones well.

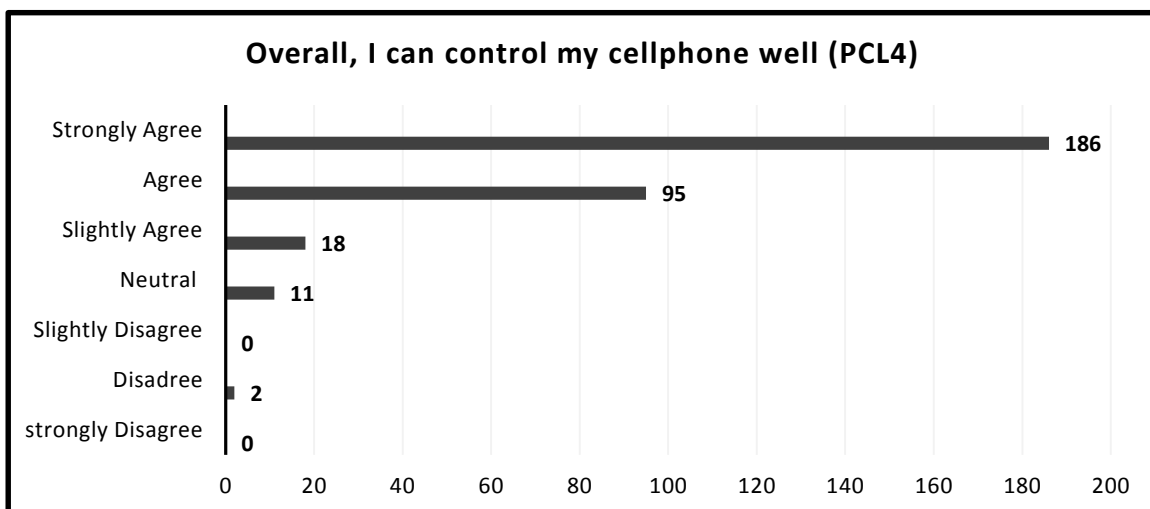

Figure 4.2.2d: PCL4

90% of the respondents agree that their mobile phones respond to their textual and numeric input.

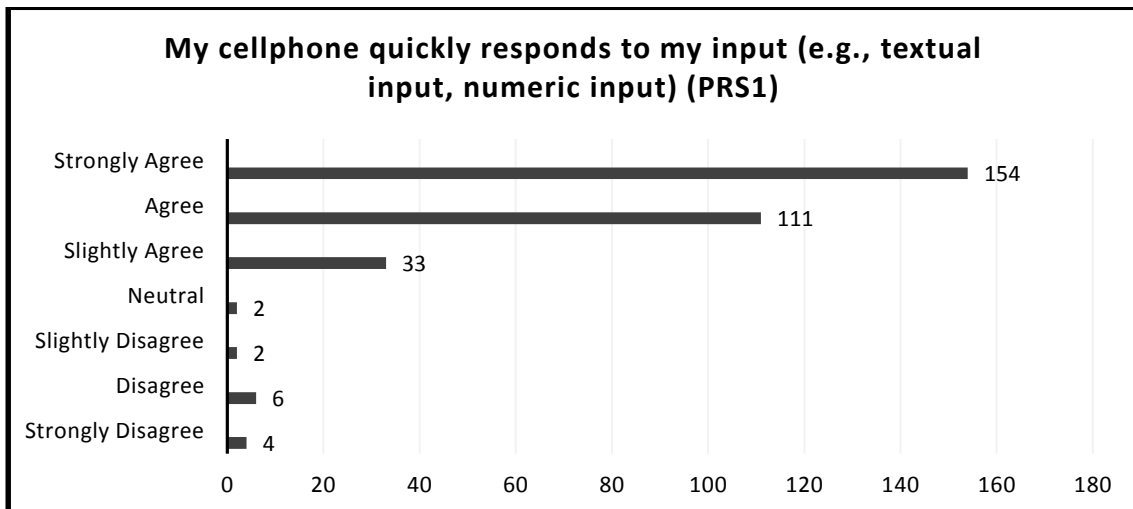

Figure 4.2.2e: PCL4

95.6% of the respondents agree and strongly agree that their mobile phones give relevant information with respect to their input.

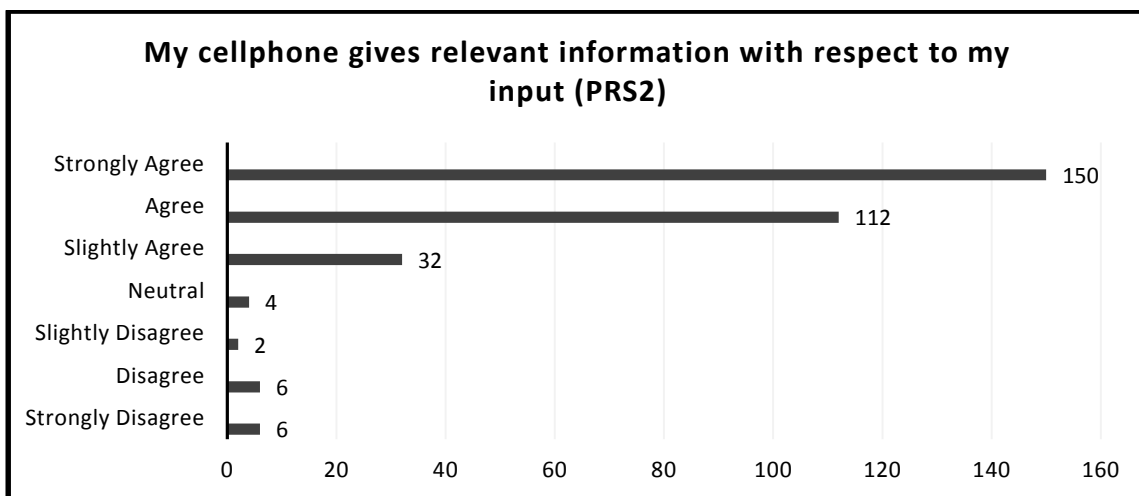

Figure 4.2.2f: PRS2

The distribution of responses below is much wider from strongly agree, agree and slightly agree which constitutes about 92.4% of the respondents that mainly agree that their mobile phones have no delay in operations when it comes to the time it takes to load information.

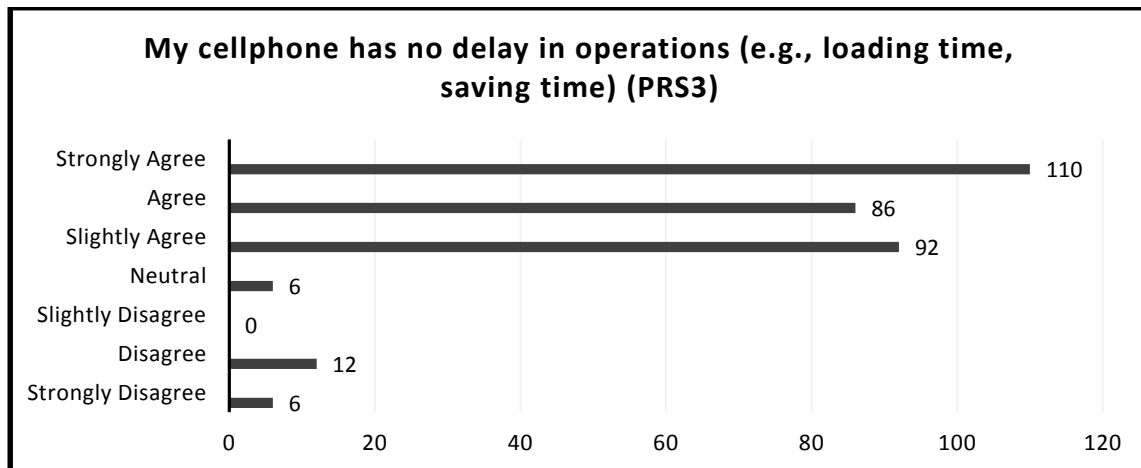

Figure 4.2.2g: PRS2

About 80.8% of the respondents agree and strongly agree that their mobile phones provide interactive interface by using images, moving pictures and icons. However, 12.2% of the respondents disagree with this statement.

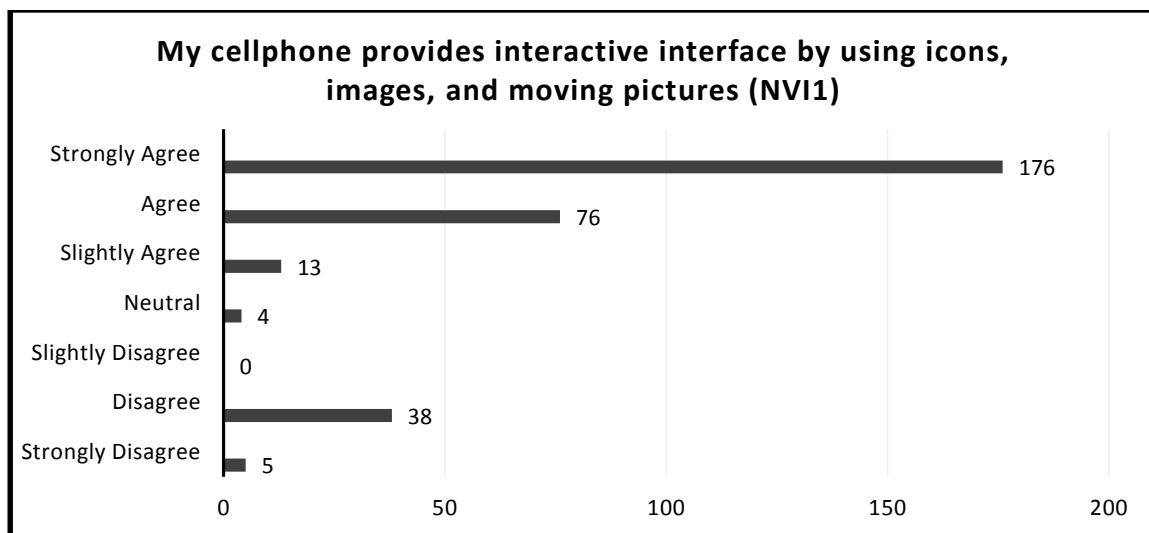

Figure 4.2.2h: NVI1

Respondents who agree and strongly agree constitute about 93.3%. The respondents confirmed that their mobile phones provide suitable tactile and auditory feedback.

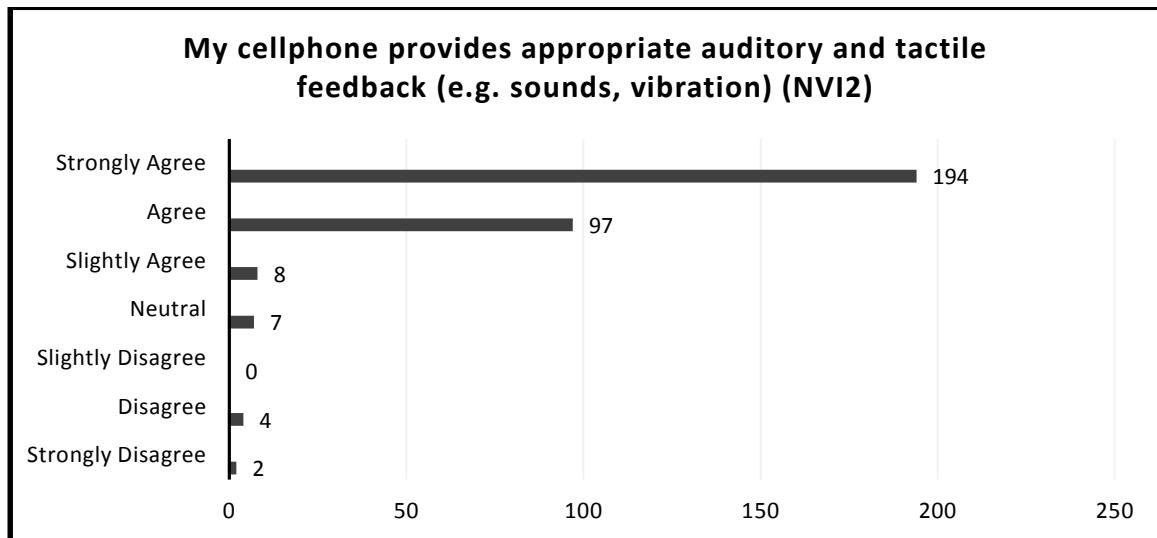

Figure 4.2.2i: NVI2

The results below indicate that the majority (75.6%) of the respondents agree and strongly agree that their mobile phone provides auditory and tactile input, for example, touch screen and voice recognition. However, about 50 of the respondents out of the 312 disagree with this statement.

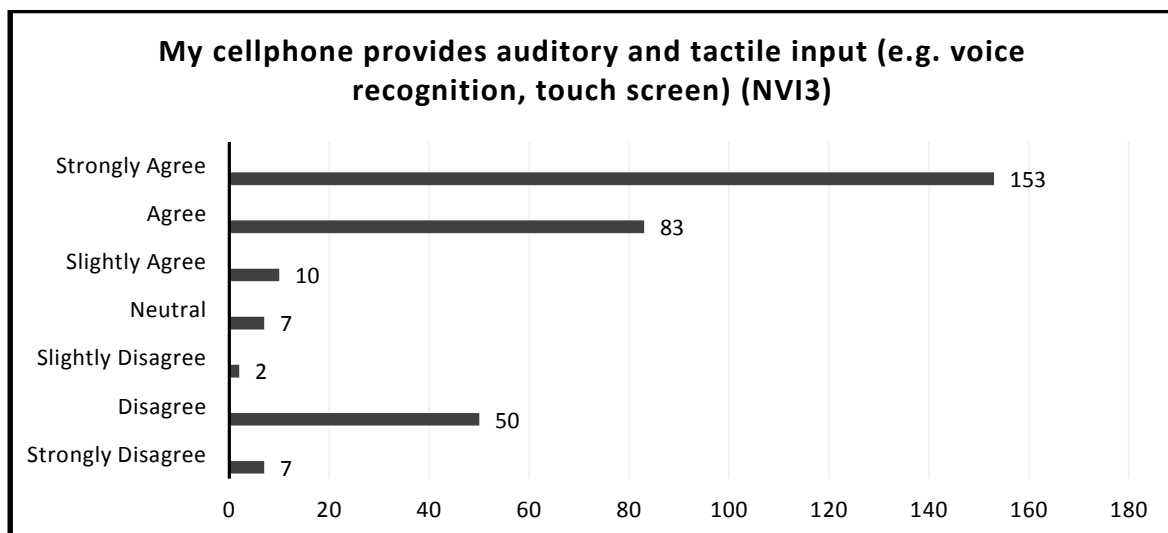

Figure 4.2.2j: NVI3

79.2% of the respondents agree that their mobile phones provide images and intuitive icons and 11.9% disagree with this statement.

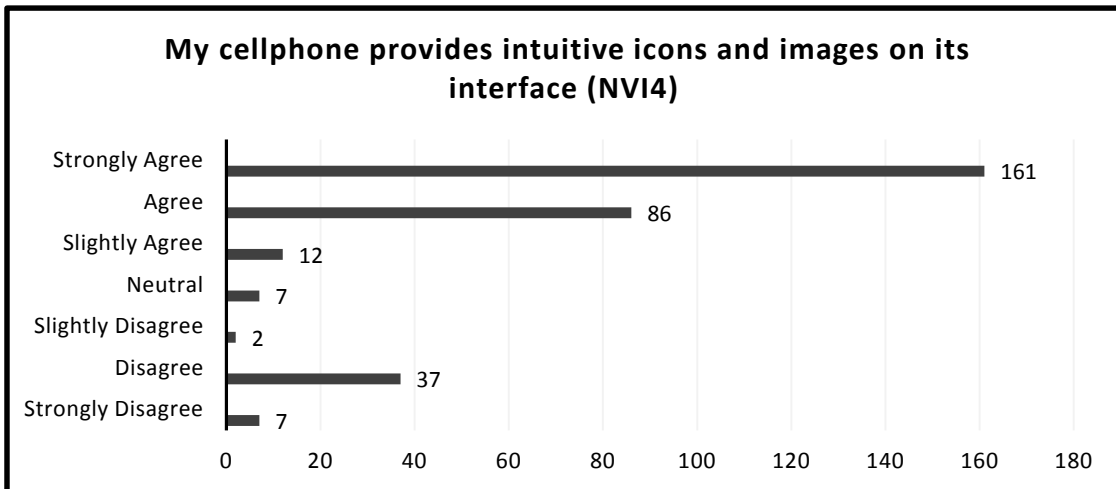

Figure 4.2.2k: NVI4

289 respondents out of the 312 agree and strongly agree that their mobile phones' ringtone can be personalised to their preference, which constitutes about 92.6%.

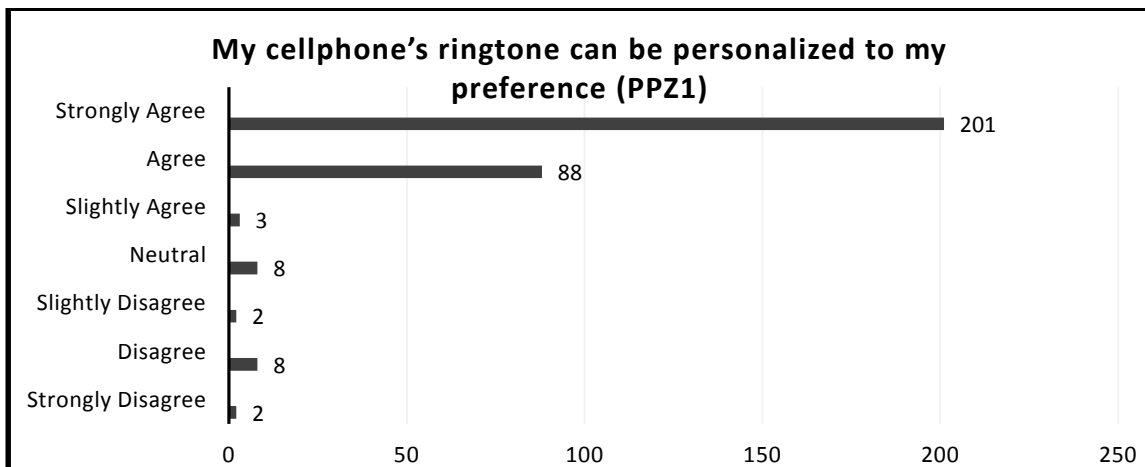

Figure 4.2.2l: PPZ1

246 (78.9%) respondents agree and strongly agree that their mobile phones' background picture can be personalised to their preference. 44 out of the 312 respondents disagree with this statement.

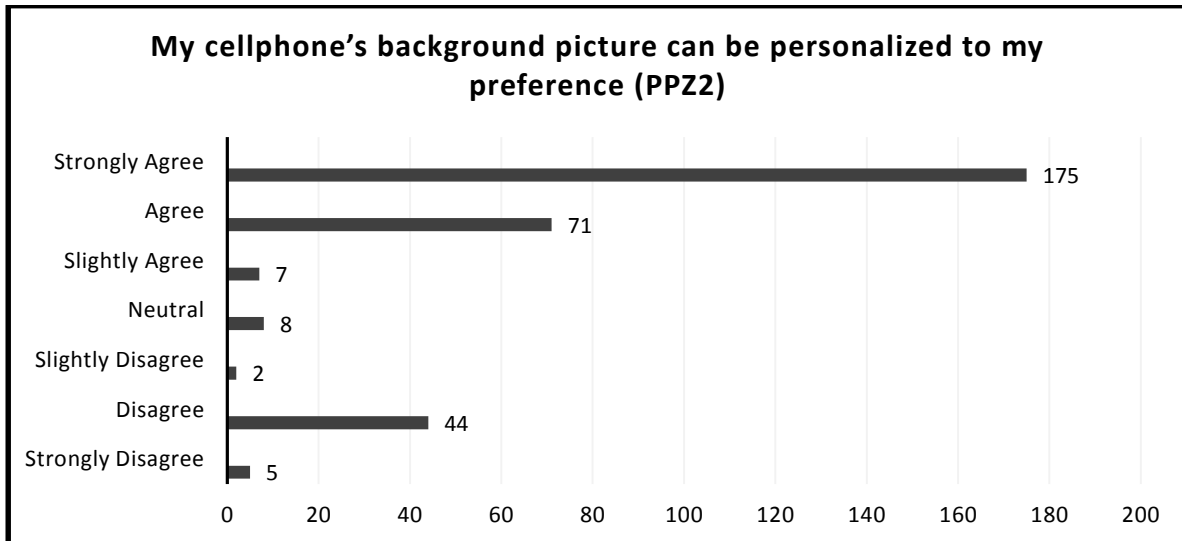

Figure 4.2.2m: PPZ2

The majority of the respondents constituting about 75.7% agree and strongly agree that their mobile phones' menu can be personalised to their preference. About 14.1% of the respondents disagree with the statement.

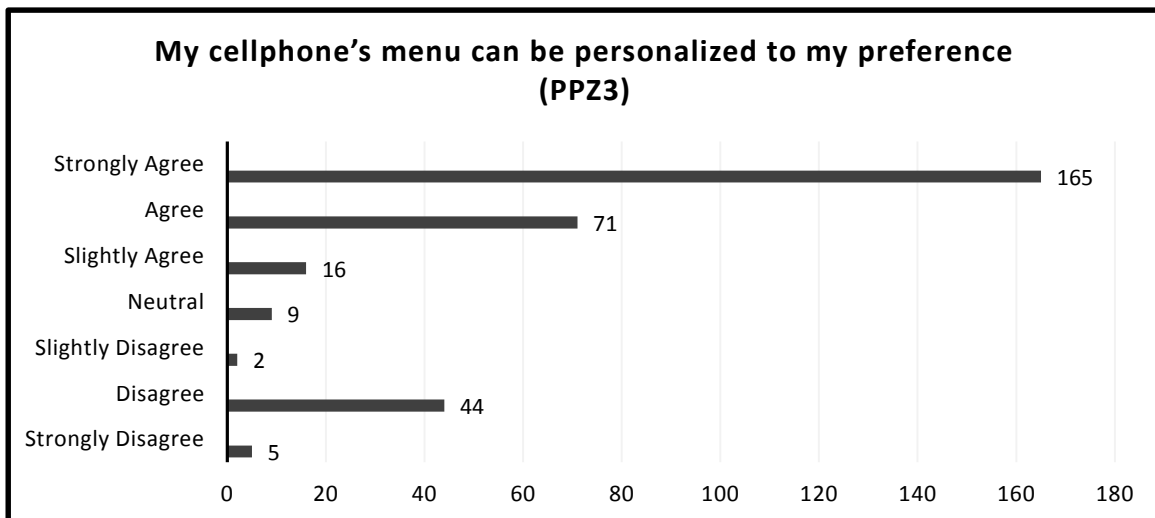

Figure 4.2.2m: PPZ3

Most of the respondents (92%) agree that they can tune their mobile phones for their personal use.

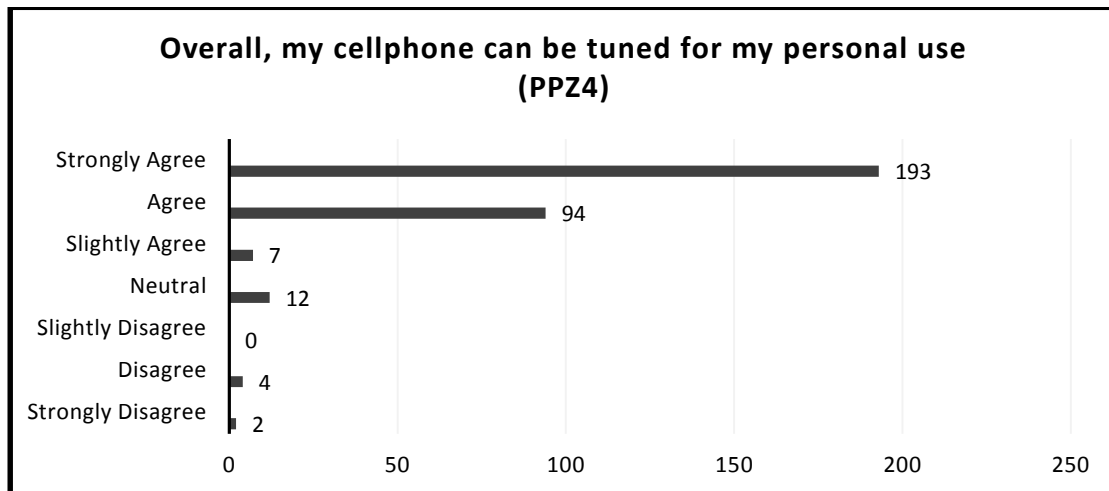

Figure 4.2.2n: PPZ4

Overall, about 92.3% of the respondents agree that they can easily understand the overall interface of their mobile phones.

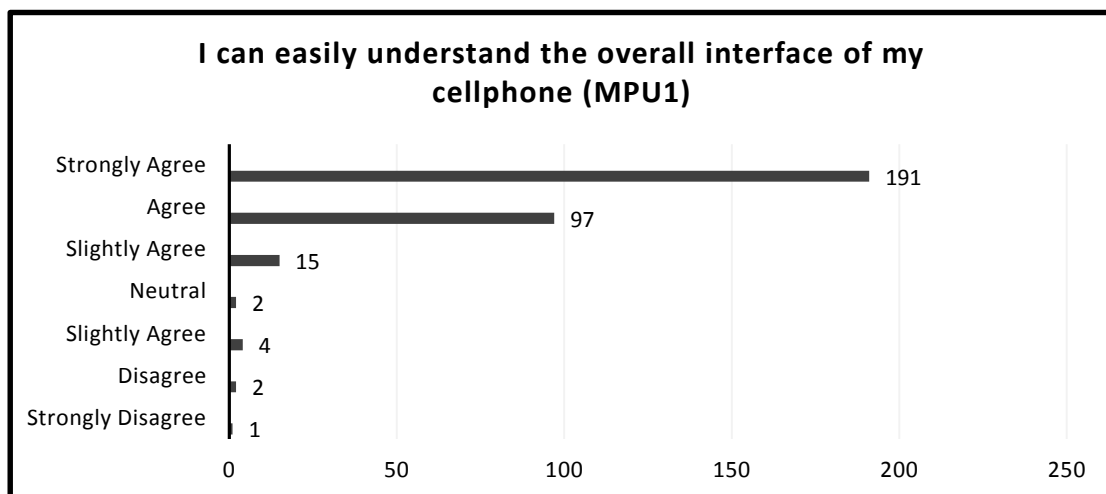

Figure 4.2.2o: MPU1

93.3% of the respondents below find it is easy to learn how to use their mobile phones.

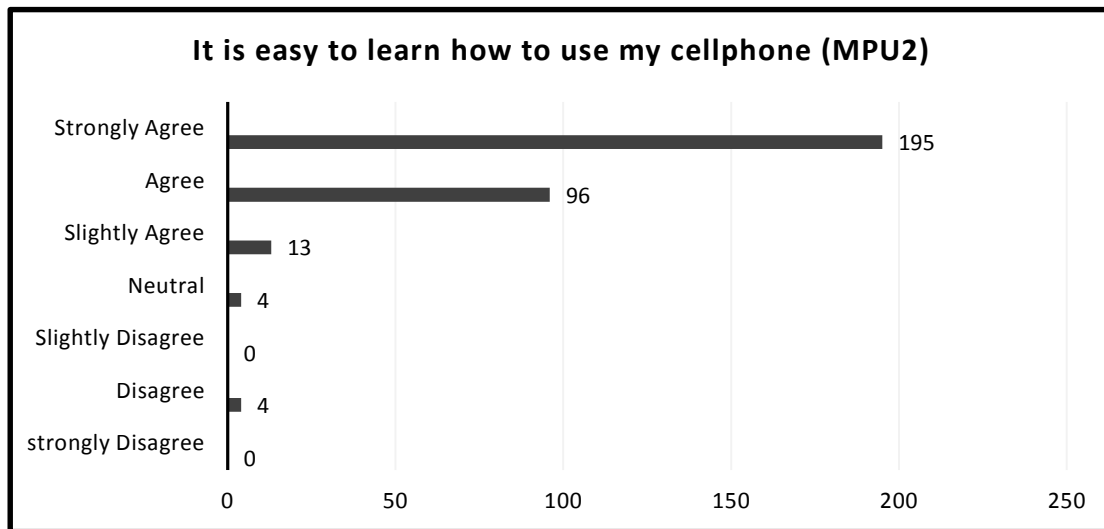

Figure 4.2.2p: MPU2

Respondents who agree and strongly agree constitute approximately 93.2%, suggesting that the informal hair-care entrepreneurs can easily and quickly find what they are looking for in their mobile phones.

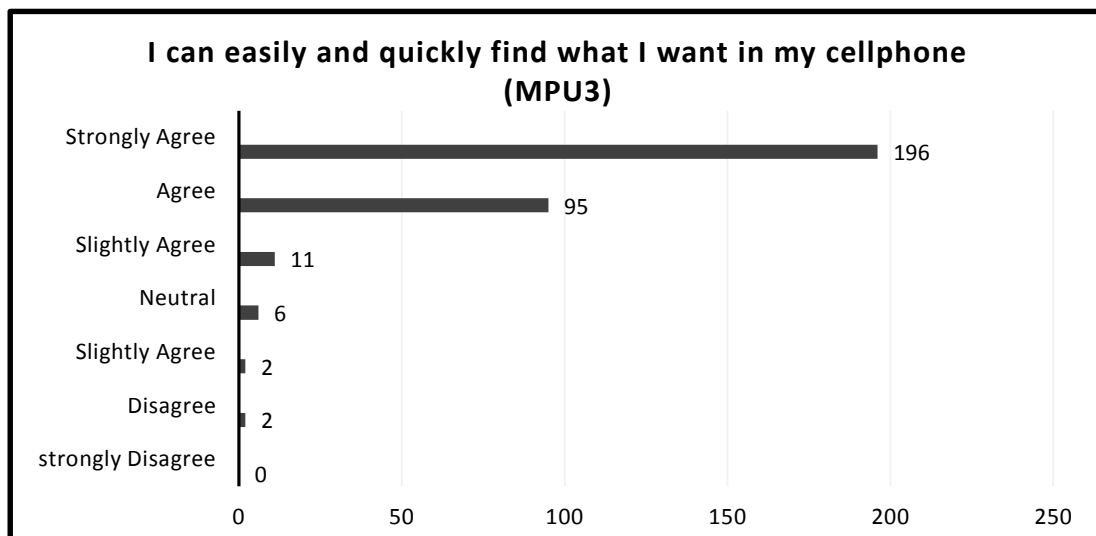

Figure 4.2.2q: MPU3

The majority (93.2%) of the respondents agree and strongly agree that it is easy to use their mobile phones.

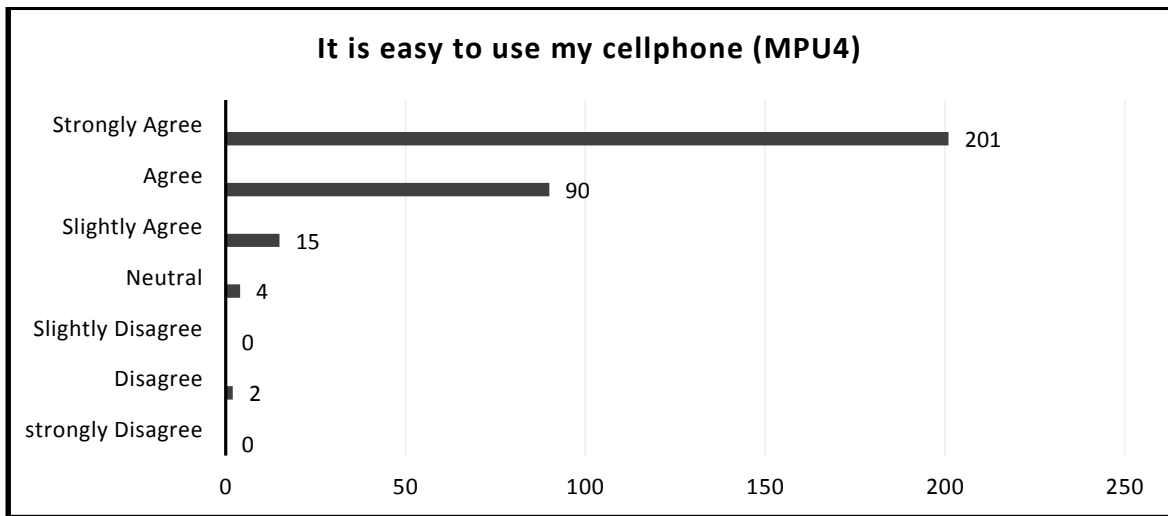

Figure 4.2.2r: MPU4

Most of the respondents (94.2%) agree and strongly agree that it is easy to remember how to use their mobile phones.

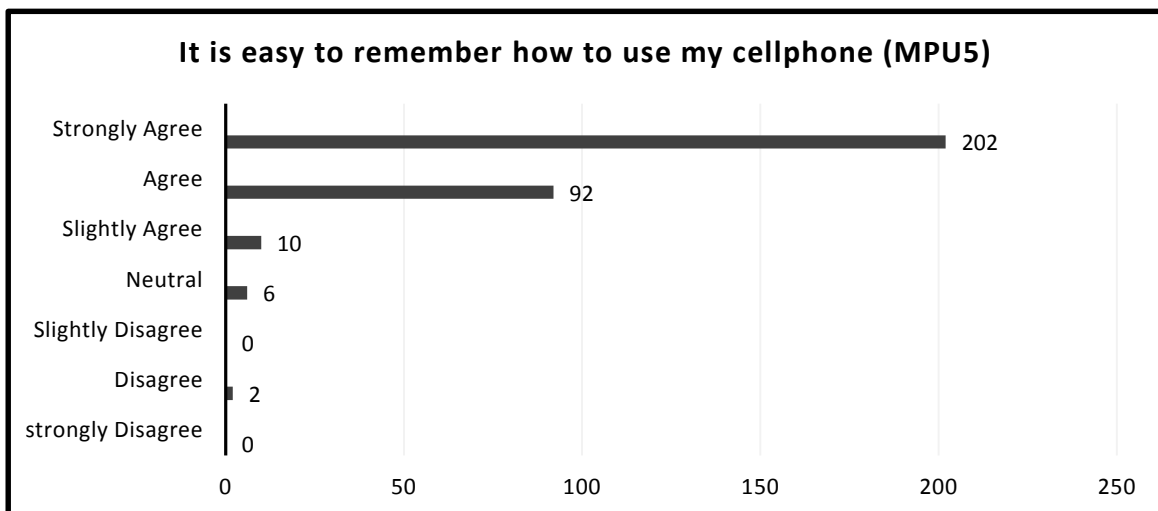

Figure 4.2.2s: MPU4

The majority (88.7%) of the respondents' responses range between slightly to strongly agree, confirming that the respondents are willing to send or share information with their customers concerning hair-care products.

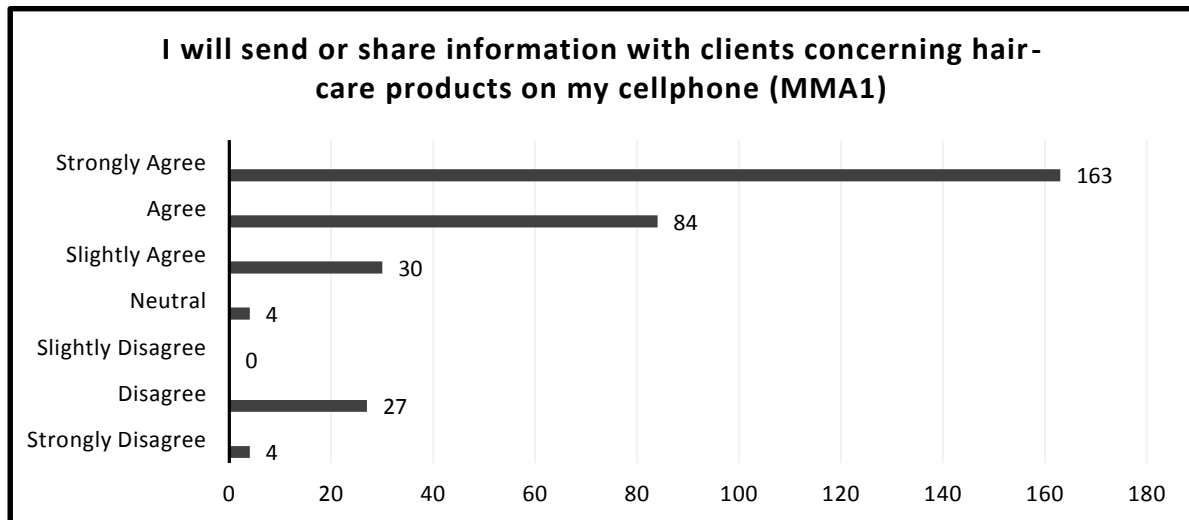

Figure 4.2.2t: MMA1

77.6% responses from the respondents ranging between slightly to strongly agree confirm that the participants agree that they will send out promotions and discounts concerning hair-care products to their customers using their mobile phones.

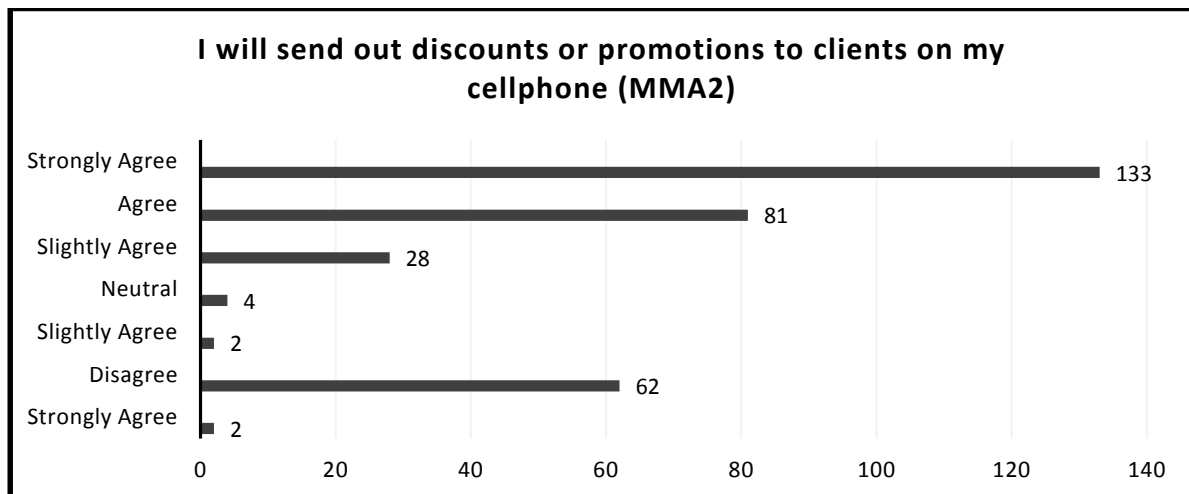

Figure 4.2.2u: MMA2

A relatively high percentage (84%) of the responses agree with the statement regarding sending requests to customers who gave them permission to do so. In hindsight, 39 out of the 312 respondents disagree with this statement.

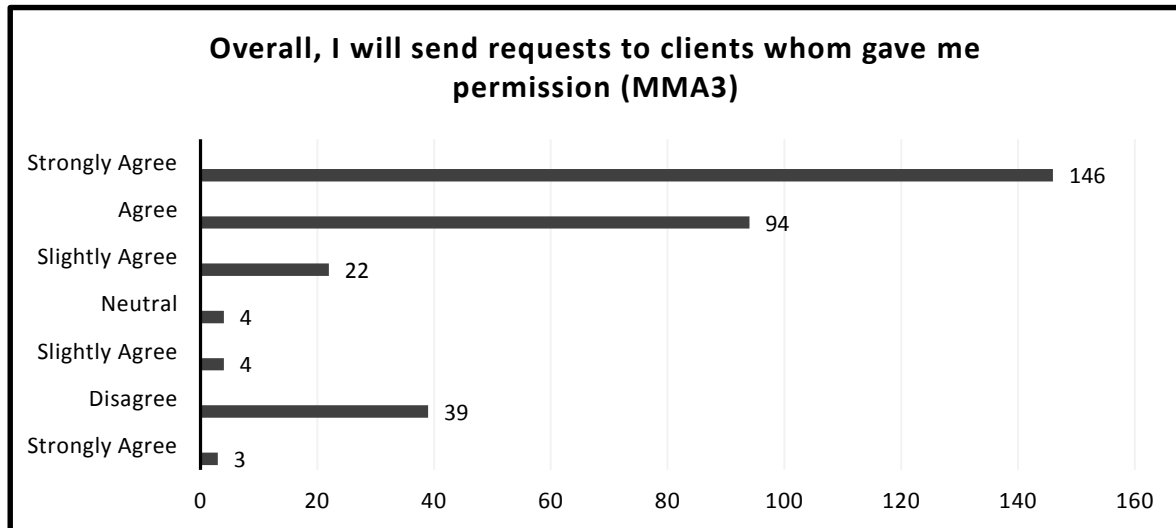

Figure 4.2.2v: MMA3

4.3 Reliability and validity assessment of the research constructs

The table below gives a presentation of the reliability and validity tests for each research construct measurement items.

Table 5: Summary of the reliability and validity test

Research constructs		Item Statistics		Cronbach's Alpha	Composite Reliability (CR)	Factor Loadings	Item-to-total correlation value	Average Variance Extracted (AVE)
		Mean Value	Standard Deviation					
Perceived Control (PCL)	PCL1	6.41	0.88	0.924	0.950	0.745	0.759	0.745
	PCL2	6.45	0.81			0.929	0.899	
	PCL3	6.40	0.95			0.960	0.891	
	PCL4	6.44	0.84			0.991	0.951	
Perceived Responsiveness (PRS)	PRS1	6.21	1.126	0.864	0.878	0.927	0.825	0.600
	PRS2	6.16	1.208			0.883	0.760	
	PRS2	5.77	1.332			0.699	0.657	
Nonverbal Information (NVI)	NVI1	5.93	1.735	0.914	0.922	0.929	0.846	0.700
	NVI3	5.64	1.918			0.783	0.751	
	NVI4	5.83	1.772			0.961	0.892	
Perceived Personalisation (PPZ)	PPZ2	5.82	1.839	0.736	0.749	0.883	0.582	0.500
	PPZ3	5.76	1.833			0.656	0.582	
Mobile Phone Usability (MPU)	MPU1	6.47	0.874	0.945	0.946	0.897	0.839	0.668
	MPU2	6.51	0.818			0.840	0.845	
	MPU3	6.51	0.802			0.826	0.824	
	MPU4	6.54	0.742			0.894	0.893	
	MPU5	6.55	0.746			0.951	0.861	
Mobile Marketing Acceptance (MMA)	MMA1	5.99	1.544	0.773	0.782	0.693	0.576	0.612
	MMA2	5.46	1.921			0.733	0.615	
	MMA3	5.79	1.705			0.789	0.650	

4.3.1 Mean value

The mean value is as indication or example of a specific centrality statistics (Lee, 2015). As presented in Table 5, the mean value, which is the reflection of the average perceptions of respondents, indicates that the most representative response on the construct across the whole sample is between 5 and 6.

4.3.2 *Standard deviation*

A standard deviation is a measure that is utilised to assess the spread of data away from an average (Lee, 2015). As shown in Table 5, respondents' responses range from 0.7 to 1.9, signifying that there is variance.

4.4 **Assessment of measurement instruments**

Zait and Berteau (2011) propose that it is imperative to apply different methods or approaches in conducting measurement of instruments in order to assure that the instrument presents reliability and validity. Reliability and validity are two fundamental components in the assessment of a measurement instrument (Tavakol & Dennick, 2011).

4.4.1 *Reliability measurements*

Reliability assessment is used to test the quality of a measurement procedure in terms of providing accuracy and repeatability (Field, 2005). The coefficients for reliability measures range from (0.00 – 1.00), with a higher coefficient demonstrating higher levels of reliability (Field, 2005). The major types of coefficients include the Cronbach's Alpha value and the Composite Reliability (CR) value.

a) Cronbach's Alpha

The Cronbach's Alpha measures internal consistency of a scale or test; it is expressed as a coefficient that ranges between (0 – 1) (Tavakol & Dennick, 2011). Internal consistency explains the degree to which all the items in a test assess the same variable and thus it is associated to the inter-relatedness of the items within the assessment or test (Tavakol & Dennick, 2011). It is imperative that the internal consistency is determined prior to the test employed for research purposes in order to ensure validity (Tavakol & Dennick, 2011). A coefficient of more than 0.7 for the Cronbach's Alpha is generally considered acceptable (Zait & Berteau, 2011). As outlined in Table 5, the Cronbach's Alpha value ranges between (0.736 – 0.945) which meets and exceeds the adequate threshold, therefore signifying internal consistency.

b) Composite Reliability (CR)

In order to further test for internal reliability, a Composite Reliability (CR) assessment had to be conducted. According to Geldhof, Preacher and Zyphur (2014), Composite reliability (CR) as calculated from factor loadings yields more precise estimates of reliability than those provided by the Cronbach's Alpha. Composite reliability as discussed by several scholars (i.e., Bentler, 2007; McDonald, 1970; Raykov, 1997; Werts, 1974) is theoretically similar to the Cronbach's Alpha in the sense that it represents the ratio of an item's projected true score variance in relation to its total variance.

Unlike the Cronbach's Alpha, however, the Composite Reliability (CR) acknowledges the possibility of varied item-construct relations and projects true score variance as a function of the factor loadings (Geldhof et al., 2014). Assuming a congeneric measure with a standardized latent variable t (i.e. with variance fixed to 1), Composite reliability (CR) can be estimated using the following formula (Geldhof et al., 2014):

$$CR_{\eta} = \frac{\sum(\lambda_{\gamma i})^2}{[\sum(\lambda_{\gamma i})^2 + \sum \epsilon_i]}$$

Where λ represents the factor loading of item i into a single common factor and ϵ represents the unique variance of item i (Geldhof et al., 2014). A composite reliability value that exceeds 0.7 indicates the existence of internal reliability (Chinomona, Masinge & Sandada, 2014). As presented in Table 5, the results for Composite Reliability (CR) have yielded a point estimate that ranges between 0.749–0.950, which consequently, validates that there is internal consistency for all research variables measured.

4.4.2 Validity measurements

As stated by Bagozzi and Yi (2012) validity methods were developed to study the extent of convergence for a set of measurements of hypothesised variables and of discrimination amongst those measures and measurements of different variables. Consequently, to measure construct validly, two methods were used, namely, convergent and discriminant validity. The notion is that a reasonable sense of the

construct validity indicators is obtained when the measurements converge in an appropriate way and yet do not relate too strongly or highly with the measurements of something else (Bagozzi & Yi, 2012).

a) Convergent validity

Convergent validity measures the correlations between measurements of the same variable measured by different methods (Guo, Aveyard, Fielding & Sutton, 2008; Raykov, 2011). In order to assess convergent validity, two methods were utilised, namely, factor-loadings and Item-total correlation.

I. Factor-loadings

When interpreting the factors, it is imperative that a researcher looks at the loadings in order for the strength of the relationship to be determined (Yong & Pearce, 2013). Factors can be recognised by the biggest loadings, but it is also crucial to investigate the zero and low loadings in order to allow for the identification of the factors to be confirmed (Yong & Pearce, 2013). According to Chinomona, Masinge and Sandada (2014), the recommended benchmark for the factor loadings should be above 0.5. As noted in Table 5, the factor loadings range between 0.656 – 0.991 which indicates a strong loading of the instrument on the variables. This implies that all factors converged well on the variables they were intended to measure, thus, affirming that convergent validity indeed exists.

II. Item-to-total correlation value

Item-total correlation are associations amongst each factor and the total score from the survey questionnaire (Field, 2005). In a reliable scale, as suggested by Field (2005), all items have to correlate with the total. Chinomona and Dhurup (2014) suggest that the acceptable threshold for the item-to-total values should not be lower than 0.5 and if any of these values were less than 0.5, this would mean that a specific item does not correlate as anticipated with the overall scale (Field, 2005). It is recommended that Items with low correlations be dropped (Field, 2005). As indicated in Table 5, all item-to-total values for all the research variables were above the

proposed threshold of 0.5, signifying that the measurements instruments converged as estimated on the variable they were intended to measure.

b) Discriminant validity

Discriminant validity refers to the uniqueness of different variables (Guo et al., 2008). Zait and Berteau (2011) assert that discriminant validity assumes that the measurement items must relate higher amongst them than they relate with other measurement items from other variables that are not supposed to correlate theoretically. Testing for discriminant validity was conducted using two methods, namely, Average Variance Extracted (AVE) and Inter-Construct Correlation Matrix which is discussed in detail below.

III. Average Variance Extracted (AVE)

Zait and Berteau (2011) suggests that, in order for discriminant validity to be established, there is a need to perform a suitable AVE (Average Variance Extracted) analysis. An Average Variance Extracted (AVE) analysis is used to test whether the square root of every Average Variance Extracted (AVE) value belonging to each latent variable is much higher than any correlation amongst any pair of latent variables (Zait & Berteau, 2011).

According to Fornell and Larcker (1981), the Average Variance Extracted (AVE) is used to measure the quantity of variance that is captured by a variable. Therefore, it is used to determine whether the measurement items of the variable explain more variance than the measurement items of the other variables do (Zait & Berteau, 2011). The Average Variance Extracted (AVE) was calculated using the following formula:

$$V_{\eta} = \sum \lambda \gamma_i^2 / (\sum \lambda \gamma_i^2 + \sum \epsilon_i)$$

Where λ_i is the factor loading of each measurement item on its corresponding variable and ϵ_i is the error variance or measurement (Zait & Berteau, 2011).

The rule as proclaimed by Zait and Berteau (2011) says that the square root of the Average Variance Extracted (AVE) of each variable must be much greater than the correlation of the specific variable with any of the other variables. Thus, the accepted threshold of Average Variance Extracted (AVE) for each variable should be at least 0.50 (Fornell & Larcker, 1981). As noted in Table 5, the results for Average Variance Extracted (AVE) range between 0.500-0.745 which is above the recommended threshold, implying that discriminant validity exists.

IV. Inter-Construct Correlation Matrix

The correlation matrix in table 6 illustrates the examination of discriminant validity. Scholars (Bagozzi & Yi, 2012) have suggested that when a correlation is too high amongst two or multiple constructs, it customarily mean that the relationship is strong, whereas a very low correlation implies that the relationship between constructs is weak.

Table 6: Inter-Construct Correlation Matrix

Research Constructs		PCL	PRS	NVI	PPZ	MPU	MMA
PCL	Pearson Correlation Sig. (2-tailed)	1.000					
PRS	Pearson Correlation Sig. (2-tailed)	0.505 **	1.000				
NVI	Pearson Correlation Sig. (2-tailed)	0.233 **	0.191 **	1.000			
PPZ	Pearson Correlation Sig. (2-tailed)	0.303 **	0.307 **	0.744 **	1.000		
MPU	Pearson Correlation Sig. (2-tailed)	0.688 **	0.586 **	0.312 **	0.370 **	1.000	
MMA	Pearson Correlation Sig. (2-tailed)	0.201 **	0.177 **	0.244 **	0.257 **	0.263 **	1.000

** Correlation is significant at the 0.01 level (2-tailed)

To measure discriminant validity, the AVE of the variable must be higher than the shared variance amongst the variables and the other model variables (Chinomona, Masinge & Sandada, 2014). Table 6 lists the correlation matrix with correlation between variables and diagonally is the square root AVE. As presented in Table 6, the diagonal coefficients are greater than the ones below the diagonal.

Moreover, as endorsed by Grace (2006), using numerical indicators to determine the strength of a relation between constructs in an investigation helps to quantify whether there is a negative or positive relationship. Statistically, the coefficients used to measure this relationship range between -1 and +1, where, -1 denotes a negative or insignificant relationship and +1 denoting a positive or significant relationship (Grace, 2006). Thus, the inter-construct correlation matrix values for this research as stipulated in Table 6 acclaim that there is discriminant validity as all the coefficients are below 1 meaning that the research constructs are all unique from each other, confirming that indeed discriminant validity exists.

4.5 Confirmatory Factor Analysis (CFA)

4.5.1 CFA model

The Confirmatory Factor Analysis (CFA) was performed using the Analysis of Moment Structures (AMOS) statistical software version 22 in order to approximate the underlying relation amongst the independent variables on the dependent ones (Bagozzi & Yi, 2012).

The figure below is a diagram that illustrates the hypothesised structure of the Confirmatory Factor Analysis (CFA) model. Confirmatory Factor Analysis (CFA), therefore, examines the fit of latent constructs underlying manifest items (Lee, 2015). The oval shape represents the latent constructs (unmeasured construct) whilst the rectangular shapes signify the manifest, also known as the observed variables (Suhr, 2006). In line with the manifest items are error terms, which are also represented by circular or oval shapes (Suhr, 2006). The bidirectional arrows signify the relationship between the latent constructs (Suhr, 2006).

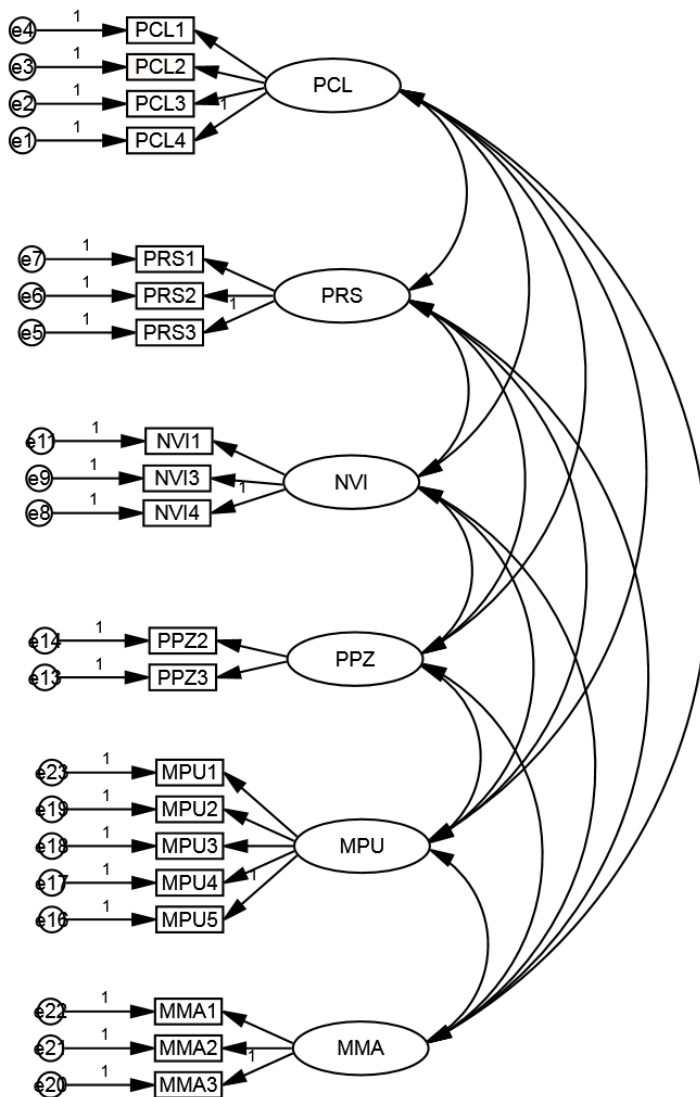

Figure 3: CFA Model

*** Note: PCL → Perceived control; PRS → Perceived responsiveness; NVI → Nonverbal information; PPZ → Perceived personalisation; MPU → Mobile phone usability; MMA → Mobile marketing acceptance**

It is important to note that after the Confirmatory Factor Analysis (CFA) model was run, there were three measurement items that were eliminated and the reason being that these items' factor loadings were below the satisfactory threshold of 0.5 as recommended by Chinomona et al. (2014). The purpose of this exclusion was to improve the model fit. After eradicating the measurement items that had low factor loadings (< 0.5), the residual items converged satisfactorily. Hooper et al. (2008)

suggest that the measurement items with a low multiple should be eliminated from the analysis as it serves as an indication that there is an extremely high level of error.

4.5.2 **Model fit test**

The model fit test was executed to determine how well the model fits the sample data (Hooper, Coughlan & Mullen, 2008). It is good practice to evaluate the fit of each variable and its measurement items independently in order to determine whether there are any items that are predominantly weak (Hooper et al., 2008). Therefore, to assess the fitness of the model there are measures utilised to provide the most significant indication of how well the proposed model fits the data (Hooper et al., 2008).

According to Larwin and Harvey (2012), a combination of criteria are used to assess the fit between the observed data and the hypothesised theory. In an assessment by McDonald and Ho (2002), it was discovered that the most universally reported fit indices are Composite Fit Index (CFI), Goodness of Fit Index (GFI). Additionally, Kline (2005) and Hooper (2008) advocate for the use of the Augmented Goodness of Fit Index (AGFI), Chi-square test, Random Measurement of Standard Error Approximation (RMSEA), Tucker-Lewis Index (TLI), Normed Fit Index (NFI), Relative Fit Index (RFI) and Incremental Fit Index (IFI).

Table 7 show the model fit indices and their acceptable threshold (Hooper et al., 2008; Larwin & Harvey, 2012), the model fit of the instruments was checked using Confirmatory Factor Analysis (CFA) and the following table lists the statistical indicators' results pertaining to the model fit test for this research. The model fit indices results (CFA) are addressed separately subsequently.

Table 7: Summary of the model fit indices and their acceptable threshold (CFA)

Fit Indices	Acceptable threshold	Model fit indices results (CFA)	Acceptable (√) / unacceptable (×)
Chi-square (CMIN/DF) value	< 3.000	1.560	√
Goodness of Fit Index (GFI)	≥ 0.900	0.941	√
Augmented Goodness of Fit Index (AGFI)	≥ 0.900	0.905	√

Comparative Fit Index (CFI)	≥ 0.900	0.988	√
Incremental Fit Index (IFI)	≥ 0.900	0.988	√
Normed Fit Index (NFI)	≥ 0.900	0.967	√
Relative Fit Index (RFI)	≥ 0.900	0.952	√
Tucker-Lewis Index (TLI)	≥ 0.900	0.982	√
Random Measurement of Standard Error Approximation (RMSEA)	< 0.080	0.042	√

It is important to note that in order to improve the model fit, it was indicated in AMOS (modification indices) that the model fit could be improved by allowing correlations amongst factors. By correlating factors, as suggested by Suhr (2006), it can be simply argued that these factors are actually testing and measuring the same thing.

a) Chi-square (CMIN/DF) value

The chi-square test points out the amount of variance amongst observed and expected covariance matrices (Suhr, 2006). A chi-square value that is closer to zero demonstrates that there is little variance among the observed and expected covariance matrices (Suhr, 2006). According to Hooper (2008), there is no agreement concerning an adequate ratio for the chi-square, suggestions range from as low as 2.0 (Tabachnick & Fidell, 2007) and high as 5.0 (Wheaton, Alwin & Summers, 1977). As shown in Table 7, the chi-square value (1.560) is below the recommended threshold of 2.0 or 5.0, indicating a good model fit.

b) Goodness of Fit Index (GFI)

According to Hooper (2008), the Goodness of Fit Index (GFI) was developed as an alternate to the chi-square assessment and computes the amount of variance that is accounted for by the projected population covariance (Tabachnick & Fidell, 2007). By closely examining the covariances and variances accounted for by the model, it indicates how closely the model manages to duplicate the observed covariance matrix (Diamantopoulos & Siguaw, 2000). The Goodness of Fit Index (GFI) value ranges from 0 – 1, with greater samples enlarging its value (Hooper, 2008). Traditionally, the recommended benchmark for Goodness of Fit Index (GFI) is 0.900 (Hooper, 2008).

As observed in Table 7, the Goodness of Fit Index (GFI) value for the study is 0.941, which is above the stipulated threshold, thus signifying the goodness of fit.

c) *Augmented Goodness of Fit Index (AGFI)*

The Augmented Goodness of Fit Index (AGFI) adjusts the Goodness of Fit Index (GFI) based upon degrees of freedom, with additional saturated models decreasing the fit (Hooper, 2008). Additionally, Augmented Goodness of Fit Index (AGFI) tends to escalate with sample size, as the Goodness of Fit Index (GFI), the values for Augmented Goodness of Fit Index (AGFI) also range from 0 – 1, with the generally acceptable value of 0.900 or greater. Table 7 shows that the Augmented Goodness of Fit Index (AGFI) value is 0.905 which is above the proposed benchmark, indicating the good fit of the model.

d) *Comparative Fit Index (CFI)*

The Comparative Fit Index (CFI) is equivalent to the inconsistency function adjusted for sample size (Suhr, 2006). Comparative Fit Index (CFI) ranges between 0 - 1 with a higher value representing better model fit (Suhr, 2006). A satisfactory model fit is indicated by a Comparative Fit Index (CFI) value of 0.90 or greater (Suhr, 2006). As presented in Table 7, the Comparative Fit Index (CFI) value is 0.988 which exceeds the required benchmark, indicating that there is a good fit.

e) *Incremental Fit Index (IFI)*

It is considered that an Incremental Fix Index (IFI) value that is 0.900 or greater signifies an acceptable fit (Hooper, 2008). The study's Incremental Fix Index (IFI) value 0.988 exceeds the required threshold, implying acceptable fit.

f) *Normed Fit Index (NFI)*

The Normed Fix Index (NFI) evaluates fit comparative to a baseline model that undertakes no covariances amongst the observed constructs (Hooper, 2008). The recommended threshold for the Normed Fix Index (NFI) is 0.900 or greater (Hooper,

2008). As noted in Table 7, the value for Normed Fit Index (NFI) is 0.967 and exceeds the suggested threshold, consequently indicating a good fit.

g) *Relative Fit Index (RFI)*

The recommended value for the Relative Fit Index (RFI) is 0.900 (Hooper, 2008). As indicated in Table 7, the Relative Fit Index (RFI) is above the acceptable value 0.952, thus signifying an acceptable model fit.

h) *Tucker-Lewis Index (TLI)*

The suggested threshold for the Tucker-Lewis Index (TLI) is 0.900 (Hooper, 2008). The value of the Tucker-Lewis Index (TLI) as noted in Table 7 at 0.982 is above the proposed benchmark, which is an indication of a good fit

i) *Random Measurement of Standard Error Approximation (RMSEA)*

Root Mean Square Error of Approximation (RMSEA) is connected to residual in the model (Suhr, 2006). Root Mean Square Error of Approximation (RMSEA) values range between 0 - 1 with a lesser Root Mean Square Error of Approximation (RMSEA) value signifying better model fit (Suhr, 2006). An adequate model fit is indicated by a Root Mean Square Error of Approximation (RMSEA) value of 0.06 or less (Suhr, 2006). As presented in Table 7, the Root Mean Square Error of Approximation (RMSEA) value is 0.042, which is below the suggested threshold, therefore implying that there is acceptable fit.

4.6 Path modelling

Path modelling was conducted to test the hypothesised relationship amongst constructs in this study. Path modelling explains the relationship between constructs and their measures. Figure 4 below depicts the structural equation model, which is similar to the CFA in that the latent constructs are represented by the oval shape, and the measurement items are signified by the rectangular shape. Adjacent to the

measurement items are error terms in a circular shape and the unidirectional arrows amongst latent constructs were used to convey the causal relationships.

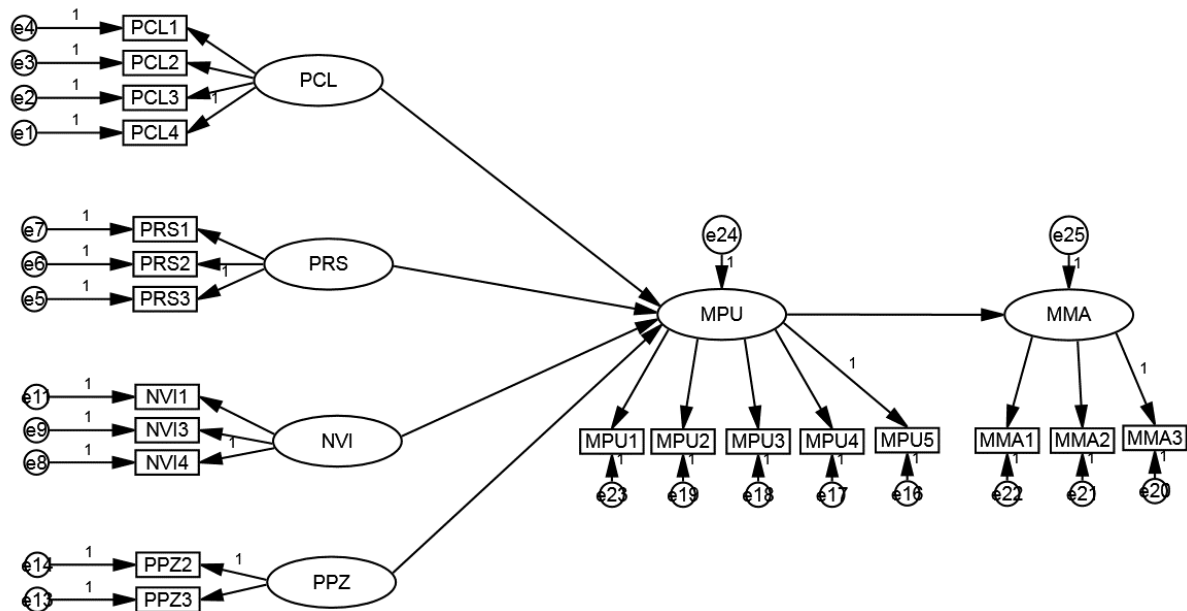

Figure 4: Path Model

4.6.1 *Model fit assessment (path model)*

The model fit indices were also inspected when assessing the model fit of the path model. The table below indicates results concerning the assessment.

Table 8: Summary of the model fit indices and their acceptable threshold (Path Model)

Fit Indices	Acceptable threshold	Model fit indices results (CFA)	Acceptable (√) / unacceptable (×)
Chi-square (CMIN/DF) value	< 3.000	1.460	√
Goodness of Fit Index (GFI)	≥ 0.900	0.943	√
Augmented Goodness of Fit Index (AGFI)	≥ 0.900	0.909	√
Composite Fit Index (CFI)	≥ 0.900	0.990	√
Incremental Fit Index (IFI)	≥ 0.900	0.990	√
Normed Fit Index (NFI)	≥ 0.900	0.969	√
Relative Fit Index (RFI)	≥ 0.900	0.955	√
Tucker-Lewis Index (TLI)	≥ 0.900	0.985	√
Random Measurement of Standard Error Approximation (RMSEA)	< 0.080	0.038	√

The acceptable threshold used in the model fit assessment of the CFA model apply to the path model as well. Table 8 presents the results of the structural equation model which is depicted in figure 4. The overall model fit was adequate and meets the suggested threshold. The overall model fit indices as outlined in Table 5 were Chi-square = 1.460; GFI = 0.943; AGFI = 0.909; CFI = 0.990; IFI = 0.990; NFI = 0.969; RFI = 0.955; TLI = 0.985; RMSEA = 0.038

4.7 Results for Hypothesis Testing

Hypothesis testing is a statistical procedure used by statisticians that offers an objective framework for making decisions whether to accept or reject the hypothesis (Pereira & Leslie, 2009). The hypotheses of the study were examined in order to assess the relationships between latent constructs. The table below presents the proposed hypotheses, the path coefficients, and the probability values and indicates the supported and rejected hypotheses.

Table 9: Structural Equation Model (SEM) Analysis Results

Hypothesised relationships	Hypotheses	Path Coefficients (β)	P-values	Supported / Rejected
PCL→MPU	H ₁	0.590	***	Supported and significant
PRS→MPU	H ₂	0.285	***	Supported and significant
NVI→MPU	H ₃	0.200	***	Supported and significant
PPZ→MPU	H ₄	-0.096	0.20	Not supported
MPU→MMA	H ₅	0.316	***	Supported and significant

Significant @ * = 0.10; ** = 0.05; *** = 0.01

4.7.1 Hypothesis Verification

The structural model was verified using significance of path coefficients and factor loadings to signify the strength of the relationships amongst independent and dependent constructs. Table 9 above presents the results of the AMOS analysis on the structural model alongside the path coefficients and p-values.

The support for the hypotheses of the study, as labelled by their corresponding paths in Figure 4, could be determined by investigating the directionality (negative or positive) of the path coefficients and the significance of the p-values. The recommended standardised path coefficients as suggested by Chinomona et al. (2014) are estimated to be preferably 0.3 or greater and at least 0.2. In order to review which hypotheses were supported or not supported, the statistical significance of the path coefficients were used as determinants.

a) Perceived Control (PCL) → Mobile Phone Usability (MPU)

The path coefficient for H₁ is 0.590, which suggest that there is a significant relationship between PCL and MPU, signifying a positive effect. Additionally, the p-value indicates a 0.01 (99%) level of confidence, which means that the relationship is positive and significant.

b) Perceived Responsiveness (PRS) → Mobile Phone Usability (MPU)

The path coefficient for H₂ is 0.285, suggesting that there is a relationship that exists between PRS and MPU, also indicating a positive effect. In addition, the p-value indicates a 0.01 (99%) level of confidence, which means that the relationship is significant and supported.

c) Nonverbal Information (NVI) → Mobile Phone Usability (MPU)

The path coefficient for H₃ is 0.200, signifying that there is a positive relationship between NVI and MPU as it does meet the recommended 0.2 criteria. The p-value indicates a 0.01 confidence level, which meets the suggested p<0.01 (99%), therefore indicating that the relationship is significant and positive.

d) Perceived Personalisation (PPZ) → Mobile Phone Usability (MPU)

The path coefficient of H₄ is -0.096, suggesting that there is a negative relation between PPZ and MPU. Furthermore, the p-value indicates a 0.2 level of confidence, which exceeds the recommended criteria of 0.05, which means that the relationship is negative and insignificant.

e) Mobile Phone Usability (MPU) → Mobile Marketing Acceptance (MMA)

The path coefficient of H₅ is 0.316, suggesting that there is a strong relationship between MPU and MMA, showing a positive effect. Likewise, the p-value indicates a 0.01 (99%) level of confidence, meaning that the relationship is significant and positive.

4.7.2 Conclusion regarding the Hypotheses

The results presented in Table 9 provide support for H₁, H₂, H₃, H₅, however, H₄ tested negative. Hypothesis 1 posited a significant and positive ($\beta = 0.590$; $p = 0.01$) relationship between perceived control and mobile phone usability, therefore, H₁ is supported. Hypothesis 2 also hypothesised a significant and positive ($\beta = 0.285$; $p = 0.01$) relation between perceived responsiveness and mobile phone usability, as a result H₂ is supported. The standardised coefficients of nonverbal information and mobile phone usability value ($\beta = 0.200$; $p = 0.01$) is positive and significant, thus, H₃ is supported. The results in Table 9 indicate that there is a negative and insignificant ($\beta = -0.096$; $p = 0.20$) relationship between perceived responsiveness and mobile phone usability. Therefore, H₄ is rejected. Finally, Hypothesis 5 also presented a positive and significant ($\beta = 0.316$; $p = 0.01$) relationship between mobile phone usability and mobile marketing acceptance. Therefore, H₅ is also supported.

4.8 Summary of the results

This chapter conveyed a comprehensive discussion on how the data was analysed and how the results were calculated. A data analysis procedure was followed, starting from the data coding; performing descriptive statistics on SPSS software; performing Confirmatory Factor Analysis (CFA) using the AMOS software and path analysis that was also done using AMOS software. Thereafter, validity and reliability tests were performed in order to confirm the consistency and meaningfulness of the measurement instrument. The fitness of the model was also assessed for both the CFA and path model. Moreover, a hypotheses assessment was conducted. The relationships between perceived control and mobile phone usability, perceived responsiveness and mobile phone usability, non-verbal information and mobile phone usability, mobile phone usability and marketing acceptance were deemed positive and significant. However, the relationship between perceived personalisation and mobile phone usability was negative and insignificant.

CHAPTER 5. DISCUSSION OF THE RESULTS

5.1 Introduction

The purpose of this chapter is to discuss the empirical findings of the research as presented in chapter 4. This chapter consists of two sections. The demographic profile of the respondents is presented in the first section, followed by the discussion pertaining to the hypotheses, thereafter.

Prior to executing Structural Equation Model, a descriptive statistical analysis of demographic variables such as gender, marital status, age, academic qualifications and occupation was done. To perform this, SPSS was utilised. As presented in the table below, the study has indicated that the majority of the respondents (63.1%) were female while the rest (36.9%) were male. A possible explanation to these statistics may be because the hair-care industry is a female dominated sector. Previous studies (Browne, 2006; Wingfield, 2009; Dant, Brush & Iniesta, 1996; Linnan & Ferguson, 2007) have indicated that the hair-care business is a vital source of employment for a majority of entrepreneurs, especially women with the clients being mostly females. In addition, according to Bizcommunity (2014), females make up a huge percentage of the informal sector in general.

Concerning age, the majority of the respondents (57.7%) were between the ages of 26 to 35 whereas about 21.2% of the respondents were aged 18 to 25. 16.7% comprised of respondents between the ages of 36 and 45. According to Siqwana-Ndulo (2013), a crucial role for the informal sector is its ability to captivate unemployed people, both young and old. This study has also revealed that about 49.4% had high school education, and approximately 22.5% of respondents achieved tertiary education. These significant statistics of respondents with formal education highlights the lack of employment opportunities in South Africa, therefore making the informal sector a significant player for economic growth (Mahomed, 2015).

Moreover, about 69.2% of the respondents were self-employed and 29.5% employed, signifying that most of the respondents are in the informal hair-care business on a permanent basis while others could be using it as a source of extra income. Therefore,

these demographic characteristics serve as a guide concerning the profiles of the type of people operating in the informal sector, particularly in the hair-care industry.

Table 10: Demographic profile of respondents

Category		Frequency	Percentage (%)	Cumulative (%)
Gender	Male	115	36.9	36.9
	Female	197	63.1	100.0
	Total	312	100.0	
Marital status	Married	85	27.2	27.2
	Single	226	72.4	99.7
	Divorced	1	0.3	100.0
	Total	312	100.0	
Age	17 years or less	9	2.9	2.9
	18 - 25 years	66	21.2	24.0
	26 - 35 years	180	57.7	81.7
	36 - 45 years	52	16.7	98.4
	46 years upwards	52	1.6	100.0
	Total	312	100.0	
Qualification	High School	154	49.4	49.4
	Diploma	37	11.9	61.2
	Degree	29	9.3	70.5
	Postgraduate degree	4	1.3	71.8
	Other	88	28.2	100.0
	Total	312	100.0	
Occupation	Student	1	0.3	0.3
	Employed	92	29.5	29.8
	Self-employed	216	69.2	99.0
	Unemployed	1	0.3	99.4
	Other	2	0.6	100.0
	Total	312	100.0	

5.2 Discussion pertaining to Hypotheses

5.2.1 *Hypothesis 1 (H1): Perceived control has a positive effect on mobile phone usability in the informal hair-care business*

As seen in Figure 4, the study proposed that perceived control (PCL) has a positive effect on mobile phone usability (MPU). Based on the results of this research, PCL is positively correlated with MPU ($\beta = 0.590$; $p = 0.01$) and suggests a strong relation between the two latent constructs. This is in accordance with prior studies where perceived control was also shown to have a significant impact on mobile phone usability (Lee et al., 2015). Therefore, this study confirms that settings that allow mobile phone users to feel like they can control their devices as they wish, provides the most optimal usability experience. Moreover, another study found that perceived behavioural control influences the intention to use and perceived ease of use of mobile commerce directly (Bhatti, 2007; Kim & Sundar, 2014).

5.2.2 *Hypothesis 2 (H2): Perceived responsiveness has a positive effect on mobile phone usability in the informal hair-care business*

As presented in Figure 4, the study proposed that perceived responsiveness (PRS) has a positive effect on mobile phone usability (MPU). Based on the results of this study, it has been validated that the relationship between PRS and MPU is significant and supported ($\beta = 0.285$; $p = 0.01$). Therefore, this signifies that the relationship exists. This suggests that the influence of perceived responsiveness on mobile phone usability in the informal hair-care business is very significant. These findings are in line with studies conducted by Lee et al., (2015) on the impact of interactivity on mobile phone usability, as it was found that perceived responsiveness, as one of the elements of interactivity, has a strong effect on the usability of a mobile phone. Consequently, this study confirms that settings that allow users to receive relevant information in a timely manner provide the most optimum usability experience, as stipulated by the study model.

5.2.3 Hypothesis 3 (H3): Nonverbal information has a positive effect on mobile phone usability in the informal hair-care business

As proposed in Figure 4, nonverbal information (NVI) has a positive effect on mobile phone usability (MPU). Based on the results of this investigation, it has been established that the relationship between NVI and MPU is significant and supported ($\beta = 0.200$; $p = 0.01$). This hypothesis suggests that the effect of nonverbal information on mobile phone usability within the informal hair-care business is strong. A study conducted by Lee et al. (2015) is in accordance with these findings as it was found that mobile phone settings that provide information via multiple channels (touch screen, pictures, size, type, letters, icons, voice recognition, vibration, sound) provide the best usability experience, which is in line with the study model of this research.

Moreover, according to Maeda (2006), several practitioners' guidelines emphasise that interactivity, with nonverbal information being one of its components, plays a vital role in the user experience of products and services. Furthermore, in a study done by Chua, Wan, Chang, and Yi (2014) on mobile devices usage, it was found that icons, pictures and images create excitement for users and makes them feel like they are in a game. Therefore, this study confirms that nonverbal information is a key antecedent of mobile phone usability.

5.2.4 Hypothesis 4 (H4): Perceived personalisation has a positive effect on mobile phone usability in the informal hair-care business

The study proposed that perceived personalisation (PPZ) has a positive effect on mobile phone usability (MPU) as seen in Figure 4. However, this influence is rather negative and insignificant ($\beta = -0.096$; $p = 0.227$). Although literature (Lee et al., 2015) asserts that perceived personalisation has a positive impact on mobile phone usability, this study has failed to validate this due to the Beta and probability value not meeting the minimum criteria that allows a hypothesis to be supported and accepted.

Personalisation is perceived to be the key determining factor of success of mobile phones and services (Asif & Krogstie, 2013). Other studies conducted by Chua et al. (2014) on improving mobile applications usage also confirmed that participants found

it more helpful to be able to personalise content in their mobile phones as they wish, as long as it required less effort.

Moreover, the participants in the study piloted by Chua et al. (2014) were farmers and preferred that mobile phone applications, especially a smartphone, to be more user friendly as it would help them to make pest observation reports. This would enable these farmers to alert other neighbouring farmers of any conditions that may arise, which in turn assist the other farmers to take precautions (Chua et al., 2014). This confirms that in a business environment mobile phones are very important, as they are a quick form of communication, especially when it can be personalised to the user's preference with less effort.

Therefore, several potential explanations of the negative relation in H4 can be identified. The first explanation is that it can be assumed that the informal hair-care business operators find it challenging to personalise their phone, or it could mean that they do not have enough time, given their heavy work schedule to learn how to personalise the content to suit their needs. The second explanation is that there are chances that these operators are sceptical due to theft and security concerns. Asif and Krogstie (2013) argue that the provision of personalised mobile devices is highly sensitive to the user's needs and context.

5.2.5 Hypothesis 5 (H5): Mobile phone usability has a positive effect on mobile marketing acceptance in the informal hair-care business

As professed in Figure 4, the study proposed that mobile phone usability (MPU) has a positive effect on mobile marketing acceptance (MMA). Based on the results of this research, it has been established that the relationship between MPU and MMA is significant and supported ($\beta = 0.316$; $p = 0.01$) and proposes a strong relationship between the two variables. This indicates that the impact of mobile phone usability on mobile marketing acceptance in the informal hair-care business is very strong. A study by Acton (2004) suggested that usability is strongly related to and may affect an overall system's acceptability significantly.

Tractinsky (1997) also found that features of an interface that lead to a user's views of better perception in the usability of a system can result in an augmented user

acceptance of that system. Moreover, ease of use, as reaffirmed by Tractinsky, (1997) is one key feature of usability, thus a mediator of acceptability. Additionally, the TAM states that for users to be able to accept mobile marketing, the device itself must be a useful tool that will assist them in improving their communication efficiently and conveniently (Lu et al., 2009).

5.3 Conclusion

This chapter presented a discussion of the demographic profile of respondents and the hypotheses statements in detail. Although Hypothesis 4 was not supported and insignificant, it is important to note that out of the five proposed hypotheses, four of them tested positive and significant at $p < 0.01$ and $p < 0.01$ level indicating a strong and acceptable relationship.

CHAPTER 6. CONCLUSIONS & RECOMMENDATIONS

6.1 Introduction

The purpose of this chapter is to outline the conclusions from the results presented in Chapter 5. This discussion is then followed by an in-depth discussion of the recommendations. Suggestions for further research are then outlined to conclude this chapter.

6.2 Conclusions of the study

The purpose of this study was to investigate perceived mobile interactivity influence on usability and mobile marketing acceptance in the informal hair-care business. In particular, five hypotheses were proposed. To test the hypotheses, data were collected through an itemised questionnaire administered by the researcher to the respondents who work in the informal hair-care industry based in Johannesburg, South Africa.

6.2.1 Research objectives

The study set out to address five objectives:

a) To investigate the influence of perceived control on mobile phone usability

This study revealed that perceived control has a strong positive effect on mobile phone usability. This shows that through the flow state of a mobile phone in terms of its effectiveness, efficiency and information management, the user (informal–hair-care business operator) is more likely to perceive the usability of it.

b) To investigate the influence of perceived responsiveness on mobile phone usability

It was revealed in the study that perceived responsiveness was the second strongest construct that influences mobile phone usability positively, which indicates that the informal hair-care business operators find their mobile phones able to respond quickly to the inputs or requests, which stimulates their interests to engage and interact with the phones.

c) To investigate the influence of nonverbal information on mobile phone usability

It was found in the study that nonverbal information is an antecedent of mobile phone usability. This implies that the informal hair-care business operators found it beneficial to access relevant information via multiple channels on their mobile phones. I.e. use of images, pictures, touch screen, voice recognition as a way to interact with their phones.

d) To investigate the influence of perceived personalisation on mobile phone usability

The study revealed that perceived personalisation is not a predictor of mobile phone usability. This signifies that the informal hair-care business operators did not find it necessary or relevant to personalise their mobile phones, hence there is a negative impact.

e) To investigate the influence of mobile phone usability on mobile marketing acceptance

Lastly, it was revealed in the study that mobile phone usability is a predecessor of mobile marketing acceptance; the influence is quite strong, significant and positive. This implies that the informal hair-care business operators found their mobile phones to be interactive in a sense that they were able to learn, use, understand and search for information. This in turn influenced their level of using or accepting mobile marketing as a platform to communicate and engage with their customers.

6.2.2 Hypotheses statement

The study set out to test five hypotheses, however, the empirical results supported only four hypotheses and one of the five was insignificant and not supported. The supported hypotheses were; H1: perceived control has a positive effect on mobile phone usability; H2: perceived responsiveness has a positive effect on mobile phone usability; H3: nonverbal information has a positive effect on mobile phone usability and H5: mobile phone usability has a positive effect on mobile marketing acceptance significantly. However, H4: perceived personalisation has a positive effect on mobile phone usability, which was initially hypothesised to be positive, was found to be

negative and insignificant, thus not supported. The table below presents a summary of the analysis results.

Table 10: Structural Equation Model (SEM) Analysis Results

Hypothesised relationships	Hypotheses	Path Coefficients (β)	P-values	Supported / Rejected
PCL→MPU	H ₁	0.590	***	Supported and significant
PRS→MPU	H ₂	0.285	***	Supported and significant
NVI→MPU	H ₃	0.200	***	Supported and significant
PPZ→MPU	H ₄	-0.096	0.20	Not supported
MPU→MMA	H ₅	0.316	***	Supported and significant

Significant @ Significant @ * = 0.10; ** = 0.05; *** = 0.01

The proposed and tested model

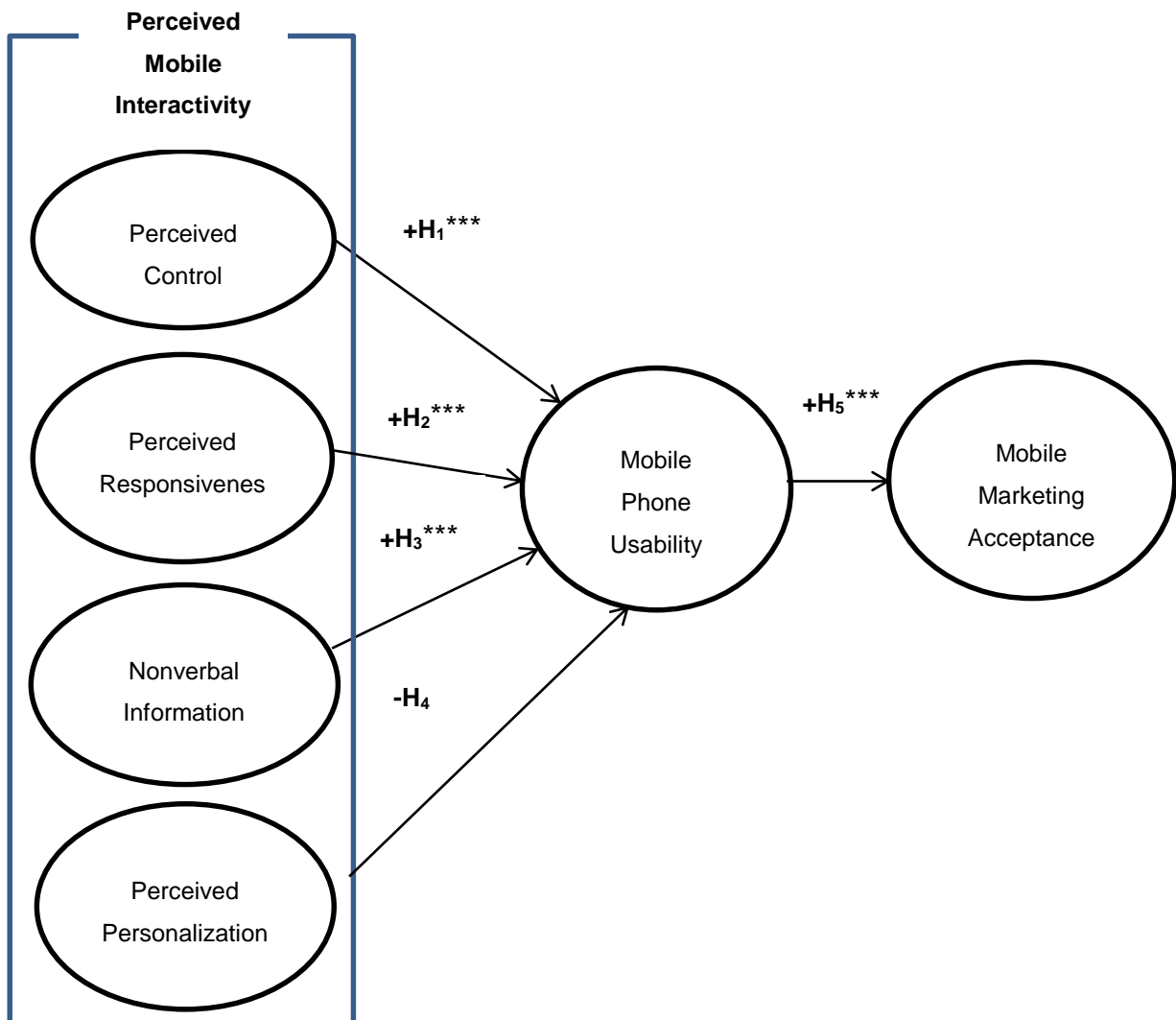

Figure 5: Proposed Model

It is important to note that perceived control was found to have the strongest influence on mobile phone usability ($\beta = 0.590$) in comparison to the other relationships. This implies that the more a user is able to control his or her phone, the higher the perceived ease of use. This finding has an important bearing in the informal hair-care business where mobile phone or devices seem to be the central tool of communication with customers. The mobile phone usability influence on mobile marketing acceptance was found to be the second most important ($\beta = 0.316$), which indicates that the user's usability experience translates into mobile marketing acceptance. This also indicates that when a user finds the mobile phone interface easy to use, he or she will accept using mobile marketing to communicate and stay in touch with customers.

This is also crucial in the informal hair-care industry, where businesses generally lack financial resources and therefore do not have a budget to spend on marketing and advertising. The mobile phone therefore becomes an important marketing channel that needs to be taken advantage of. Mobile marketing will assist these small business operators to develop a customer relationship management system. For instance, this could be achieved through storing customer contact details in their phones, which is a strategy that can be implemented by using some of the mobile applications that allow a user, in this case, the small businesses operator, to group contacts of customers into one singular group in order to interact with them effectively and efficiently.

The study findings indicate that making use of mobile interactivity as a marketing strategy, whether through text messaging or mobile applications, can enhance both the hairdresser's and the consumer's service experience in the hair-care industry. The study has also proven that perceived responsiveness ($\beta = 0.285$) and nonverbal information ($\beta = 0.200$) have a positive effect on mobile phone usability which impact on the overall acceptance of mobile marketing. This indicates that a simple interface is imperative for a positive user interactivity and usability experience, which then leads to mobile marketing acceptance.

Taking into account all four positive hypotheses (H1, H2, H3, H5) as discussed, the results show that operators within the informal hair-care industry feel that they can utilise their mobile phones or devices as they wish to access and provide relevant

information and communication to interact with their customers. This in turn provides the optimum user usability experience, as proposed by the research model.

Intuitively, it is expected that when users personalise their mobile devices, they are likely to perceive ease of use of the devices. Lee et al. (2015) also confirm the positive relationship between perceived personalisation and mobile phone usability. However, it is interesting that the study found perceived personalisation to be negatively related to mobile phone usability (H4). It is suggested that the negative relationship between perceived personalisation and usability ($\beta = -0.096$) may be caused by the limited interface space (screen) of a mobile phone device which, in turn, may limit the usability experience of it.

Taking into consideration the context of the study, which is the informal hair-care business; this could be because these small businesses operators are sceptical about personalising their mobile phones due to safety (theft) and security (hacking) concerns. Additionally, since this industry is physically demanding and the service providers work long hours, these operators generally do not have the time to spend learning how to personalise their phones.

6.3 Recommendations

Some of the justification of this study was that the hair-care business operators are entrepreneurs who could utilise mobile marketing to reach out to a large client base as a retention strategy by offering them customised service offerings. However, it was not known whether these entrepreneurs were using mobile marketing as a marketing tool and if they were, the factors that influenced this adoption were also unknown. Furthermore, little was known in terms of its impact as a marketing platform to enrich their businesses.

This research is one of the few, if not the only one, that studied perceived mobile influence on usability and mobile marketing acceptance within the informal hair-care business, particularly in South Africa. Because of the rapidly growing importance of the informal businesses in creating new employment opportunities and their contribution to economic growth in South Africa and other developing economies, the

findings of this study contribute to the growing body of knowledge to further academic research and policy makers and marketing practitioners.

Businesses are ferociously competing to add new features and functions to their product or service offerings. Therefore, this study shows that perceived interactivity of a mobile phone is important. In order not to impede the quality of the mobile phone usability experience, which might result in a negative relationship with the customers, companies in the mobile phone industry need to consider designing mobile phones in a way that the features and functions are designed through the lens of interactivity.

6.3.1 *Academic implications*

One of the justifications for this study was that it was not known whether the informal hair-care business operators accepted using mobile marketing and if so, the factors that influenced these entrepreneurs to accept or prefer this approach were also not known. Therefore, on the academic front, this study makes a significant contribution to mobile marketing literature by 'shedding some light' on the impact of mobile interactivity influence on usability and mobile marketing acceptance within the informal hair-care businesses in South Africa. In particular, the findings of this study provide support that interactivity dimensions (control, responsiveness and nonverbal information) and usability should be recognised as antecedents of mobile marketing acceptance within the informal hair-care business environment.

6.3.2 *Managerial implications*

1. Policy makers

The findings of the study have provided a theoretical and empirical basis that mobile phone interactivity has a positive influence on usability which in turn influences mobile marketing acceptance. Mobile marketing therefore presents a platform for the survival, prosperity, growth and sustainability of small and informal businesses. Policy makers can introduce mobile marketing training programmes for these businesses, taking into account the cost effectiveness of this marketing strategy.

2. Marketing practitioners

This study is of benefit to both African hair-care industry, such as Unilever (Sunsilk and Motions), L'Oréal (Dark and Lovely) and Sofn'free, and mobile phone manufacturers and telecommunications industry in South Africa.

a) African hair-care industry

The hair-care industry is very competitive and therefore needs to constantly find ways to win over customers. The findings of this study reveal that informal hair-care business operators are willing to use mobile marketing to interact with their customers. The use of mobile marketing will enable hair-care businesses to reach out to a large client base whilst creating sustainable customer relationships, thus yielding customer satisfaction and profitability, and yet creating even more demand for hair-care product/service supplies. Therefore, these companies can leverage on this opportunity to offer distinctive services, such as directly supplying hair-care products to these small businesses. A mobile phone communication strategy for the distribution and supplies of these hair-care products is highly recommended.

Noticeably, mobile phones are a point of communication between customers and the service provider of the hair-care services; it is therefore proposed that such companies look into using these mobile phones to communicate with the owners or operators directly by sending text messages or emails where hair-care products orders and supplies are involved. This study has proven that these business owners are willing to utilise mobile marketing as a communication channel with relevant stakeholders. Therefore, as stakeholders, hair-care companies can take advantage of this opportunity by engaging this sector. Utilising mobile marketing can only mean that there will be even a larger client turn out, creating more demand for hair-care products and supplies.

b) Mobile phone manufacturers

In the current study, the factors and elements of emphasis (perceived control, perceived responsiveness, and nonverbal information) are drivers and antecedents of perceived mobile usability, which in turn has a positive influence on the adoption and

acceptance of mobile marketing within the informal hair-care industry. In accordance with these findings, mobile phone manufactures can design mobile phones that are easy to control, with high input response rate, with an easy interface that will allow for the use of nonverbal information. These mobile phone designs should be more focused on an efficient solution that will minimise disruption of the informal hair-care business operator's daily work routine.

Numerous practitioner guidelines proclaim that interactivity and simplicity play significant roles in the user's experience of technological devices (Lee et al., 2015). For instance, engineers and designers persist that the achievement of Apple's iPhone is attributable to its interactivity and simplicity (Lee et al., 2015). The study model therefore indicates that these mobile phone providers should control and maintain the degree of perceived control, responsiveness, nonverbal information and usability of users in the informal hair-care industry by improving their mobile phones or devices based on their experiences.

Bearing in mind the limited interface space of a mobile phone, it is important that practitioners in the mobile manufacturing sphere provide a much easier interface. The interface should be well systematised, assimilated and prioritised based on the user's frequent interaction with the device. Concurrently, mobile phone settings that allow the user to feel that they have control over his or her phone, while it provides relevant information and communication in an appropriate manner through multiple channels, would provide the best usability experience, as indicated by the study model.

c) Telecommunications industry

Since the study has demonstrated that the use of mobile marketing has a potential to attract a large clientele, this provides an opportunity to the telecommunications industry to provide competitive value-added services as a result of the high volumes of voice and data traffic. Mobile service providers may also offer hugely discounted products and services to attract informal hair-care operators to use their mobile devices to do business, which in turn, will increase their perceived control, perceived responsiveness, use of nonverbal information in their mobile phones which will lead to perceived ease of use, allowing them to utilise mobile marketing effectively.

6.4 Suggestions for further research

Although this study makes a contribution to the current literature, policy makers and marketing practitioners in various industries, it was conducted under limited timeframes and resources. Based on these limitations and the findings of the study, the researcher has identified key areas for future research. Although the data was collected from a sample of 312 respondents, which is considered to be more than adequate for the statistical analyses conducted, the sample was limited to the respondents in the Johannesburg area. It may therefore, be argued that the sample is not representative of the population of the informal hair-care industry in South Africa and wider research could be undertaken in other parts of South Africa. Secondly, studies for future research should not only be limited to South Africa, but other African countries or emerging markets.

Thirdly, the study explored direct relationships between constructs, therefore it is suggested that a study using this model is carried out investigating both direct and indirect relationships between the constructs under investigation. Since the hypothesis, namely, H4: perceived personalisation has a positive effect on mobile phone usability was found to be negative, it is suggested that a study is carried out where perceived personalisation directly influences mobile marketing acceptance. Lastly, future research can also extend from this study by applying the current conceptual model in other sectors of the economy, from small to medium enterprises.

REFERENCES

- Acton, T., Golden, W., Gudea, S., & Scott, M. (2004). Usability and acceptance in small-screen information systems. In *Proceedings of the 9th European Collaborative Electronic Commerce Technology and Research Conference*.
- Adomavicius, G., & Tuzhilin, A. (2005). Personalization technologies: a process-oriented perspective. *Communications of the ACM*, 48(10), 83-90.
- Ajzen, I. (1991). The theory of planned behaviour. *Organizational behaviour and human decision processes*, 50(2), 179-211.
- Ajzen, I., & Fishbein, M. (2008). Scaling and testing multiplicative combinations in the expectancy–value model of attitudes. *Journal of Applied Social Psychology*, 38(9), 2222-2247.
- Amirkhan, J. H. (1998). Attributions as predictors of coping and distress. *Personality and Social Psychology Bulletin*, 24(9), 1006-1018.
- Anderson-Macdonald, S., Chandy, R., & Zia, B. (2014). *The Impact of Marketing (versus Finance) Skills on Firm Performance: Evidence from a Randomized Controlled Trial in South Africa*. Mimeo. London Business School.
- Arbanowski, S., Ballon, P., David, K., Droegehorn, O., Eertink, H., Kellerer, W., & Popescu-Zeletin, R. (2004). I-centric communications: personalization, ambient awareness, and adaptability for future mobile services. *Communications Magazine, IEEE*, 42(9), 63-69.
- Argyriou, E. (2012). Consumer intentions to revisit online retailers: A mental imagery account. *Psychology & Marketing*, 29(1), 25-35.
- Asif, M., & Krogstie, J. (2013). Mobile Services Personalization Evaluation Model. *International Journal of u-and e-Service, Science and Technology*, 6(2), 1-12.
- Babbie, E. (2013). *The Practice of Social Research*. 13th Ed. Wadsworth: Cengage Learning.

- Babin, L. A., & Burns, A. C. (1997). Effects of print ad pictures and copy containing instructions to imagine on mental imagery that mediates attitudes. *Journal of advertising*, 26(3), 33-44.
- Bagozzi, R. P., & Yi, Y. (2012). Specification, evaluation, and interpretation of structural equation models. *Journal of the academy of marketing science*, 40(1), 8-34.
- Bakar, M. S. A., & Bidin, R. (2014). Technology Acceptance and Purchase Intention towards Movie Mobile Advertising among Youth in Malaysia. *Procedia-Social and Behavioral Sciences*, 130, 558-567.
- Barnard, Y., Bradley, M. D., Hodgson, F., & Lloyd, A. D. (2013). Learning to use new technologies by older adults: Perceived difficulties, experimentation behaviour and usability. *Computers in Human Behavior*, 29(4), 1715-1724.
- Barnes, S. J., & Scornavacca, E. (2004). Mobile marketing: the role of permission and acceptance. *International Journal of Mobile Communications*, 2(2), 128-139.
- Barutcu, S. (2007). Attitudes towards mobile marketing tools: A study of Turkish consumers. *Journal of Targeting, Measurement and Analysis for Marketing*, 16, 26–38.
- Bauer, H. H., Barnes, S. J., Reichardt, T., & Neumann, M. M. (2005). Driving consumer acceptance of mobile marketing: a theoretical framework and empirical study. *Journal of electronic commerce research*, 6(3), 181-192.
- Benbunan-Fich, R. (2001). Using protocol analysis to evaluate the usability of a commercial web site. *Information & management*, 39(2), 151-163.
- Bentler, P. M. (2007). Covariance structure models for maximal reliability of unit-weighted composites. *Handbook of latent variable and related models*, 1-19.
- Bhatti, T. (2007). Exploring factors influencing the adoption of mobile commerce. *Journal of Internet Banking and Commerce*, 12(3), 1-13.

Bizcommunity. (2014, 4 December). *Hair today, more tomorrow - SA black hair market shows continued growth*. Retrieved from Bizcommunity website: <http://www.bizcommunity.com/Article/196/168/122251.html>

Blechs Schmidt, T., Wieland, T., Kuhmünch, C., & Mehrmann, L. (2005). Personalization of end user software on mobile devices. In *Mobile Commerce and Services, 2005. WMCS'05. The Second IEEE International Workshop on* (pp. 130-137). IEEE.

Browne, R. C. (2006). Most Black women have a regular source of hair care--but not medical care. *Journal of the National Medical Association, 98*(10), 1652.

Brown, U. J., & Beale, R. L. (2008). Services Marketing: the mediating role of customer satisfaction in the hair care industry. *Academy of Marketing Studies Journal, 12*(1), 57.

Brookes, B., & Smith, C. (2009). Technology and gender: barbers and hairdressers in New Zealand, 1900–1970. *History and Technology, 25*(4), 365-386.

Bruner, G. C., & Kumar, A. (2005). Explaining consumer acceptance of handheld Internet devices. *Journal of business research, 58*(5), 553-558.

Bryman, A. (2012). *Social research methods*. 4th Ed. Oxford: Oxford university press.

Buck, R., & VanLear, C. A. (2002). Verbal and nonverbal communication: Distinguishing symbolic, spontaneous, and pseudo-spontaneous nonverbal behavior. *Journal of Communication, 52*(3), 522-541.

Burgoon, J. K., Bonito, J. A., Bengtsson, B., Ramirez Jr, A., Dunbar, N. E., & Miczo, N. (1999). Testing the interactivity model: Communication processes, partner assessments, and the quality of collaborative work. *Journal of management information systems, 33*-56.

Castañeda, J. A., Frías, D. M., & Rodríguez, M. A. (2009). Antecedents of internet acceptance and use as an information source by tourists. *Online Information Review, 33*(3), 548-567.

Charman, A., & Petersen, L. (2014). *Informal micro-enterprises in a township context: A spatial analysis of business dynamics in five Cape Town localities*. REDi3x3 working paper 5, www. redi3x3. org.

Charman, A. J., Petersen, L. M., Piper, L. E., Liedeman, R., & Legg, T. (2015). Small area census approach to measure the township informal economy in South Africa. *Journal of Mixed Methods Research*, 1–23.

Cheng, S. I., Chen, S. C., & Yen, D. C. (2015). Continuance intention of E-portfolio system: A confirmatory and multigroup invariance analysis of technology acceptance model. *Computer Standards & Interfaces*, 42, 17-23.

Cheung, C., Lee, Z. W., & Chan, T. K. (2015). Self-disclosure in social networking sites: the role of perceived cost, perceived benefits and social influence. *Internet Research*, 25(2), 279-299.

Chinomona, R., & Dhurup, M. (2014). The influence of the quality of working life on employee job satisfaction, job commitment and tenure intention in the SME sector in Zimbabwe. *South African Journal of Economic and Management Sciences*, 17(4), 363-378.

Chinomona, R., Masinge, G., & Sandada, M. (2014). The Influence of E-Service Quality on Customer Perceived Value, Customer Satisfaction and Loyalty in South Africa. *Mediterranean Journal of Social Sciences*, 5(9), 331.

Chinomona, R., & Sandada, M. (2013). The Influence Of Market Related Mobile Activities On The Acceptance Of Mobile Marketing And Consumer Intention To Purchase Products Promoted By SMS In South Africa. *Journal of Applied Business Research (JABR)*, 29(6), 1897-1908.

Chong, W. K., Man, K. L., & Zhang, N. (2011). An Interoperable B2B e-Commerce Framework for e-Marketing Capabilities. *Engineering Letters*, 19(3), 223-227.

Chowdhury, H. K., Parvin, N., Weitenberner, C., & Becker, M. (2006). Consumer attitude toward mobile advertising in an emerging market: An empirical study. *International Journal of Mobile Marketing*, 1(2), 33–42.

- Chu, K. M., & Yuan, B. J. (2013). The Effects of Perceived Interactivity on E-Trust and E-Consumer Behaviors: The Application of Fuzzy Linguistic Scale. *Journal of Electronic Commerce Research*, 14(1), 124.
- Chua, W. Y., Wan, M. P. H., Chang, K., & Yi, W. (2014). Improving Mobile Applications Usage Experience of Novice Users through User-Acclimatized Interaction: A Case Study.
- Chung, T. S., Wedel, M., & Rust, R. T. (2015). Adaptive personalization using social networks. *Journal of the Academy of Marketing Science*, 44(1), 66-87.
- Cleff, E. B. (2010). Effective approaches to regulate mobile advertising: Moving towards a coordinated legal, self-regulatory and technical response. *Computer Law & Security Review*, 26(2), 158-169.
- Cochrane, T. D. (2014). Critical success factors for transforming pedagogy with mobile Web 2.0. *British Journal of Educational Technology*, 45(1), 65-82.
- Cooney, T. M. (2012). Entrepreneurship skills for growth-orientated businesses. In *Report for the Workshop on 'Skills Development for SMEs and Entrepreneurship, Copenhagen*, 28.
- Coursaris, C., & Kim, D. (2006). A qualitative review of empirical mobile usability studies. *AMCIS 2006 Proceedings*, 352.
- Cox, J., & Dale, B. G. (2001). Service quality and e-commerce: an exploratory analysis. *Managing Service Quality: An International Journal*, 11(2), 121-131.
- Cummings, J., Butler, B., & Kraut, R. (2002). The quality of online social relationships, *Comm. of the ACM*, 45 (7), 103-107.
- Dahnil, M. I., Marzuki, K. M., Langgat, J., & Fabeil, N. F. (2014). Factors influencing SMEs adoption of social media marketing. *Procedia-Social and Behavioral Sciences*, 148, 119-126.
- Dant, R. P., Brush, C. G., & Iniesta, F. P. (1996). Participation patterns of women in franchising. *Journal of Small Business Management*, 34(2), 14.

- Davis, F. D. (1989). Perceived usefulness, perceived ease of use, and user acceptance of information technology. *MIS Quarterly*, 13, 319–341.
- Derks, D., Fischer, A. H., & Bos, A. E. (2008). The role of emotion in computer-mediated communication: A review. *Computers in Human Behavior*, 24(3), 766-785.
- Dholakia, R. R., Zhao, M., Dholakia, N., & Fortin, D. (2001). Interactivity and revisits to websites: A theoretical framework. In *American Marketing Association. Conference Proceedings*, 12, 108.
- Dholakia, R. R., Zhao, M., Dholakia, N., & Fortin, D. R. (2000). Interactivity and revisits to websites: A theoretical framework.
- Diamantopoulos, A., & Siguaw, J. A. (2000). *Introducing LISREL: A guide for the uninitiated*. Thousand Oaks, CA: Sage.
- Dolan, D. (2014, 11 August). *Global giants ogle the African hair-care industry*. Retrieved from BusinessDay (BDlive) website:
<http://www.bdlive.co.za/africa/africanbusiness/2014/08/11/global-giants-ogle-the-african-hair-care-industry>.
- Durham, L. (2011). *Understand ethnic customers to meet their hair and beauty needs*. Retrieved from: http://www.supermarket.co.za/SR_Downloads/S&R%20Aug%202011%20Personal%20care.pdf.
- Erturkoglu, Z., Zhang, J., & Mao, E. (2015). Pressing the Play Button: What Drives the Intention to Play Social Mobile Games?. *International Journal of E-Business Research (IJEER)*, 11(3), 54-71.
- Etzo, S., & Collender, G. (2010). The Mobile Phone ‘Revolution’ in Africa: Rhetoric or Realty?. *African affairs*, 45.
- Fan, H., & Poole, M. S. (2006). What is personalization? Perspectives on the design and implementation of personalization in information systems. *Journal of Organizational Computing and Electronic Commerce*, 16(3-4), 179-202.

- Farquhar, J., & Michels, N. (2015). A Quality Framework for Case Study Research: "Convincingness". In *Marketing Dynamism & Sustainability: Things Change, Things Stay the Same*, 346-349.
- Fellows, R. F., & Liu, A. M. (2015). *Research methods for construction*. New York: John Wiley & Sons.
- Field, A. P. (2005). *Discovering Statistics Using SPSS*. (2nd ed.). London: Sage.
- Flavián, C., Guinalíu, M., & Gurrea, R. (2006). The role played by perceived usability, satisfaction and consumer trust on website loyalty. *Information & Management*, 43(1), 1-14.
- Florenthal, B., & Shoham, A. (2010). Four-mode channel interactivity concept and channel preferences. *Journal of Services Marketing*, 24(1), 29-41.
- Fornell, C., & Larcker, D. F. (1981). Evaluating structural equation models with unobservable variables and measurement error. *Journal of marketing research*, 39-50.
- Frank, J., & Harnisch, M. J. (2014). Review on Benefits and Risks of Personalization and Solutions for Privacy Concerns. *Computer*, 2(1), 35-46.
- Frøkjær, E., Hertzum, M., & Hornbæk, K. (2000, April). Measuring usability: are effectiveness, efficiency, and satisfaction really correlated?. In *Proceedings of the SIGCHI conference on Human Factors in Computing Systems*, 345-352.
- Gao, T. T., Rohm, A. J., Sultan, F., & Pagani, M. (2013). Consumers un-tethered: A three-market empirical study of consumers' mobile marketing acceptance. *Journal of Business Research*, 66(12), 2536-2544.
- Gavilan, D., Avello, M., & Abril, C. (2014). The mediating role of mental imagery in mobile advertising. *International Journal of Information Management*, 34(4), 457-464.
- Geldhof, G. J., Preacher, K. J., & Zyphur, M. J. (2014). Reliability estimation in a multilevel confirmatory factor analysis framework. *Psychological Methods*, 19(1), 72.

Gist, M. E., & Mitchell, T. R. (1992). Self-efficacy: A theoretical analysis of its determinants and malleability. *Academy of Management review*, 17(2), 183-211.

Grace, J. B. (2006). *Structural Equation Modeling and Natural Systems*. Cambridge: Cambridge University Press.

Green, J. M., & Baston, H. A. (2003). Feeling in control during labor: concepts, correlates, and consequences. *Birth*, 30(4), 235-247.

Grönroos, C., Heinonen, F., Isoniemi, K., & Lindholm, M. (2000). The NetOffer model: a case example from the virtual marketplace. *Management Decision*, 38(4), 243-252.

Guliwe, T. (2013, 6 May). *Informal traders get a leg up in Gauteng*. Retrieved from: <http://www.iol.co.za/business/news/informal-traders-get-a-leg-up-in-gauteng-1.1510634#.VaVpqcsW9jo>.

Guo, B., Aveyard, P., Fielding, A., & Sutton, S. (2008). Testing the convergent and discriminant validity of the Decisional Balance Scale of the Transtheoretical Model using the Multi-Trait Multi-Method approach. *Psychology of Addictive Behaviors*, 22(2), 288.

Guo, X., Sun, Y., Yan, Z., & Wang, N. (2012). Privacy-Personalization Paradox in Adoption of Mobile Health Service: The Mediating Role of Trust. In *PACIS* (p. 27).

Ha, L., & James, E. L. (1998). Interactivity re-examined: A baseline analysis of early business web sites. *Journal of Broadcasting & Electronic Media*, 42(4), 457-474.

Haghirian, P., & Inoue, A. (2007). An advanced model of consumer attitudes toward advertising on the mobile internet. *International Journal of Mobile Communications*, 5(1), 48–67.

Hakansson, H. (2014). *Corporate Technological Behaviour (Routledge Revivals): Co-operation and Networks*. London: Routledge.

Hamidi, A., & Safabakhsh, M. (2011). The impact of information technology on E. marketing. *Procedia Computer Science*, 3, 365-368.

Hassenzahl, M., Beu, A., & Burmester, M. (2001). Engineering joy. *Ieee Software*, 18(1), 70.

Heeter, C. (2000). Interactivity in the context of designed experiences. *Journal of Interactive Advertising*, 1(1), 3-14.

Heo, J., Ham, D. H., Park, S., Song, C., & Yoon, W. C. (2009). A framework for evaluating the usability of mobile phones based on multi-level, hierarchical model of usability factors. *Interacting with Computers*, 21(4), 263-275.

Ho, S. C., Chen, J. L., & Luo, S. T. (2015). What Users Want: the Factors that Determine the Retention of Social Location-Based Services. *Pacific Asia Journal of the Association for Information Systems*, 7(1).

Hooper, D., Coughlan, J. & Mullen, M.R. (2008). Structural Equation Modelling: Guidelines for Determining Model Fit. *The Electronic Journal of Business Research Methods*, 6(1), 53-60.

Hornbæk, K., & Law, E. L. C. (2007). Meta-analysis of correlations among usability measures. In *Proceedings of the SIGCHI conference on Human factors in computing systems*, 617-626.

Hsieh, P. J. (2015). Healthcare professionals' use of health clouds: Integrating technology acceptance and status quo bias perspectives. *International journal of medical informatics*, 84(7), 512-523.

Hsu, H. H., Lu, H. P., & Hsu, C. L. (2008). Multimedia Messaging Service acceptance of pre-and post-adopters: a sociotechnical perspective. *International Journal of Mobile Communications*, 6(5), 598-615.

Hui, M. K., & Bateson, J. E. (1991). Perceived control and the effects of crowding and consumer choice on the service experience. *Journal of Consumer Research*, 174-184.

Jameson, A. (2009). Adaptive interfaces and agents. *Human-Computer Interaction: Design Issues, Solutions, and Applications*, 105.

Johnson, D. E. (2014). 14 Descriptive statistics. *Research Methods in Linguistics*, 288.

Johnson, G. J., Bruner II, G. C., & Kumar, A. (2006). Interactivity and its facets revisited: Theory and empirical test. *Journal of Advertising*, 35(4), 35-52.

Johnson, R. D., Marakas, G. M., & Palmer, J. W. (2006). Differential social attributions toward computing technology: An empirical investigation. *International Journal of Human-Computer Studies*, 64(5), 446-460.

Judge, T. A., Bono, J. E., & Locke, E. A. (2000). Personality and job satisfaction: the mediating role of job characteristics. *Journal of applied psychology*, 85(2), 237.

Karvonen, K. (2000, November). *The beauty of simplicity*. In Proceedings on the 2000 conference on Universal Usability, 85-90.

Kéïta, S., Faye, O., Kané, B. D., Ndiaye, H. T., Traoré, P., & Coulibaly, K. (2005). Hair care and hairstyles in women in Bamako, Mali. *International journal of dermatology*, 44(s1), 26-29.

Kim, H., Chan, H. C., & Gupta, S. (2007). Value-based adoption of mobile internet: An empirical investigation. *Decision Support Systems*, 43(1), 111–126.

Kim, S. (2011). Web-interactivity dimensions and shopping experiential value. *Journal of Internet Business*, (9), 1.

Kim, H., Lee, I., & Kim, J. (2008). Maintaining continuers vs. converting discontinuers: relative importance of post-adoption factors for mobile data services. *International Journal of Mobile Communications*, 6(1), 108-132.

Kim, H. W., Chan, H. C., & Gupta, S. (2007). Value-based adoption of mobile internet: an empirical investigation. *Decision Support Systems*, 43(1), 111-126.

Kim, K. J., & Sundar, S. S. (2014). Does screen size matter for smartphones? Utilitarian and hedonic effects of screen size on smartphone adoption. *Cyberpsychology, Behavior, and Social Networking*, 17(7), 466-473.

Kim, Y. H., Kim, D. J., & Wachter, K. (2013). A study of mobile user engagement (MoEN): Engagement motivations, perceived value, satisfaction, and continued engagement intention. *Decision Support Systems*, 56, 361-370.

Kleijnen, M., De Ruyter, K., & Wetzels, M. (2007). An assessment of value creation in mobile service delivery and the moderating role of time consciousness. *Journal of Retailing*, 83(1), 33-46.

Kline, R. B. (2005). *Principles and Practice of Structural Equation Modelling* (2nd ed.). New York: The Guilford Press.

Ko, E., Kim, E. Y., & Lee, E. K. (2009). Modeling consumer adoption of mobile shopping for fashion products in Korea. *Psychology & Marketing*, 26(7), 669-687.

Kolb, B. (2008). *Marketing Research: A Practical Approach*. Thousand Oaks, California: SAGE Publications Inc.

Komiak, S. Y., & Benbasat, I. (2006). The effects of personalization and familiarity on trust and adoption of recommendation agents. *Mis Quarterly*, 941-960

Koufaris, M. (2002). Applying the technology acceptance model and flow theory to online consumer behavior. *Information systems research*, 13(2), 205-223.

Kulviwat, S., Bruner, I. I., Gordon, C., Kumar, A., Nasco, S. A., & Clark, T. (2007). Toward a unified theory of consumer acceptance technology. *Psychology & Marketing*, 24(12), 1059-1084.

Larwin, K., & Harvey, M. (2012). A Demonstration of a systematic Item-Reduction Approach Using Structural Equation Modelling. *Practical Assessment, Research & Evaluation*, 12(8), 1531-7714.

Lavie, T., & Tractinsky, N. (2004). Assessing dimensions of perceived visual aesthetics of web sites. *International journal of human-computer studies*, 60(3), 269-298.

Lavinsky, D. (2013, 8 March). *Is Traditional Marketing Still Alive?* Retrieved from Forbes website: <http://www.forbes.com/sites/davelavinsky/2013/03/08/is-traditional-marketing-still-alive/2/>.

Lee, D., Moon, J., Kim, Y. J., & Mun, Y. Y. (2015). Antecedents and consequences of mobile phone usability: Linking simplicity and interactivity to satisfaction, trust, and brand loyalty. *Information & Management*, 52(3), 295-304.

Lee, J. G. (2015). *Business Statistics Made Easy in SAS*. Johannesburg: Silk Route Press.

Lee, T. (2005). The impact of perceptions of interactivity on customer trust and transaction intentions in mobile commerce. *Journal of Electronic Commerce Research*, 6(3), 165.

Lee, T., & Jun, J. (2007). The role of contextual marketing offer in mobile commerce acceptance: Comparison between mobile commerce users and nonusers. *International Journal of Mobile Communications*, 5(3), 339–356.

Lee, S., & Park, S. (2006). Improving accessibility and security for mobile phone shopping. *Journal of Computer Information Systems*, 46(3), 124-133.

Lee, T. (2005). The impact of perceptions of interactivity on customer trust and transaction intentions in mobile commerce. *Journal of Electronic Commerce Research*, 6(3), 165-180.

Lee, Y. H., & Qiu, C. (2009). When uncertainty brings pleasure: The role of prospect imageability and mental imagery. *Journal of Consumer Research*, 36(4), 624-633.

Lee, J. H., Phaal, R., & Lee, S. H. (2013). An integrated service-device-technology roadmap for smart city development. *Technological Forecasting and Social Change*, 80(2), 286-306.

Lei, P. W., & Wu, Q. (2007). Introduction to Structural Equation Modelling: Issues and Practical Considerations. *Educational Measurement: Issues and Practice*, 26(3), 33-43.

Lemay Jr, E. P., Clark, M. S., & Feeney, B. C. (2007). Projection of responsiveness to needs and the construction of satisfying communal relationships. *Journal of personality and social psychology*, 92(5), 834.

- Li, Y. M., & Yeh, Y. S. (2010). Increasing trust in mobile commerce through design aesthetics. *Computers in Human Behavior*, 26(4), 673-684.
- Liang, T. P., Lai, H. J., & Ku, Y. C. (2006). Personalized content recommendation and user satisfaction: Theoretical synthesis and empirical findings. *Journal of Management Information Systems*, 23(3), 45-70.
- Ligthelm, A. A. (2008). A targeted approach to informal business development: the entrepreneurial route. *Development Southern Africa*, 25(4), 367-382.
- Ligthelm, A. A. (2013). Confusion about entrepreneurship? Formal versus informal small businesses. *South African Business Review*, 17(3), 57-75
- Linnan, L. A., & Ferguson, Y. O. (2007). Beauty salons: a promising health promotion setting for reaching and promoting health among African American women. *Health education & behaviour*.
- Liu, Y., & Shrum, L. J. (2002). What is interactivity and is it always such a good thing? Implications of definition, person, and situation for the influence of interactivity on advertising effectiveness. *Journal of advertising*, 31(4), 53-64.
- Liu, Y. (2003). Developing a scale to measure the interactivity of websites. *Journal of advertising research*, 43(02), 207-216.
- Lu, Y., Zhou, T., & Wang, B. (2009). Exploring Chinese users' acceptance of instant messaging using the theory of planned behavior, the technology acceptance model, and the flow theory. *Computers in human behavior*, 25(1), 29-39.
- Luarn, P., & Lin, H. H. (2005). Toward an understanding of the behavioral intention to use mobile banking. *Computers in human behavior*, 21(6), 873-891.
- Lunardo, R., & Mbengue, A. (2009). Perceived control and shopping behaviour: The moderating role of the level of utilitarian motivational orientation. *Journal of Retailing and Consumer Services*, 16(6), 434-441.
- Maeda, J. (2006). *The laws of simplicity*. Boston: MIT press.

- Maisel, N. C., & Gable, S. L. (2009). The paradox of received social support: The importance of responsiveness. *Psychological Science, 20*(8), 928-932.
- Mahatanankoon, P. (2007). The effects of personality traits and optimum stimulation level on text-messaging activities and m-commerce intention. *International Journal of Electronic Commerce, 12*(1), 7-30.
- Manganari, E. E., Siomkos, G. J., Rigopoulou, I. D., & Vrechopoulos, A. P. (2011). Virtual store layout effects on consumer behaviour: applying an environmental psychology approach in the online travel industry. *Internet Research, 21*(3), 326-346.
- Martin, J., Mortimer, G., & Andrews, L. (2015). Re-examining online customer experience to include purchase frequency and perceived risk. *Journal of Retailing and Consumer Services, 25*, 81-95.
- Martí Parreño, J., Sanz-Blas, S., Ruiz-Mafé, C., & Aldás-Manzano, J. (2013). Key factors of teenagers' mobile advertising acceptance. *Industrial Management & Data Systems, 113*(5), 732-749.
- Mazursky, D., & Vinitzky, G. (2005). Modifying consumer search processes in enhanced on-line interfaces. *Journal of Business Research, 58*(10), 1299-1309.
- Mesquita, C., Barbosa, S., & de Lucena, C. (2002). *Towards the identification of concerns in personalization mechanisms via scenarios*. In Proceedings of the 1st Conference on Aspect-Oriented Requirements Engineering and Architecture Design (pp. 25-31).
- McDonald, R.P. & Ho, M.H.R. (2002). Principles and Practice in Reporting Statistical Equation Analyses. *Psychological Methods, 7*(1), 64-82.
- McDonald, R. P. (1970). The theoretical foundations of principal factor analysis, canonical factor analysis, and alpha factor analysis. *British Journal of Mathematical and Statistical Psychology, 23*(1), 1-21.
- Mchombu, C. M. (2000). Information needs of women in small businesses in Botswana. *The International Information & Library Review, 32*(1), 39-67.

McMillan, S. J. (2000). The microscope and the moving target: The challenge of applying content analysis to the World Wide Web. *Journalism & Mass Communication Quarterly*, 77(1), 80-98.

McMillan, S. J., & Hwang, J. S. (2002). Measures of perceived interactivity: An exploration of the role of direction of communication, user control, and time in shaping perceptions of interactivity. *Journal of advertising*, 31(3), 29-42.

Mimosette, M. F. F., & Djumene, P. (2015). Factors explaining the adoption of mobile marketing in Cameroon: Exploratory study on the use of SMS as method of transmission of social information. *African Journal of Marketing Management*, 7(2), 20-31.

Mobile Marketing Association of South Africa. (2015). *It is all in the tactics; effective mobile marketing in Africa*. Retrieved from the MMASA website: <http://mmasasa.org/index.do?PageID=6553&PN=1&IX=46859&Sel=1&SelID=133730>

Mahomed, F. (2015, 12 February). *Informal traders play a big role in S.Africa's economy*. Retrieved from: <http://www.cnbcAfrica.com/news/southern-africa/2014/10/29/smes-informal-sector/>

Mun, Y. Y., Jackson, J. D., Park, J. S., & Probst, J. C. (2006). Understanding information technology acceptance by individual professionals: Toward an integrative view. *Information & Management*, 43(3), 350-363.

Murthi, B. P. S., & Sarkar, S. (2003). The role of the management sciences in research on personalization. *Management Science*, 49(10), 1344-1362.

Nadeem, W., Andreini, D., Salo, J., & Laukkanen, T. (2015). Engaging consumers online through websites and social media: A gender study of Italian Generation Y clothing consumers. *International Journal of Information Management*, 35(4), 432-442.

Nah, F. F. H., Zhao, F., & Zhu, W. (2003). Factors influencing users' adoption of mobile computing. *Managing E-Commerce and Mobile Computing Technologies Book*, 260-271.

Nayebi, F., Desharnais, J. M., & Abran, A. (2012, April). The state of the art of mobile application usability evaluation. In *CCECE* (pp. 1-4).

Neuman, L. (2014). *Social research methods: qualitative and quantitative approaches*. (7th ed.). Englewood Cliffs, NJ: Pearson.

News24. (2014, 23 November). *Big hair, big business*. Retrieved from News24 website: <http://www.news24.com/Archives/City-Press/Big-hair-big-business-20150429>.

J. Nielsen (1999). *Designing Web Usability: The Practice of Simplicity*. Berkeley, CA: Peachpit Press.

Niklas, S. J., & Strohmeier, S. (2011). *Exploring the impact of usefulness and enjoyment on mobile service acceptance: A comparative study*. In System Sciences (HICSS), 2011 44th Hawaii International Conference on, 1-10.

Noone, B. M. (2008). Customer perceived control and the moderating effect of restaurant type on evaluations of restaurant employee performance. *International Journal of Hospitality Management*, 27(1), 23-29.

Newell, J., & Meier, M. (2007). Desperately seeking opt-in: a field report from a student-led mobile marketing initiative. *International Journal of Mobile Marketing*, 2(2).

Oblak, T. (2005). The lack of interactivity and hypertextuality in online media. *Gazette*, 67(1), 87-106.

O'Donnell, K., & Cramer, H. (2015, May). *People's Perceptions of Personalized Ads*. In Proceedings of the 24th International Conference on World Wide Web Companion (pp. 1293-1298).

Oliveira, R. D., Cherubini, M., & Oliver, N. (2013). Influence of personality on satisfaction with mobile phone services. *ACM Transactions on Computer-Human Interaction (TOCHI)*, 20(2), 10.

Oliveira, D., Cherubini, R., & N, M, Oliver. (2012). *Influence of usability on customer satisfaction: A case study on mobile phone services*. International Workshop on the Interplay between User Experience (UX) Evaluation and System Development, 14.

Öztaş, Y. B. B. (2015). The Increasing Importance of Mobile Marketing in the Light of the Improvement of Mobile Phones, Confronted Problems Encountered in Practice, Solution Offers and Expectations. *Procedia-Social and Behavioral Sciences*, 195, 1066-1073.

Pahnila, S. (2008). User Attitudes and Behavior Toward Personalization: A Case Study. *IADIS2008*, 284-290.

Park, C. (2006). Hedonic and utilitarian values of mobile internet in Korea. *International Journal of Mobile Communications*, 4(5), 497–508.

Park, E., Baek, S., Ohm, J., & Chang, H. J. (2014). Determinants of player acceptance of mobile social network games: An application of extended technology acceptance model. *Telematics and Informatics*, 31(1), 3-15.

Pereira, S. M., & Leslie, G. (2009). Hypothesis testing. *Australian Critical Care*, 22(4), 187-191.

Perguini, S., & Gonçalves, M. A. (2002). *Recommendation and personalization: a survey*. Technical Report. Computing Research Repository.

Persaud, A., & Azhar, I. (2012). Innovative mobile marketing via smartphones: are consumers ready?. *Marketing Intelligence & Planning*, 30(4), 418-443.

Picot-Lemasson, A., Decocq, G., Aghassian, F., & Leveque, J. L. (2001). Influence of hairdressing on the psychological mood of women. *International journal of cosmetic science*, 23(3), 161-164.

Pierrakos, D., Paliouras, G., Papatheodorou, C., & Spyropoulos, C. D. (2003). Web usage mining as a tool for personalization: A survey. *User modeling and user-adapted interaction*, 13(4), 311-372.

Pourpakchashm, N. (2015). Mobile Marketing Acceptance: The Case of Young Customers in Malaysia. *GSTF Journal on Computing (JoC)*, 4(2), 17.

Rafaeli, S., & Sudweeks, F. (1997). Networked interactivity. *Journal of Computer-Mediated Communication*, 2(4).

Rao Hill, S., & Troshani, I. (2010). Factors influencing the adoption of personalisation mobile services: empirical evidence from young Australians. *International Journal of Mobile Communications*, 8(2), 150-168.

Raykov, T. (2011). Evaluation of convergent and discriminant validity with multitrait-multimethod correlations. *British journal of mathematical and statistical psychology*, 64(1), 38-52.

Raykov, T. (1997). Estimation of composite reliability for congeneric measures. *Applied Psychological Measurement*, 21(2), 173-184.

Recker, J. (2009). *Opportunities and challenges of mobile personalization: An exploratory study*. European Conference on Information Systems (ECIS), 1-13.

Reis, H. T., Clark, M. S., & Holmes, J. G. (2004). Perceived partner responsiveness as an organizing construct in the study of intimacy and closeness. *Handbook of closeness and intimacy*, 201-225.

Rodero, E. (2010). See it on a radio story: Sound Effects and Shots to Evoked Imagery and Attention on Audio Fiction. *Communication Research*, 1-22.

Rogers, Y., Sharp, H., & Preece, J. (2011). *Interaction Design: Beyond Human-Computer Interaction*. 3rd Ed. New York: Wiley.

Rohm, A. J., Gao, T. T., Sultan, F., & Pagani, M. (2012). Brand in the hand: A cross-market investigation of consumer acceptance of mobile marketing. *Business Horizons*, 55(5), 485-493.

Rose, S., Clark, M., Samouel, P., & Hair, N. (2012). Online customer experience in e-retailing: an empirical model of antecedents and outcomes. *Journal of Retailing*, 88(2), 308-322.

Salehan, M., & Negahban, A. (2013). Social networking on smartphones: When mobile phones become addictive. *Computers in Human Behavior*, 29(6), 2632-2639.

Sánchez-Prieto, J. C., Olmos-Migueláñez, S., & García-Peñalvo, F. J. (2016). Informal tools in formal contexts: Development of a model to assess the acceptance of mobile technologies among teachers. *Computers in Human Behavior*, 55, 519-528.

Saunders, M., Lewis P., & Thornhill, A. (2009). *Research Methods for Business Students* (5th ed.). London: Pearson Education Limited.

Scharl, A., Dickinger, A., & Murphy, J. (2005). Diffusion and success factors of mobile marketing. *Electronic commerce research and applications*, 4(2), 159-173.

Schenkman, B. N., & Jönsson, F. U. (2000). Aesthetics and preferences of web pages. *Behaviour & Information Technology*, 19(5), 367-377.

Shankar, V., & Balasubramanian, S. (2009). Mobile marketing: a synthesis and prognosis. *Journal of Interactive Marketing*, 23(2), 118-129.

Shankar, V., Venkatesh., A, Hofacker, C., & Naik, P. (2010). Mobile Marketing in the Retailing Environment: Current Insights and Future Research Avenues. *Journal of Interactive Marketing*, 24, 111–120.

Shapira, B., Shoval, P., Tractinsky, N., & Meyer, J. (2009). ePaper: A personalized mobile newspaper. *Journal of the American Society for Information Science and Technology*, 60(11), 2333-2346.

Shin, D. H. (2009). Determinants of customer acceptance of multi-service network: An implication for IP-based technologies. *Information & Management*, 46(1), 16-22.

Shin, D. H., Jung, J., & Chang, B. H. (2012). The psychology behind QR codes: User experience perspective. *Computers in Human Behavior*, 28(4), 1417-1426.

Siqwana-Ndulo. N. (2013, 13 May). *The Informal Sector in South Africa*. Retrieved from: [http://m.polity.org.za/article/the-informal-sector-in-south Africa-women-street-traders-in-durban-part1-2013-05-13](http://m.polity.org.za/article/the-informal-sector-in-south-Africa-women-street-traders-in-durban-part1-2013-05-13)

SMSSouthAfrica. (2016). *Bulk Text Message Sending in South Africa – Is it in your Businesses Arsenal?*. Retrieved from the SMSSouthAfrica website: <http://www.smssouthafrica.co.za/>

Song, J. H., & Zinkhan, G. M. (2008). Determinants of perceived web site interactivity. *Journal of Marketing*, 72(2), 99-113.

Song, J. H., Hollenbeck, C. R., & Zinkhan, G. M. (2015, January). *Managing Interactive Communications with Customers: The Effects of Social Presence Cues, Personalization, the Speed of Feedback and Situation*. In Proceedings of the 2007 Academy of Marketing Science (AMS) Annual Conference (pp. 296-299). Berlin: Springer International Publishing.

Ström, R., Vendel, M., & Bredican, J. (2014). Mobile marketing: A literature review on its value for consumers and retailers. *Journal of Retailing and Consumer Services*, 21(6), 1001-1012.

Sultan, F., Rohm, A. J., & Gao, T. T. (2009). Factors influencing consumer acceptance of mobile marketing: a two-country study of youth markets. *Journal of Interactive Marketing*, 23(4), 308-320.

Suhr, D. (2006). *The basics of structural equation modeling*. Fort Collins: University of North Colorado.

Suki, N. M. (2011). A structural model of customer satisfaction and trust in vendors involved in mobile commerce. *Int. Journal of Business Science and Applied Management*, 6(2), 17-30.

Sundar, S. S., & Kim, J. (2005). Interactivity and persuasion: Influencing attitudes with information and involvement. *Journal of interactive advertising*, 5(2), 5-18.

Suntornpithug, N., & Khamalah, J. (2010). Machine and person interactivity: the driving forces behind influences on consumers' willingness to purchase online. *Journal of Electronic Commerce Research*, 11(4), 299.

Sustainable Livelihoods Foundation. (2012). *Formalising Informal Micro-Enterprises: Hair-care Businesses and Shipping Containers*. Retrieved from:

<http://livelihoods.org.za/wp-content/uploads/2015/05/Formalising-Informal-Micro-Enterprises-Hair-Care.pdf>.

Symon, G. & Cassell, C. (2012). *Qualitative Organizational Research*. Los Angeles: Sage Publications.

Tabachnick, B. G., & Fidell, L. S. (2007). Multivariate analysis of variance and covariance. *Using multivariate statistics*, 3, 402-407.

Tafarodi, R. W., Milne, A. B., & Smith, A. J. (1999). The confidence of choice: Evidence for an augmentation effect on self-perceived performance. *Personality and Social Psychology Bulletin*, 25(11), 1405-1416.

Tähtinen, J. (2006). *Mobile Advertising or Mobile Marketing. A Need for a New Concept*. In: FeBR 2005 - Frontiers of e-Business Research 2005, Conference Proceedings of eBRF 2005 pp. 152-164.

Tam, K. Y., & Ho, S. Y. (2006). Understanding the impact of web personalization on user information processing and decision outcomes. *Mis Quarterly*, 865-890.

Tavakol, M., & Dennick, R. (2011). Making sense of Cronbach's alpha. *International journal of medical education*, 2, 53.

Taylor, D. G., & Davis, D. F. (2015). Web Site Personalization and Privacy Concern. In *Marketing, Technology and Customer Commitment in the New Economy* (pp. 14-19). Berlin: Springer International Publishing.

Teo, H. H., Oh, L. B., Liu, C., & Wei, K. K. (2003). An empirical study of the effects of interactivity on web user attitude. *International Journal of Human-Computer Studies*, 58(3), 281-305.

Tossell, C. C., Kortum, P., Shepard, C., Barg-Walkow, L. H., Rahmati, A., & Zhong, L. (2012). A longitudinal study of emoticon use in text messaging from smartphones. *Computers in Human Behavior*, 28(2), 659-663.

Tractinsky, N. (1997). *Aesthetics and apparent usability: empirically assessing cultural and methodological issues*, Conference Proceedings on Human Factors in Computing Systems, Atlanta, GA USA, March 22 - 27, pp. 115-122.

Turkina, E. (2013). *Entrepreneurship in the Informal Economy: Models, Approaches and Prospects for Economic Development*. New York: Routledge.

- Umar, S. (2012). The Impact Of Perception Of Interactivity On Customer Trust And Transaction Intentions In Mobile Commerce. *Enrichment*, 2(1).
- Van Riel, A. C., Lemmink, J., Streukens, S., & Liljander, V. (2004). Boost customer loyalty with online support: the case of mobile telecoms providers. *International Journal of Internet Marketing and Advertising*, 1(1), 4-23.
- Van Velsen, L., Van Der Geest, T., Klaassen, R., & Steehouder, M. (2008). User-centered evaluation of adaptive and adaptable systems: a literature review. *The knowledge engineering review*, 23(03), 261-281.
- Varnali, K., & Toker, A. (2010). Mobile marketing research: The-state-of-the-art. *International Journal of Information Management*, 30(2), 144-151.
- Vassiliou, C., Stamoulis, D., & Martakos, D. (2002). *The process of personalizing web content: techniques, workflow and evaluation*. In Procs Int. Conf. on Advances in Infrastructure for Electronic Business, Science and Education on the Internet.
- Venkatesh, V. (2000). Determinants of perceived ease of use: Integrating control, intrinsic motivation, and emotion into the technology acceptance model. *Information systems research*, 11(4), 342-365.
- Venkatesh, V., & Davis, F. D. (2000). A theoretical extension of the technology acceptance model: Four longitudinal field studies. *Management science*, 46(2), 186-204.
- Venkatesh, V., Ramesh, V., & Massey, A. P. (2003). Understanding usability in mobile commerce. *Communications of the ACM*, 46(12), 53-56.
- Vesanen, J., & Raulas, M. (2006). Building bridges for personalization: a process model for marketing. *Journal of Interactive Marketing*, 20(1), 5-20.
- Violato, C., & Hecker, K. G. (2007). How to use structural equation modeling in medical education research: A brief guide. *Teaching and learning in medicine*, 19(4), 362-371.
- Voorveld, H. A., Neijens, P. C., & Smit, E. G. (2011). The Relation Between Actual and Perceived Interactivity. *Journal of Advertising*, 40(2), 77-92.

- Vorster, A. (2015). Fine-tuning formulations: ethnic care. *South African Pharmaceutical and Cosmetic Review*, 42(3), 26-29.
- Wais, J. S., & Clemons, E. K. (2008). Understanding and implementing mobile social advertising. *International Journal of Mobile Marketing*, 3(1), 12–18.
- Wang, H., Meng, Y., & Wang, W. (2013). The role of perceived interactivity in virtual communities: building trust and increasing stickiness. *Connection Science*, 25(1), 55-73.
- Watson, C., McCarthy, J., & Rowley, J. (2013). Consumer attitudes towards mobile marketing in the smart phone era. *International Journal of Information Management*, 33(5), 840-849.
- Webb, J. W., Bruton, G. D., Tihanyi, L., & Ireland, R. D. (2013). Research on entrepreneurship in the informal economy: Framing a research agenda. *Journal of Business Venturing*, 28(5), 598-614.
- Wei, J. T., Lee, M. C., Chen, H. K., & Wu, H. H. (2013). Customer relationship management in the hairdressing industry: An application of data mining techniques. *Expert Systems with Applications*, 40(18), 7513-7518.
- Wellman, B. (2002). Designing the internet for a networked society, *Comm. of the ACM*, 45 (5), 91-96.
- Werts, C. E., Linn, R. L., & Jöreskog, K. G. (1974). Intraclass reliability estimates: Testing structural assumptions. *Educational and Psychological measurement*, 34(1), 25-33.
- Wheaton, D. E. Alwin, D. F., & Summers, G. F. (1977). Assessing reliability and stability in panel models. *Sociological methodology*, 8(1), 84-136
- Wiley, J. F., & Pace, L. A. (2015). Descriptive Statistics and Exploratory Data Analysis. In *Beginning R* (pp. 73-80). New York: Apress.
- Williams, C. C. (2007). Entrepreneurs Operating in the Informal Economy: Necessity or Opportunity Driven? *Journal of Small Business and Entrepreneurship*, 20(3), 309-319.

Williams, C. C., & Nadin, S. (2010). Entrepreneurship and the Informal Economy: An Overview. *Journal of Developmental Entrepreneurship*, 15(4), 361-378.

Wingfield, A. H. (2009). *Doing business with beauty: Black women, hair salons, and the racial enclave economy*. New York: Rowman & Littlefield.

Wu, G. (2005). The mediating role of perceived interactivity in the effect of actual interactivity on attitude toward the website. *Journal of Interactive advertising*, 5(2), 29-39.

Wu, G. M. (2000). *The role of perceived interactivity in interactive ad processing*. The University of Texas at Austin.

Wu, G., & Wu, G. (2006). Conceptualizing and measuring the perceived interactivity of websites. *Journal of Current Issues & Research in Advertising*, 28(1), 87-104.

Yanos, P. T., Roe, D., Markus, K., & Lysaker, P. H. (2015). Pathways between internalized stigma and outcomes related to recovery in schizophrenia spectrum disorders. *Psychiatric Services*.

Yong, A. G., & Pearce, S. (2013). A beginner's guide to factor analysis: Focusing on exploratory factor analysis. *Tutorials in Quantitative Methods for Psychology*, 9(2), 79-94.

Yoo, C. W., Kim, Y. J., & Sanders, G. L. (2015). The impact of interactivity of electronic word of mouth systems and E-Quality on decision support in the context of the e-marketplace. *Information & Management*, 52(4), 496-505.

Yu, C. S. (2012). Factors affecting individuals to adopt mobile banking: Empirical evidence from the UTAUT model. *Journal of Electronic Commerce Research*, 13(2), 104-121.

Yun, G. W. (2007). Interactivity concepts examined: Response time, hypertext, role taking, and multimodality. *Media Psychology*, 9(3), 527-548.

Yu, C. S., & Tao, Y. H. (2009). Understanding business-level innovation technology adoption. *Technovation*, 29(2), 92-109.

Zeithaml, V. A., Parasuraman, A., & Malhotra, A. (2000). Conceptual Framework for understanding e-service quality: Implications for future research and managerial practice.

Zait, P. A., & Berteau, P. S. P. E. (2011). Methods for testing discriminant validity. *Management & Marketing Journal*, 9(2).

Zamith, F. (2008). *A methodological proposal to analyze the news websites use of the potentialities of the Internet*. In 9th International Symposium on Online Journalism, University of Texas at Austin, 4, 05-04.

APPENDIX A

Questionnaire

The University of Witwatersrand
Graduate School of Business
Administration

Cell: 073 471 8555; Email: zulu.melissa@gmail.com

Date: July 2015



Dear Sir/Madam

RE: COMPLETION OF QUESTIONNAIRE

I am a postgraduate student at the University of Witwatersrand – Graduate School of Business Administration, undertaking a Master of Management in the field of Strategic Marketing. The topic of my research is “Perceived mobile interactivity influence on usability and mobile marketing acceptance in the informal hair-care business”. In order to accomplish my research objectives, a questionnaire has been prepared to gather information regarding the following:

- Perceived control
- Perceived responsiveness
- Nonverbal information
- Perceived personalization
- Mobile phone usability
- Mobile marketing acceptance

This is to kindly request you to complete the attached questionnaire. Your response will be of great value to this study. Please also note that the collected data will be treated as confidential and will only be made available to people working on this research.

Yours Sincerely

Melissa Zulu

STUDY SUPERVISOR
PROF. R. CHINOMONA

Please answer the following questions by marking the appropriate answer(s) with an X. This questionnaire is strictly for research purpose only.

SECTION A: GENERAL INFORMATION

The section is asking your background information. Please indicate your answer by ticking (X) on the appropriate box.

A1 Please indicate your gender

Male	<input type="checkbox"/>
Female	<input type="checkbox"/>

A2 Please indicate your marital status

Married	<input type="checkbox"/>
Single	<input type="checkbox"/>

A3 Please indicate your age category

17 years or less	<input type="checkbox"/>
18 – 25 years	<input type="checkbox"/>
26 – 35 years	<input type="checkbox"/>
36 - 45 years	<input type="checkbox"/>
46 years upwards	<input type="checkbox"/>

A4 Please indicate your highest academic qualification

High School	<input type="checkbox"/>
Diploma	<input type="checkbox"/>
Degree	<input type="checkbox"/>
Post graduate degree	<input type="checkbox"/>
Other	<input type="checkbox"/>

A5 Please indicate your occupation

Student	
Employed	
Self-employed	
Unemployed	
Other (specify)	

Please indicate the extent to which you agree or disagree with the statement by ticking the corresponding number in the 7-point scale below:

1	2	3	4	5	6	7
Strongly Disagree	Disagree	Slightly Disagree	Neutral	Slightly Agree	Agree	Strongly Agree

SECTION B:

1. Perceived control

Please indicate to what extent you agree or disagree with each statement regarding perceived control								
		Strongly Disagree	Disagree	Slightly Disagree	Neutral	Slightly Agree	Agree	Strongly Agree
1	I can freely move through my cellphone menu.							
2	I know how to control my cellphone efficiently.							
3	I can manage information on my cellphone as I wish.							
4	Overall, I can control my cellphone well.							

2. Perceived responsiveness

Please indicate to what extent you agree/disagree with the following statements regarding perceived responsiveness		Strongly Disagree	Disagree	Slightly Disagree	Neutral	Slightly Agree	Agree	Strongly Agree
1	My cellphone quickly responds to my input (e.g., textual input, numeric input).							
2	My cellphone gives relevant information with respect to my input.							
3	My cellphone has no delay in operations (e.g., loading time, saving time).							

3. Nonverbal information

Please indicate to what extent you agree/disagree with the following statements regarding nonverbal information		Strongly Disagree	Disagree	Slightly Disagree	Neutral	Slightly Agree	Agree	Strongly Agree
1	My cellphone provides interactive interface by using icons, images, and moving pictures.							
2	My cellphone provides appropriate auditory and tactile feedback (e.g., sounds, vibration).							
3	My cellphone provides auditory and tactile input (e.g., voice recognition, touch screen).							
4	My cellphone provides intuitive icons and images on its interface.							

4. Perceived personalisation

Please indicate to what extent you agree/disagree with the following statements regarding perceived personalisation								
		Strongly Disagree	Disagree	Slightly Disagree	Neutral	Slightly Agree	Agree	Strongly Agree
1	My cellphone's ringtone can be personalised to my preference.							
2	My cellphone's background picture can be personalised to my preference.							
3	My cellphone's menu can be personalised to my preference.							
4	Overall, my cellphone can be tuned for my personal use							

5. Mobile phone usability

Please indicate to what extent you agree or disagree with each statement regarding mobile phone usability								
		Strongly Disagree	Disagree	Slightly Disagree	Neutral	Slightly Agree	Agree	Strongly Agree
1	I can easily understand the overall interface of my cellphone.							
2	It is easy to learn how to use my cellphone.							
3	I can easily and quickly find what I want in my cellphone.							
4	It is easy to use my cellphone.							
5	It is easy to remember how to use my cellphone.							

6. Mobile marketing acceptance

Please indicate to what extent you agree or disagree with each statement regarding mobile marketing acceptance		Strongly Disagree	Disagree	Slightly Disagree	Neutral	Slightly Agree	Agree	Strongly Agree
1	I will send or share information with clients concerning hair-care products on my cellphone.							
2	I will send out discounts or promotions to clients on my cellphone.							
3	Overall, I will send requests to clients whom gave me permission.							