

**OPERATIONAL PERFORMANCE OF THE  
ANAEROBIC BAFFLED REACTOR  
USED TO TREAT WASTEWATER  
FROM A PERI-URBAN COMMUNITY**

**OCTOBER 2010**

**Operational Performance of the  
Anaerobic Baffled Reactor  
Used to Treat Wastewater  
from a Peri-Urban Community**

by

**Kerri Hudson**

A Research Report submitted to the Faculty of Engineering and the Built Environment, University of the Witwatersrand, Johannesburg in partial fulfilment of the requirements for the degree of Master of Science in Engineering.

Johannesburg  
October 2010

---

# PREFACE

The work presented in this dissertation was performed at the University of KwaZulu-Natal, Howard College Campus, from May 2004 to February 2005. The work was supervised by Katherine Foxon and Professor C. A. Buckley (Pollution Research Group, University of KwaZulu-Natal), and co-supervised Professor P. Marjanovic (School of Civil and Environmental Engineering, University of the Witwatersrand).

This study is part of a broader Anaerobic Baffled Reactor (ABR) research programme funded by the Water Research Commission (Project number: K5/1248), and the various parts of the work were completed by different members of the project team. Many components of this project have been published by different members of the project team.

The author was part of the project team as a research assistant responsible for the general maintenance and operation of the ABR, as well as monitoring of Chemical Oxygen Demand and solids levels in the influent, effluent and each compartment. It was agreed with the Pollution Research Group that the author could use some of her own data as well as other supporting data from the project for the research component of a Master's degree through the University of the Witwatersrand.

As far as this research project is concerned, the microbial work was performed by Sudhir Pillay at the School for Life and Environmental Sciences, and Ammonia, Nitrogen, Phosphorous and alkalinity analyses were performed by Divesha Moodley at the School of Chemistry. All other data and photographs presented herein, operation of the ABR

and sample collection and analysis were performed by the author, Kerri Hudson.

All of the work presented in this Research Report is original, unless otherwise stated. It has not (in whole or in part) been previously submitted by the author to any tertiary institute as part of a degree requirement.

Kerri Hudson: \_\_\_\_\_

Date: \_\_\_\_\_

---

# ACKNOWLEDGMENTS

I would like to thank the following for all the input and assistance they have given during this project:

- Professor Chris Buckley (Head of the Pollution Research Group, School of Chemical Engineering) for the opportunity to work on the ABR project with the Pollution Research Group, and for his supervision and valuable input into this study.
- Katherine Foxon (ABR project leader, Pollution Research Group) for her continued assistance, patience and supervision, revision of data and results, and without whom I would not have completed my research.
- Sudhir Pillay (School of Life and Environmental Sciences, UKZN) for his input with the microbial analyses and participation in sampling expeditions.
- Divesha Moodley (School of Chemistry, UKZN) for her input with the chemical analyses.
- Nicholas Du Preez and the rest of my family for their support and encouragement, and all my other friends and colleagues from Chem Eng at UKZN.

---

*"Water is fundamental for life and health. The human right to water is indispensable for leading a healthy life in human dignity. It is a pre-requisite to the realization of all other human rights."*

--- The United Nations Committee on Economic, Cultural and Social Rights ---

---

---

# ABSTRACT

An estimated 37% of the population in South Africa are currently without basic sanitation facilities. Poor sanitation may lead to the spread of disease and increased contamination of ground and surface water resources. The demand for basic services continues to exceed supply and limited progress has been made in elimination of backlogs. As a result, various low-cost sanitation alternatives, are being investigated, including urine diversion toilets and Ventilated Improved Pit (VIP) latrines. Research is also being conducted for the use of anaerobic baffled reactors to treat water from peri-urban communities and industrial wastewater, with positive results.

The Anaerobic Baffled Reactor (ABR) is a high rate anaerobic reactor, which has a series of hanging and standing baffles that form several equal volume compartments to force the wastewater up and down through each compartment as it flows from the inlet to the outlet of the reactor. The ABR has been found to treat high strength organic loads, and has consistently high Chemical Oxygen Demand (COD) removal. It does not require external power and meets the other requirements for a sanitation alternative.

This study forms part of a larger Water Research Commission (WRC) Project, conducted by the Pollution Research Group at the University of KwaZulu-Natal, which investigated the feasibility of "the anaerobic baffled reactor for sanitation in dense peri-urban areas". The objective of this study is to monitor the performance of the ABR in a peri-urban area.

The pilot reactor used for this study was constructed at the University of KwaZulu-Natal, and was set up at the Kingsburgh Wastewater Treatment Works. A submersible pump was used to pump wastewater from the influent channel into the feed box of the ABR. The flow rate of the influent was regulated by a programmable logic controller, which allowed for a relatively constant flow of 1.6 l/min to the ABR, where the unused feed overflowed back into the channel.

Over an operational period of 6 months, samples from the influent and effluent of the ABR were collected and analysed on a regular basis. The influent and effluent results were compared in order to monitor the performance of the ABR. The following parameters were investigated:

- Chemical Oxygen Demand
- Solids
- pH
- Alkalinity
- Phosphates
- Total Kjeldahl Nitrogen
- Faecal coliforms

There were no major stoppages during the study period, and only a few minor flow incidents, as a result sufficient data was obtained to monitor the performance of the reactor. The hydraulic retention time was approximately 42 hours.

The percentage removal of COD by the ABR shows that the average reduction in COD is 83%, and removal rates were consistently between 78% and 90%. Solids were consistently low in the effluent, showing a removal efficiency of 40% - 70%.

On site measurements for pH presented an average of 7.2 for the influent, and an average of 6.5 for the effluent samples. Alkalinity concentrations were averaged to 256 mgCaCO<sub>3</sub>/l for the influent samples and 246 mgCaCO<sub>3</sub>/l for the effluent samples. The



alkalinity results for this study were low when compared to typical anaerobic treatment systems, suggesting that the ABR was poorly buffered, however this did not appear to influence the treatment performance of the ABR.

There was a slight decrease in Phosphates; however this was not considered a significant decrease. Anaerobic digestion has no mechanism to remove Phosphates or Phosphorous, as a result this decrease is attributed to the relatively few number of samples. A slight reduction on TKN was observed due to treatment by the ABR; however no significant trends were noted.

There was a significant reduction in *E. coli* by an average of 76%. The average removal of 86% of coliforms was significant. Although a significant reduction of *E. coli* and coliforms was found, the concentration of faecal coliforms found in the effluent are substantially higher than the DWA guideline for irrigation, which is 1 cfu/100ml, or approximately 10 000 *E. coli* cells.

Significant concentrations of nutrients were still present in the effluent, and as a result, in terms of the Department of Water Affairs (DWA) water quality guidelines, ABR effluent is unsuitable for discharge to surface or groundwater, and may not be used for any activity that may contaminate such water resources.

The ABR achieved significant removal of faecal coliforms, however, there were still high concentrations of indicator organisms in the effluent, and when compared to the DWA guidelines for discharge to natural water resources, and for irrigation and domestic uses, these exceeded the guideline concentrations and are considered a risk to human health. Therefore, the effluent may not be discharged or used without further treatment.

Overall, the ABR proved to be a sturdy treatment system with many biological and hydraulic advantages over the conventional treatment systems (Foxon et al., 2005). Further the ABR would have lower installation, operation and maintenance costs in comparison with conventional treatment systems, and it provides a viable alternative for communities with dry sanitation that aspire to waterborne sanitation (Foxon et al., 2005).

However, the ABR was not found to treat wastewater to suitable chemical and microbiological standards as a stand alone treatment alternative for any end use, including irri-

gation. For the ABR to become a possible treatment alternative, suitable post-treatment and appropriate uses and/or discharge practises would have to be investigated. The ABR has no means for prevention of the build-up of or for removal of solids, and an ABR treatment system would therefore require a pre-treatment step or maintenance plan for screening and removal of grit and other undesirable material.

---

# TABLE OF CONTENTS

<b>Preface</b>	<b>i</b>
<b>Acknowledgments</b>	<b>iii</b>
<b>Abstract</b>	<b>v</b>
<b>Table of Contents</b>	<b>ix</b>
<b>List of Figures</b>	<b>xiv</b>
<b>List of Tables</b>	<b>xv</b>
<b>1 Introduction</b>	<b>1</b>
1.1 Brief Introduction to the Sanitation Problem in South Africa . . . . .	1
1.2 Requirements for Sanitation Alternatives . . . . .	2
1.3 Water Quality Standards . . . . .	3
1.4 The Anaerobic Baffled Reactor and its Application as a Sanitation Alternative . . . . .	5
1.5 Aim and Objectives . . . . .	6

---

1.5.1	Operational Performance of the ABR . . . . .	7
<b>2</b>	<b>Literature Review</b>	<b>9</b>
2.1	Sanitation in a South African Context . . . . .	9
2.1.1	Current Sanitation Alternatives in Rural Areas . . . . .	10
2.2	Wastewater Constituents . . . . .	12
2.3	Introduction to Anaerobic Digestion . . . . .	14
2.4	Overview of the Anaerobic Baffled Reactor . . . . .	14
2.4.1	Anaerobic Baffled Reactor Designs . . . . .	14
2.4.2	Basic Microbiology of the ABR . . . . .	17
2.4.3	Startup . . . . .	17
2.4.4	Wastewater Treatment . . . . .	18
2.4.5	Suitability in a Peri-Urban Community . . . . .	19
<b>3</b>	<b>Materials and Methods</b>	<b>21</b>
3.1	Equipment . . . . .	21
3.1.1	Setup of the Anaerobic Baffled Reactor at Kingsburgh Wastewater Treatment Works . . . . .	21
3.1.2	Limitations and Problem Solving . . . . .	22
3.2	Analyses . . . . .	24
3.2.1	Chemical Analyses . . . . .	24
3.2.2	Microbial Analyses . . . . .	30

---

3.3	Department of Water Affairs Water Quality Guidelines . . . . .	31
<b>4</b>	<b>Results</b>	<b>32</b>
4.1	Startup of the Anaerobic Baffled Reactor . . . . .	32
4.1.1	Flow and Incidents . . . . .	33
4.2	Chemical Component . . . . .	34
4.2.1	Chemical Oxygen Demand . . . . .	34
4.2.2	Total Solids . . . . .	36
4.2.3	pH and Alkalinity . . . . .	37
4.2.4	Total Kjeldahl Nitrogen . . . . .	37
4.2.5	Phosphates . . . . .	38
4.3	Microbial Component . . . . .	39
4.3.1	Faecal Coliforms . . . . .	39
4.4	Summary of Results . . . . .	40
<b>5</b>	<b>Discussion</b>	<b>42</b>
5.1	Startup . . . . .	42
5.2	Flow and Incidents . . . . .	42
5.3	Chemical Component . . . . .	43
5.3.1	Chemical Oxygen Demand . . . . .	43
5.3.2	Total Solids . . . . .	44

---

5.3.3	pH and Alkalinity . . . . .	45
5.3.4	Total Kjeldahl Nitrogen . . . . .	45
5.3.5	Phosphate . . . . .	46
5.4	Microbial Component . . . . .	46
<b>6</b>	<b>Conclusions</b>	<b>48</b>
6.1	Operation of the pilot Anaerobic Baffled Reactor at the Kingsburgh Waste- water Treatment Plant . . . . .	48
<b>7</b>	<b>Recommendations</b>	<b>51</b>
<b>A</b>	<b>Membrane Study</b>	<b>52</b>
A.1	Introduction . . . . .	52
A.2	Materials and Methods . . . . .	54
A.2.1	Membrane and Unit . . . . .	54
A.2.2	Coliforms . . . . .	55
A.3	Results and Discussion . . . . .	56
A.3.1	Preliminary Flux Tests . . . . .	56
A.3.2	Cleaning Tests at Kingsburgh Wastewater Treatment Plant . . . . .	59
A.3.3	Laboratory Flux Tests . . . . .	59
A.4	Conclusion . . . . .	65
	<b>References</b>	<b>66</b>

---

# LIST OF FIGURES

1.1	Photograph of Valley of a Thousand Hills . . . . .	2
1.2	Schematic diagram of an anaerobic baffled reactor (ABR). . . . .	5
2.1	Original design for the anaerobic baffled reactor . . . . .	15
2.2	Modifications to the Anaerobic Baffled Reactor . . . . .	16
2.3	Schematic diagram of the ABR design for this project . . . . .	16
3.1	Photograph the pump, feed pipes and the splitter box . . . . .	22
4.1	Cumulative flow for the duration of the study period . . . . .	34
4.2	Total COD values for the period of operation . . . . .	35
4.3	COD Percentage Removal . . . . .	35
4.4	Soluble COD values for the period of operation . . . . .	36
4.5	Solids removal for the period of operation . . . . .	37
4.6	Photograph of the influent and effluent . . . . .	38
4.7	Graph showing the concentration of <i>E.coli</i> in the ABR influent and effluent	39

---

4.8	Graph showing the concentration of faecal coliforms in the influent and effluent . . . . .	40
A.1	Kubota A4 membrane cartridge . . . . .	53
A.2	Photograph of membrane unit and ABR . . . . .	55
A.3	Clean Water Flux tests performed in the laboratory using tap water . . . . .	56
A.4	Clean water flux at each head from 100 mm to 750 mm . . . . .	57
A.5	Effluent flux at each head from 100 mm to 850 mm . . . . .	58
A.6	Average flux from each run vs. head height . . . . .	58
A.7	Resultant flux after cleaning tests . . . . .	60
A.8	Graph showing the flux from two clean water runs and the two 5 hour effluent runs on the membrane . . . . .	60
A.9	Graph showing the flux from the 4 day test (of 5 hours per day) on the membrane . . . . .	61
A.10	Graph showing flux over time, for five consecutive days . . . . .	62
A.11	Three sample bottles, from left to right - ABR influent, ABR effluent and membrane filtrate . . . . .	63
A.12	Membrane removal of <i>E. coli</i> . . . . .	64
A.13	Membrane removal of coliforms . . . . .	64



---

# LIST OF TABLES

2.1	Major contaminants of municipal sewage and the associated parameters used to quantify the degree of contamination . . . . .	13
3.1	Incidents that caused ABR downtime. . . . .	24
3.2	Parameter analysed and its importance to the operation of the ABR . . . .	26
3.3	DWA Water Quality Guidelines for Agricultural Water Use: Irrigation for Criteria Water Quality Constituents . . . . .	31
4.1	Details of incidents encountered during operation of the ABR . . . . .	33
4.2	Summary of the results for the operation of the ABR for a period of 162 days	41
A.1	COD results from ABR effluent and membrane filtrate . . . . .	63

---

---

## CHAPTER 1

---

# INTRODUCTION

### **1.1 Brief Introduction to the Sanitation Problem in South Africa**

An estimated 37% of the population in South Africa are currently without basic sanitation facilities (StatsSA, 2009). The majority of these people are from rural areas, peri-urban areas and informal settlements. Poor sanitation has led to the spread of disease and increased contamination of ground and surface water resources, amongst others. The government has been active in attempting to solve the major issues surrounding sanitation, such as restructuring local governments and assigning responsibility, introducing new legislation and funding research programmes, and as a result, considerable improvements have been made. However, the demand for basic services continues to exceed supply and limited progress has been made in elimination of backlogs (Department of Water Affairs, 2002).

Over the past 20 years there has been rapid growth of informal and semi-formal settlements surrounding urban areas. This has led to densely populated peri-urban communities where there is little or no capacity to formalise housing arrangements and provide appropriate water and sanitation services (Foxon et al., 2004).

As a result, various low-cost sanitation alternatives, based on the needs of individual communities are being investigated. Some of these alternatives currently being researched include urine diversion toilets and Ventilated Improved Pit (VIP) latrines. Research is also being conducted for the use of the anaerobic baffled reactors to treat water

from peri-urban communities and industrial wastewater, with favourable results.

## 1.2 Requirements for Sanitation Alternatives

Providing low-cost sanitation in South Africa presents many challenges, as the climate, topography and local regulations prevent conventional low-cost wastewater treatment alternatives in many locations. Many communities, particularly in the KwaZulu-Natal lowlands and midlands, live in areas where there is steep topography, often with deep river valleys. This results in a shortage of space for wastewater treatment processes which require large surface areas, such as ponds, lagoons and reedbeds, and insufficient soil depths for conventional pit latrine soakaways (Foxon et al., 2001).

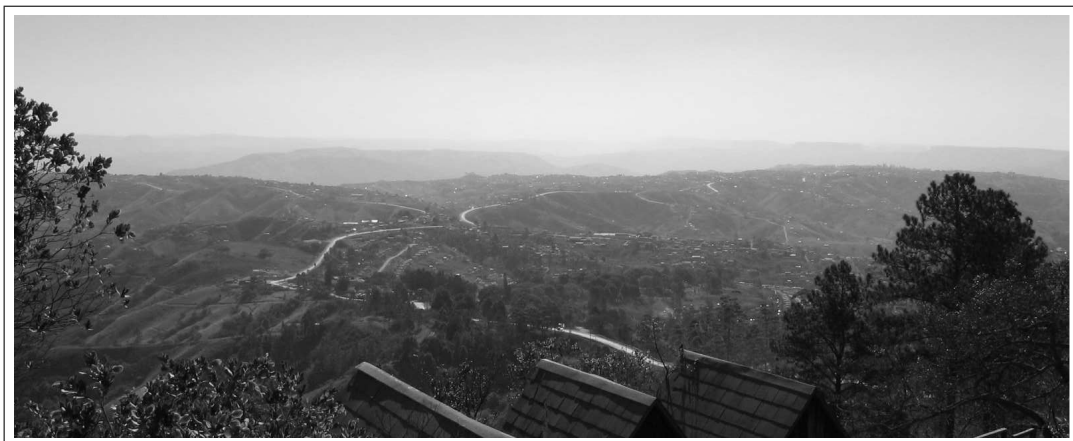

**Figure 1.1:** A photograph of KwaZulu-Natal semi-formal settlements. Photo taken by the author in Valley of a Thousand Hills.

This topography also prevents the construction of adequate infrastructure to and within these communities; in some areas there are no roads at all, and access by maintenance vehicles is severely restricted. The most appropriate treatment technology would therefore have to be much reduced in size, enclosed or protected and require only low level maintenance.

In addition, some areas, particularly in KwaZulu-Natal, receive high rainfall; therefore the treatment process should be protected to prevent overflow of the waste into the surrounding environment (Foxon et al., 2001).

The targeted low-income communities vary greatly in size and density, and as such in their water use patterns. Water use in any one community will also vary throughout the day as people go to and return from places of employment. Furthermore, informal and semi-formal communities may experience fluctuations in population size which affect the quantity and quality of wastewater generated. Hence, the sanitation treatment alternative needs to be resistant enough to cope with the fluctuations in hydraulic and organic loads.

The level of potable water supply is linked to the level of sanitation. Water supply is divided into three-tiered levels of service. The lowest service level is 200 l per day supplied to household ground tanks. The first 200 l per household is free, and the tariff increases with increasing levels of service and consumption. In order to upgrade to semi-pressurized roof tanks (second service tier) or a full pressure supply (third service tier), an appropriate sanitation system needs to be installed (Department of Water Affairs, 2003).

Local municipalities, including eThekweni Metropolitan Municipality, have stated that interim sanitation technology should have no energy requirements and minimal maintenance requirements (Department of Water Affairs, 2002). Further, it should be a requirement that the effluent from the treatment should meet the local river discharge standards, or at least the Department of Water Affairs (DWA) standard for irrigation. Without a pre-treatment stage, the influent would consist of raw domestic wastewater. The treatment alternative should therefore have the capacity to handle the possibility of high solids concentrations and grit build-up.

### **1.3 Water Quality Standards**

Effluent from any water-borne sanitation system that is discharged to the environment is regulated by DWA (Department of Water Affairs, 1996). DWA has published a series of guidelines for effluent quality discharged to different receiving environments.

In terms of the National Water Act (Act 36 of 1998), authorisation is required for:

- The discharge of wastewater into a water body (up to 2 000 kl per day, as long as the effluent does not cause the receiving water temperature to change by more than 3 °C).
- The use of domestic wastewater for irrigation purposes (up to 500 kl per day).

The goal of the national DWA is to maintain water quality within the Target Water Quality Range (TWQR), which is described as “the range of concentrations or levels at which the presence of a particular constituent would have no known or anticipated adverse effects on the fitness of water for a particular use” (Department of Water Affairs, 1996). As a result water quality criteria have been developed, which include scientific and technical information for various water quality constituents, indicating the effects of the constituents on the fitness of water for different water uses. The water quality criteria are presented in the DWA Water Quality Guidelines (Department of Water Affairs, 1996), which have volumes containing guidelines for the following:

- Volume 1: Domestic Water Use
- Volume 2: Recreational Water Use
- Volume 3: Industrial Water Use
- Volume 4: Agricultural Water Use: Irrigation
- Volume 5: Agricultural Water Use: Livestock Watering
- Volume 6: Agricultural Water Use: Aquaculture

These guidelines consist of the water quality criteria, the TWQR and supporting information, such as its effects on organisms, health impacts and potential mitigation or treatment measures.

## 1.4 The Anaerobic Baffled Reactor and its Application as a Sanitation Alternative

The Anaerobic Baffled Reactor (ABR) is an anaerobic treatment system, which employs a series of partial partitions, or hanging and standing baffles to form internal equal volume compartments. Wastewater flows up and down through each compartment, from the inlet to the outlet of the reactor (Barber and Stuckey, 1999). The solids in the wastewater settle out in each compartment, forming a solids layer within which anaerobic microorganisms develop. The solids layer gradually develops into sludge beds in the bottom of each compartment. The incoming liquid wastewater passes through these sludge beds, as it flows under the hanging baffles, as shown in Figure 1.2. This design allows for increased contact between the wastewater and the biomass in the sludge beds, and for various stages of anaerobic digestion to continue simultaneously in each compartment.

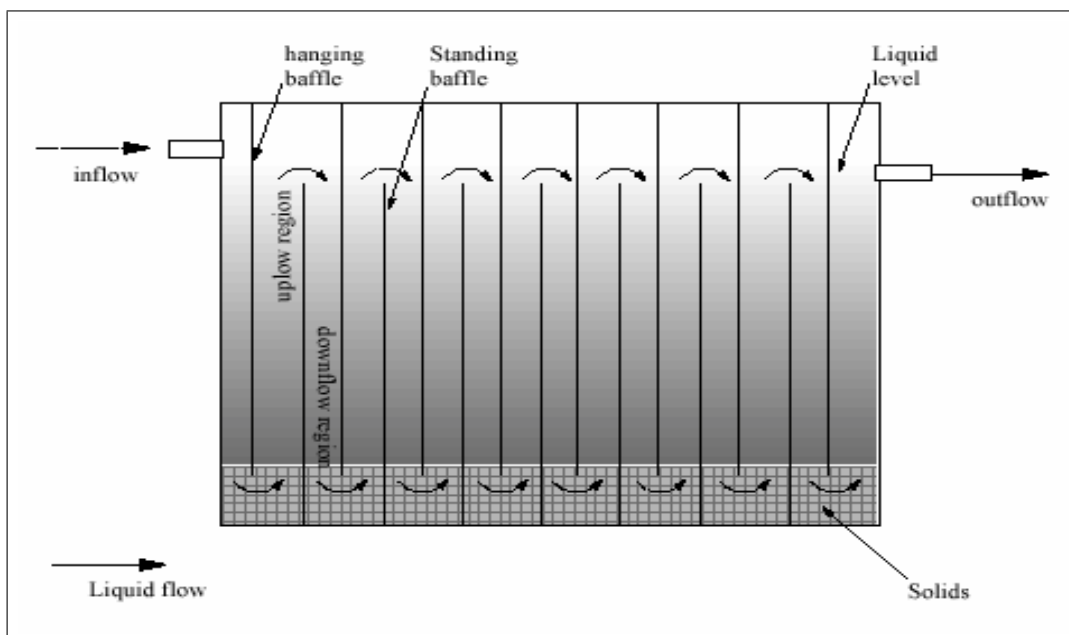

**Figure 1.2:** A simple plan of an ABR, showing water flow patterns (Foxon et al., 2001).

Global research into the ABR has shown that it has the ability to treat high strength organic loads, and has consistently high Chemical Oxygen Demand (COD) removal. It does not require external power and meets the other requirements for a sanitation alternative, namely:

- It is a low cost alternative.
- The ABR has a reduced size and is transportable.
- The design is for a closed system which is protected from the elements.
- It requires low level maintenance.
- It can cope with varying hydraulic loads.
- The ABR has low water flow requirements and does not require water pressure for operation.
- The reactor can handle the buildup of solids.

Limitations of this alternative are that the ABR does not remove Nitrogen or Phosphorous compounds and the removal of pathogens is inadequate when compared to most water quality discharge standards.

## 1.5 Aim and Objectives

This study forms part of a larger Water Research Commission (WRC) Project, conducted by the Pollution Research Group at the University of KwaZulu-Natal, which investigated "the anaerobic baffled reactor for sanitation in dense peri-urban areas". The objectives of the research were (Foxon et al., 2005):

1. To provide an appropriate sanitation system for application in peri-urban areas through scientific and engineering support to the KwaZulu-Natal Business Partners for Development water and sanitation project.
2. To develop an anaerobic baffled reactor for use in pre-treating sewage from peri-urban areas.
3. To monitor the performance of the ABR in a peri-urban area.
4. To undertake pilot studies of the ABR at a wastewater treatment plant.

5. To gain scientific knowledge on the fluid mechanics and microbiology of the ABR for the pre-treatment of sewage from peri-urban areas.
6. To contribute to the development and validation of a computer model for anaerobic digestion.

The project focused on the microbiological and biochemical performance of the reactor under relatively controlled conditions at a wastewater treatment plant. The ABR was initially commissioned at the Umbilo Wastewater Treatment Plant which treats both domestic and industrial wastewater. The ABR was later moved to the Kingsburgh Wastewater Treatment Plant, which treats domestic wastewater only, as the Kingsburgh wastewater was considered more representative of the type of wastewater intended for treatment by the ABR.

The author worked on the project team as a research assistant, with the function of ongoing maintenance and monitoring of the pilot ABR at the Kingsburgh Wastewater Treatment Plant, as well as biweekly analysis of COD and Total Solids.

The WRC study was completed in 2005, and all findings (including those made by the author as part of the project team) have been compiled and published in the final report "Evaluation of the Anaerobic Baffled Reactor for Sanitation in Dense Peri-urban Settlements" (Foxon et al., 2005).

### **1.5.1 Operational Performance of the ABR**

The aim of this MSc study was to investigate the performance of the ABR as an alternative to sanitation in peri-urban communities. It was anticipated that treatment of wastewater by the ABR, would result in effluent that was of an irrigation standard, in terms of Volume 4 of the DWA Water Quality Guidelines (Department of Water Affairs, 1996).

Through analysis of the water quality of both the influent (which for the purposes of this study was raw sewage from the Kingsburgh wastewater treatment facility) and the treated effluent from the ABR, this investigation monitored the performance of the ABR to determine whether the effluent could meet the desired water quality standards.



This study consists of the following:

1. Bi-weekly monitoring of the ABR, including sampling of the influent and effluent and recording flow rates and upset conditions.
2. Analysis of samples for major indicators of water quality including, Solids, Chemical Oxygen Demand (COD), pH, Nitrogen, Phosphorous and microbial pathogens.
3. Analysis of collected data in order to record its progress and to determine the performance of the ABR as a treatment alternative.

---

---

## CHAPTER 2

---

# LITERATURE REVIEW

### 2.1 Sanitation in a South African Context

The Constitution of the Republic of South Africa promotes the provision of sanitation to all South African citizens as a basic human right. South Africa is one of the few countries in the world that includes the provision of water and sanitation as basic human rights (World Bank, 2002).

Historically, only certain population sectors were provided access to tap water and waterborne sanitation within their own houses. Since 1994, the South African government has endeavoured to increase sanitation service provision through the National Water and Sanitation Programme. The aims of this programme are (World Bank, 2002):

1. The policy and legislative framework within which the national programme has been implemented.
2. The capital works programme which, between 1994 and 2002, provided infrastructure intended to meet the basic needs of over seven million people.
3. The 'free basic water' policy, which aims to ensure that affordability is not a barrier for access to safe water.
4. Devolution of responsibility from the national government to local government, acting through community-based approaches.

In terms of sanitation, this programme aims to eliminate the sanitation backlog by 2010 and eradicate the bucket system by 2007 (StatsSA, 2009). In July 2008, it was reported that the national average percentage of households which had no access to a toilet or used the bucket system had been reduced to 7.7%. The Free State, Western Cape, Northern Cape and Limpopo Provinces are areas of concern as there are still a large number of households (more than 10% of the households in each province) still using the bucket system.

At present more than 67% of households in the country have access to sanitation at a basic level of service as a minimum (ie. a ventilated improved latrine per household).

As a result of recent statistics, the goal to eradicate the basic sanitation services backlog has been extended to 2014 (Department of Water Affairs, 2009).

### 2.1.1 Current Sanitation Alternatives in Rural Areas

According to the *National Sanitation Policy* (2002) white paper, the Basic Level of Service for a single household is a "Ventilated Improved Pit (VIP) toilet in a variety of forms, or its equivalent, as long as it meets minimum requirements in terms of cost, sturdiness, health benefits and environmental impact". In addition to this Basic Level of Service, a programme of education about correct hygiene practices should also be provided on a continual basis.

Waterborne sanitation is generally used for sewage treatment in urban areas and dry sanitation technologies in rural areas. The following sanitation technologies are employed in South Africa (DWA National Sanitation Programme Unit, 2008):

1. **VIP Toilets:** These low cost toilets are highly suitable for areas without household water connections. The VIP toilet consists of a small above-ground structure in which the toilet pedestal is constructed over a pit which collects the waste. The pit is often constructed of porous material to allow moisture to seep out, and a vent with a fly screen is incorporated into the design to promote air flow out of the pit. The pit requires that the waste is manually emptied at regular intervals.

This alternative can be modified into a double VIP toilet, whereby two pits and two vents are alternately used under one above-ground structure. VIP toilets are designed to handle only human waste and cannot be used for treatment or storage of greywater.

2. **Urine Diversion Toilet:** This intermediate cost alternative is also appropriate for areas without household water connections. The toilet consists of a raised structure with a toilet that is designed to separate solid waste from urine. The solid material falls into a pit at ground level, which can be accessed through an opening at the top of the pit construct. The technology requires that the solid waste is turned regularly to promote the composting process. The solid waste must be removed on a regular basis. The urine from the toilet is diverted to a separate collection pot or to a soakaway area. Urine diversion toilets are designed to handle only human waste and cannot be used for treatment or storage of greywater. This technology is environmentally sustainable.
3. **Aqua-Privy:** This type of toilet is also referred to as a Lo-Flo Digester, and is considered an intermediate cost alternative. It is suitable for households without reliable water connections. The Aqua-Privy consists of an above-ground structure which includes a toilet with a flush option. The down pipe from the toilet leads to a water tight pit, in which the waste separates out into a sludge layer and volume of liquid. The down pipe is positioned, such that it is always below the surface of the liquid layer, but above the sludge layer. An overflow pipe directs the liquid to a soakaway, and this technology requires that sludge is removed on a regular basis to prevent buildup. The Aqua-Privy can handle small amounts of greywater and is considered as an environmentally sustainable alternative.
4. **Waterborne Sanitation:** The in-house flush toilets in residential units in urban areas are linked to waterborne sewer systems which remove greywater and human waste, or blackwater, from the household and associated property. The wastewater is transported through a system of pipes, and where necessary pumped, to a wastewater treatment plant. This type of sanitation requires high volumes of water and is associated with high costs of construction, operation and maintenance. This technology has a large environmental footprint, and poses an environmental risk if not properly maintained.

5. **Septic Tank:** This is also a high cost technology whereby an intermediate step is included in the waterborne sanitation process included above. Household wastewater is directed to an underground septic tank, usually on the same property. The waste separates into a liquid layer and a sludge bed, and an overflow pipe directs some liquid waste to a soakaway and some to the sewer system and on to the wastewater treatment plant. The sludge from the septic tank must be emptied at regular intervals. This technology poses an environmental risk if not properly maintained.

## 2.2 Wastewater Constituents

Wastewater treatment is the process of removing the contaminants from sewage to produce liquid effluent and a sludge component, which meets the legislative requirements for discharge to the environment or for reuse (Sincero and Sincero, 2003). Sewage is a complex mixture of wastewater and its characteristics vary in flow rate and in composition according to the type of community it originates from, local geological conditions and local water and water treatment conditions. The design and implementation of treatment technologies is dependent upon the characteristics of the pollutants or contaminants listed in Table 2.1.

Various chemical and biological treatment technologies are employed to treat different types of wastewater with the objective of removing some or all of these contaminants.

**Table 2.1:** Major contaminants of municipal sewage and the associated parameters used to quantify the degree of contamination (Civil and Environmental Engineering, University of Witwatersrand, 2003).

Contaminant	Parameter	Environmental Impact
Suspended Solids	Total Suspended Solids (TSS)	Potential for sedimentation in water bodies and depletion of Oxygen concentrations in the affected water body.
Dissolved Solids	Electrical Conductivity or Dissolved Solids (TDS)	This is specifically relevant in agriculture, where high salinity levels may effect crops or livestock.
Biodegradable Organics	Biological Oxygen Demand (BOD)	May cause Oxygen depletion in a water body which could lead to nuisance odours and potential fish kills.
Refractory Organics	Chemical Oxygen Demand (COD)	These show resistance to treatment and may accumulate in the environment, and include humic residues, detergents, phenols, cyanide, residual hormones, pharmaceuticals and pesticides.
Nutrients	Kjeldahl Nitrogen (TKN) and Total Phosphorous (P)	Excess nutrients cause eutrophication which results in Oxygen depletion, reduction in biodiversity, fish kills, nuisance odours and increased toxicity.
Pathogenic Microorganisms	Faecal coliforms, viruses and helminth eggs	Pathogens transmit communicable waterborne diseases, such as cholera, diarrhoea, hepatitis.
Toxic compounds	Indicator Organisms or specific tests for a compound	These may have serious consequences in the environment, such as bioaccumulation of heavy metals.

## 2.3 Introduction to Anaerobic Digestion

Anaerobic digestion is a multistage biochemical process, which is used to digest many different types of organic material. The process can be divided into three major steps (Bailey and Ollis, 1986):

- **Hydrolysis** - converts complex organics to less complex, soluble organic compounds by extracellular enzymatic hydrolysis. Substances such as proteins, cellulose and fats are hydrolysed in this step.
- **Acidogenesis** (acid production) - the products from the first step are converted to Propionic Acid, Hydrogen, Carbon Dioxide, and other low weight organic acids, by facultative and anaerobic micro-organisms.
- **Methanogenesis** (Methane formation) - this is carried out by two types of methanogens, the first of which converts Hydrogen and Carbon Dioxide to Methane, and the second (acetoclastic bacteria) of which converts Acetate to Methane and Bicarbonate. These bacteria are responsible for more than 70% of total COD reduction.

## 2.4 Overview of the Anaerobic Baffled Reactor

Biological processes are usually used for treatment of both domestic and industrial wastewaters, as they are more cost effective than chemical methods. Aerobic processes are generally preferred for wastewater treatment, however ongoing research into anaerobic digestion over the past 25 years, has increased the general understanding of anaerobic microbial activity and allowed for significant developments in reactor design (Langenhoff and Stuckey, 2000).

### 2.4.1 Anaerobic Baffled Reactor Designs

The ABR design was developed in the early 1980's, and comprises a series of baffles, which force wastewater under and over these baffles as it flows from the inlet to the out-

let. Solids settle in the upflow region of each compartment resulting in the development of sludge beds (Barber and Stuckey, 1999). Microbial populations develop within the sludge layers, rising and settling due to the flow characteristics within the reactor (Foxon et al., 2004). Figure 2.1 shows the original design of the ABR (Barber and Stuckey, 1999).

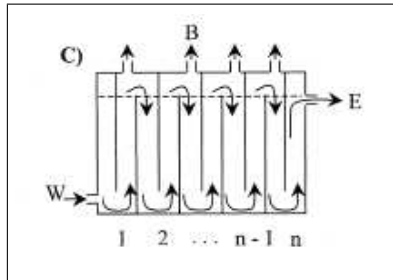

**Figure 2.1:** Original design for the anaerobic baffled reactor.

In order to improve the efficiency and performance of the reactor many modifications have been made, the primary motivation being further capacity for solids retention (Barber and Stuckey, 1999). Other changes in design have been driven by the requirement to treat difficult wastewaters with high solids content or organic loading, or to reduce capital costs. Figure 2.2 shows a few of the major modifications made to the ABR since the 1980s, which include the following (Barber and Stuckey, 1999):

- Vertical baffles were included to increase solids retention and allow for increased contact time with sludge beds and methanogen populations.
- The downflow chambers were designed to be narrower to encourage cell retention in upflow compartments.
- The baffles were modified with slanted edges to direct the flow toward the centre of the compartment to encourage mixing.
- The ABR has been reconfigured as a settling chamber with suitably placed baffles to enhance solids retention.
- In some ABRs, packing has been positioned at top of each chamber to prevent the washout of solids.
- The ABR has been designed with separate gas chambers for the control of gas measurements. This also enhances the stability of the reactor.



- The first chamber has been enlarged in some cases which increases the treatability of wastewater containing high solids wastewater.

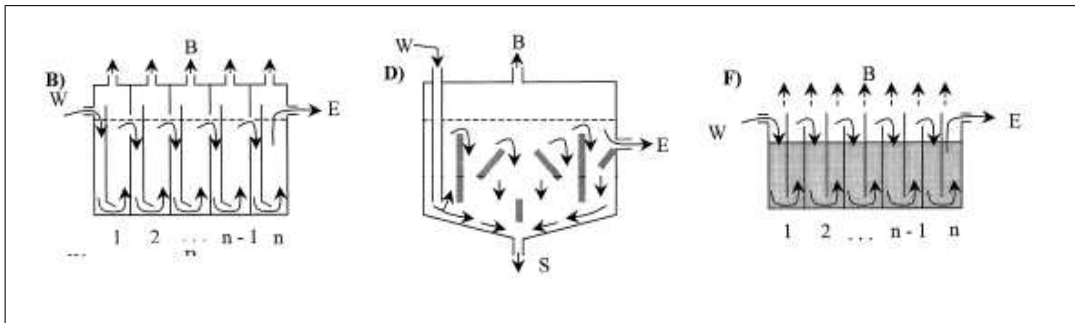

**Figure 2.2:** Modifications to the Anaerobic Baffled Reactor (Barber and Stuckey, 1999).

The selection of a reactor design is dependent on the characteristics of the wastewater being treated. The ABR investigated in this study, as shown in Figure 2.3, has a standard design with inclined edges at the lower ends of the hanging baffles, which routes the flow toward the centre of the upflow compartment to enhance mixing.

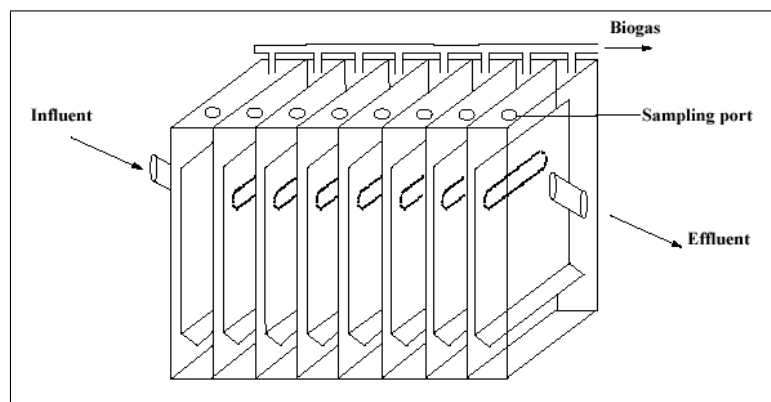

**Figure 2.3:** Schematic diagram of the ABR design for this project (Foxon et al., 2004).

Recently, a study was conducted using an anaerobic baffled reactor with four compartments; each compartment was fed untreated influent, with an influent ratio of 4:3:2:1 in each compartment. Relative to the original configuration of single influent feed into the first chamber, the reactor showed increased COD removal (Peng et al., 2008).

### 2.4.2 Basic Microbiology of the ABR

Various profiles of anaerobic populations develop in each compartment of the ABR, which is dependent on the type of wastewater, amount of substrate present in the wastewater, pH and temperature (Barber and Stuckey, 1999).

The front compartments of the ABR constitute the acidification zone, in which fast-growing, acid-producing micro-organisms that prefer high substrate levels and low pH will dominate (Barber and Stuckey, 1999). There is a shift towards the end compartments of the ABR where slower-growing scavengers, which prefer the higher pH, are found. Throughout the reactor, different species of methanogens flourish, but this is dependent on the concentration of acetate produced in the middle phase of anaerobic digestion.

One of the most significant advantages of the ABR is the ability to separate acidogenesis and methanogenesis horizontally through the reactor. This allows the ABR to behave as a two-phase system without the associated control problems and high costs (Weiland and Rozzi, 1991). Two-phase operation can increase acidogenic and methanogenic activity by a factor of up to four (Barber and Stuckey, 1999).

There has been some investigation into recycling of the effluent back into the ABR. This has been shown to reduce removal efficiencies because the reactor becomes highly mixed (Barber and Stuckey, 1999). Mixing caused by recycling has been shown to cause single phase digestion within the reactor, such that the benefits from the separation of acidogenic and methanogenic phases are partially lost. This results in scavenging methanogenic bacteria moving to the front of the reactor where they become inactive due to harsh conditions of high solids and organics levels, high Hydrogen partial pressure and low pH, while the methanogens and poorly acid producing microorganisms move towards the back of the reactor begin to starve as less complex organic substrate will be available (Barber and Stuckey, 1999).

### 2.4.3 Startup

Barber and Stuckey (1999) explain that the purpose of a startup period is to develop the

most appropriate microbial populations for the waste stream being treated. It is recommended that initial loading rates should be low so that slow growing micro-organisms are not outcompeted, and that both gas and liquid upflow velocities are low so that flocculent and granular growth is encouraged. Once the biomass has been established, reactor operation is quite stable. To prevent overloading and to stimulate startup, the reactor can be seeded with activated sludge containing appropriate microbial cultures.

Greater reactor stability and performance can be achieved when the ABR is started up with a longer hydraulic retention time (such as 80 hours), which can be reduced incrementally when the substrate concentration remains constant and therefore no loading variability (Barber and Stuckey, 1997). This is attributed to solids accumulation and promotion of methanogenic populations.

#### **2.4.4 Wastewater Treatment**

Anaerobic digestion within the ABR causes a removal of organic compounds from the wastewater. Treatment of various wastewaters has shown between 60% and 97% COD removal (Barber and Stuckey, 1999). There is also a considerable reduction in Total Suspended Solids (TSS) and inactivation of pathogens. There is little removal of Phosphorous and Nitrogen, since these require aerobic treatment processes or additional modifications to the ABR to include an aerobic compartment. Ammonia concentrations have been found to increase, as a result of the breakdown of Organic Nitrogen by anaerobic bacteria (Dama et al., 2002).

The ABR has been successful in the treatment of particulate organic material. Inert solids that enter the reactor, however, are not degraded but accumulate in the first compartment (Foxon et al., 2004). Less dense solids float on the surface of the first compartment and form a scum layer. The remainder of the solids are retained at the bottom of the first compartment. Solids with a similar density to water may not settle in the first or any compartment and would be transported through the reactor and discharged with the effluent. Therefore the ability of the ABR to handle solids is associated with the feed line or the first compartment. This can be managed by the addition of a screening unit on the feed line or by appropriate sizing and design of the first compartment for solids

removal (Foxon et al., 2004).

The optimal pH for anaerobic digestion ranges between 6.5 and 8.2 (Speece, 1996). pH values outside of this range limit microbial activity and therefore anaerobic digestion.

Speece (1996) recommends that alkalinity concentrations of anaerobic treatment systems are sufficiently high to provide a "reserve alkalinity" that may neutralise additional acids produced during fermentation. This reserve alkalinity buffers the operating pH, such that the pH remains above 6.2, to prevent inhibition of microbes below a pH range of 6.2–6.5.

#### **2.4.5 Suitability in a Peri-Urban Community**

The use of the ABR for wastewater treatment is dependent on an existing water supply, and is intended for communities without a formal sanitation system. It is also a suitable alternative for on-site sanitation in areas with steep topography and limited available space. Other potential applications for the ABR include an integrated treatment system for schools and treatment of brewery waste (Foxon et al., 2004).

The use of effluent from the ABR for agriculture purposes allows for irrigation with water with high nutrient levels, which acts as a substitute for fertiliser products. This can have a beneficial impact on agriculture and creation of informal employment opportunities.

A field-scale study was conducted to evaluate the effect of plants irrigated with ABR effluent (Pillay et al., 2005). The results indicated that the effluent has no detrimental effects on plant growth, however due to the high pathogen loads, there is a health risk of microbial and viral infections to communities.

There are three main risks associated with irrigation using pathogen-contaminated water (Foxon et al., 2004):

- Contamination of surface and ground water resources, through direct discharge of irrigation water or run-off from the site.

- Agricultural workers may be exposed to infection by pathogens in the soil, including bacterial and viral infections and nematode worms (e.g. hookworm).
- Any person who may consume or handle agricultural products irrigated with wastewater or effluent may be exposed to infection by viable pathogens present on the product.

A further consideration is that low-income communities in KwaZulu-Natal have little cultural tolerance for the handling of waste matter (Foxon et al., 2004). As a result, local municipal authorities are cautious of sanitation technologies that require active community participation. It is therefore a possibility that there will be little community acceptance of the ABR unless the community is engaged and specific people are trained to maintain and manage the ABR and the necessary screens for solids screening.

---

---

## CHAPTER 3

---

# MATERIALS AND METHODS

### 3.1 Equipment

#### 3.1.1 Setup of the Anaerobic Baffled Reactor at Kingsburgh Wastewater Treatment Works

The pilot reactor used for this study was constructed from mild steel at the University of KwaZulu-Natal, with the dimensions 3 m x 1 m x 1.2 m; giving it a total volume of 3000 l and an internal headspace of 600 l. Sampling ports for each compartment were included along the top and on one side of the reactor. It was set up at the Kingsburgh Wastewater Treatment Works.

A submersible pump was positioned in the raw sewage channel (post grit removal) at the head of the works, and was used to pump raw wastewater to the ABR, see Figure 3.1a. It was placed inside a washing basket, which was intended to act as a primary screen and prevent larger objects such as strings, braids and newspaper clumps from clogging the pump, but the impeller still required routine cleaning. For the purpose of this study, it was replaced with a larger, more robust pump, which was necessary to cope with the load and remaining solid matter in the feed as well as to keep the feed flow more constant. However, the flow was significantly higher than the desired flow rate for the ABR. Hence, a large splitter box was constructed and positioned above the inlet, shown in Figure 3.1b, to divert approximately 90% of the flow back into the channel.



**Figure 3.1:** (a) A photograph of the pump used to feed wastewater to the ABR and (b) The feed and overflow pipes, and the splitter box above.

The flow rate of the influent from the feed box to the to the ABR was regulated by a Programmable Logic Controller (PLC); which used a Proportional-Integral (PI) algorithm that fed back from an electronic flow meter positioned at the outlet, to a feed bypass valve at the inlet (Foxon et al., 2004). This allowed for a relatively constant flow of 1.6 l/min to the ABR, where the unused feed overflowed back into the channel.

The reactor was originally seeded with digester sludge in 2002, and was then used to treat Kingsburgh wastewater at higher flow rates, for approximately a year and a half prior to the commencement of this study. As a result the sludge beds were already well established at start-up.

### 3.1.2 Limitations and Problem Solving

Start-up was delayed for several months as the original pump stopped functioning; however a new, larger pump was selected, which would reduce blockages, thereby reducing down time of the ABR. The new pump could pump ten times the feed to the ABR, and consequently a new splitter box to divert the majority of the feed was designed, and

constructed atop the ABR, as shown in Figure 3.1b.

Shortly after start-up, the pump continually tripped, resulting in little to no feed to the ABR. An electrical fault was identified in the major underground cables between the ABR mains and the pump, as well as a faulty plug-point. The electrical setup was rewired with larger cables and the plug-point was replaced. This resolved the issue for the duration of the project.

At the request of Pollution Research Group (PRG), the Kingsburgh Wastewater Treatment Plant staff began to check the ABR three times daily, and reset the pump when it tripped, record daily flow data and alert those responsible in case of problems. This additional help allowed less frequent traveling to the Kingsburgh Works, reduced ABR down time, and allowed better overall monitoring of the ABR, resulting in the solving of major problems with less delay.

Thereafter, there were few major incidents which inhibited the operation of the ABR. Table 3.1 indicates when the incidents occurred, the problem encountered and how it was resolved.



**Table 3.1:** Major incidents which resulted in ABR downtime.

Day	Problem Encountered	Action Taken
20	Pump tripped - large obstruction in impeller. No supervision over the long weekend.	Pump cleaned and restarted.
72–85	Continual tripping due to floater mechanism (prevent pump operation unless submerged - preventing overheating) trapped in a downward position.	Floater repositioned.
96	ABR gas vents clogged, creating an air blockage and preventing flow through the reactor.	Vents unclogged.
120	Pump tripped due to floater trapped in downward position.	Floater repositioned.
130	Pump tripped due to floater trapped in downward position.	Floater repositioned and cable tied in place.
146	Pump tripped, not restarted for several days.	Pump cleaned and restarted.
181–191	Blockage above pump in feed pipes to ABR. Much difficulty encountered in finding where the blockage occurred.	Pipes cut and blockage flushed out.

## 3.2 Analyses

### 3.2.1 Chemical Analyses

Anaerobic digestion converts organic matter to Carbon Dioxide (CO<sub>2</sub>) and Methane (CH<sub>4</sub>) through a series of biochemical processes (Bailey and Ollis, 1986); this conversion results in COD removal from the liquid phase. As a result total and soluble COD, as well as percentage solids removal, was analysed at regular intervals to monitor the performance of the reactor.

Samples were collected for analysis at least once each week during the period of study; grab samples were collected from the reactor feed box (influent) and from the outlet

(effluent). All samples were transported on ice in sterile glass sample bottles, stored at 4 °C, and analysed within 48 hours of collection.

Several parameters were analysed for, which either indicated the performance of the ABR, such as COD and Solids, or were indicative of operational problems, such as alkalinity. Table 3.2 lists the parameter analysed and the reason behind its selection.

### **Chemical Oxygen Demand**

COD is used as a measure of the Oxygen equivalent of the organic matter of a sample that is susceptible to oxidation by a strong chemical oxidant. For samples from a specific source, COD can be related empirically to Biochemical Oxygen Demand (BOD), organic Carbon or organic matter. BOD measures the Oxygen required for the biochemical degradation of the (carbonaceous) organic material and the Oxygen used to oxidize inorganic materials such as ferrous iron, sulphides, reduced forms of Nitrogen and sulphur.

The COD test is used to determine the content of organic matter in the sample in terms of Oxygen equivalent (American Public Health Association, 1985). Dichromate acts as a strong oxidising agent in a wide variety of samples and as a result, the Dichromate reflux method is the most commonly used procedure. When a mixture of sample wastewater, Sulphuric Acid and Potassium Dichromate ( $K_2O_2Cr_7$ ) is refluxed, 95–100% of the organic matter is oxidised. After digestion, the left over unreduced  $K_2O_2Cr_7$  is titrated against Ferrous Ammonium Sulphate (FAS) to determine the amount of  $K_2O_2Cr_7$  that was consumed. This is then used to calculate the Oxygen equivalent of organic matter of the sample.

The Dichromate reflux method can be used to determine total COD using the open reflux method, or soluble COD content, using the closed reflux method.

The samples were either analysed on the day of collection, or refrigerated at 4 °C and analysed the following day. COD was measured according to the procedure set out in American Public Health Association (1985). The open reflux method was used to determine the total COD of unfiltered samples of the influent and effluent. Further samples

**Table 3.2:** Parameter analysed and it's importance to the operation of the ABR.

Parameter	Importance
COD	A measure of the Oxygen equivalent of the organic matter, COD is used as an indication of the amount of organic matter present in the sample.
Solids	Suspended particles or dissolved matter in water or wastewater are used as an indicator of reduced water quality.
pH	Methanogens prefer nearly neutral pH conditions with a generally accepted optimum range of 6.5 to 8.2.
Alkalinity	The alkalinity of surface water gives an indication of the concentration of Carbonate, Bicarbonate and Hydroxide content. The alkalinity is also used to determine whether the system is sufficiently buffered.
Phosphates	Condensed Phosphates are a major constituent of commercial cleaning products. Organic Phosphates are formed primarily by biological processes. It was anticipated that there would be no removal of Phosphates, due to the anaerobic nature of the ABR.
TKN	Organic Nitrogen, Nitrates and Nitrites are constituents of the Nitrogen Cycle. It was anticipated that there would be no removal of Nitrogen compounds, due to the anaerobic nature of the ABR.
Microbes	Faecal coliforms are sampled and analysed as indicators of the presence of other pathogenic microbes, which may have a risk to human health.

from the influent and effluent were filtered with 0.45  $\mu\text{m}$  filters and digested using the closed reflux method to determine the soluble COD content. Three replicates of each sample were analysed.

### **Total Solids and Suspended Solids**

“Total Solids” refers to any suspended or dissolved matter in water or wastewater (American Public Health Association, 1985), and large amounts of solids in a sample indicate a much reduced water quality. Measurement of solids is essential for control of treatment processes and compliance with effluent regulations. “Total solids” pertains to all the matter present in the sample, after evaporation of that sample, and includes total suspended solids (those solids which may be filtered out) and dissolved solids (those solids that are in solution and pass through the filter).

The samples were either analysed on the day of collection, or refrigerated at 4 °C and analysed the following day. Total and Suspended Solids were measured according to the procedure set out in Standard Methods (American Public Health Association, 1985). The influent and effluent used for suspended solids was filtered and the filtrate was decanted to crucibles; while for total solids, the unfiltered influent and effluent samples were decanted to crucibles. All samples were dried in a drying oven. Two replicates of each sample were analysed.

### **pH and Alkalinity**

pH is a measure of the acidity or basicity of a solution (American Public Health Association, 1985). It is defined by the activity of dissolved Hydrogen ions ( $H^+$ ). Methanogens prefer neutral pH conditions with an optimum range of 6.5 to 8.2 and conditions outside of this range reduce the microbial rate of Methane production significantly. Low alkalinity in a poorly buffered anaerobic system can lead to pH values drifting outside of the optimal range resulting in instability (Speece, 1996).

Low alkalinity in a poorly buffered system can lead to pH values drifting outside of the optimal range resulting in instability.

pH measurements were taken and recorded on site, using a pH meter. These measurements were recorded by various members of the project team during the study period.

Alkalinity is a measure of the capacity of a solution to neutralise acid. The alkalinity of

domestic wastewater gives an indication of the concentrations of Carbonate, Bicarbonate and Hydroxide within the wastewater (American Public Health Association, 1985).

In an anaerobic system, the more dilute the wastewater, the lower the potential to generate alkalinity. The function of alkalinity in the anaerobic process is to buffer the Carbon Dioxide acidity; therefore an alkalinity of 2000 mg/l is required to buffer the system at pH 7 (Speece, 1996).

Samples of 50 ml were collected in glass vials, transported on ice and analysed on the day of collection. One replicate of each sample was analysed according to the procedure set out in Standard Methods (American Public Health Association, 1985).

*(Analyses for Alkalinity were conducted by Divesha Moodley at the School of Chemistry, UKZN)*

### **Phosphates**

Phosphorous occurs in natural waters and in wastewaters as Phosphates. These are classified into Orthophosphates, condensed Phosphate (Polyphosphates) and organically bound Phosphates. The Phosphates occur in solution, particles, organisms or detritus material. The different forms of Phosphates arise from a variety of sources, including water treatment, and laundry or cleaning detergents. Condensed Phosphates are a major constituent of commercial cleaning products. Organic Phosphates are formed primarily by biological processes, including human wastes and food residues, or biological treatment processes.

Phosphorous concentrations are determined in two general steps (American Public Health Association, 1985):

1. Conversion of Phosphorous to dissolved Orthophosphate.
2. Colorimetric determination of dissolved Orthophosphates.

Only seven Phosphate samples were taken during the study period. These samples were stored on ice and analysed on the day of collection, according to the procedures set out in Standard Methods (American Public Health Association, 1985).

(Analyses for Phosphates were conducted by Metrolabs in Durban)

### Total Kjeldahl Nitrogen and Ammonia

In water and wastewater, the Nitrogen compounds that are of significance are as follows.

- Organic Nitrogen,  $N_2$
- Nitrate,  $NO_3$
- Nitrite,  $NO_2$
- Ammonia,  $NH_3$

These are components of the Nitrogen Cycle and are biochemically converted from one to the next under appropriate conditions.

Organic Nitrogen includes natural materials (proteins, peptides, nucleic acids, urea) and many synthetic organic materials. Organic Nitrogen concentrations can be more than 20 mg/l in wastewater. Nitrates are found in trace quantities in surface waters, and up to 30 mg/l in treatment plants using biological processes to remove Nitrogen from wastewater. Ammonia is naturally present in wastewater, as it is produced by the deamination of compounds containing Organic Nitrogen, and through the hydrolysis of urea. It is found in concentrations of more than 30 mg/l in wastewater.

The Kjeldahl method is the universally accepted method for analysis of Nitrogen content, as it is the only test that can cope with the variety of conditions typical of wastewater samples. Total Kjeldahl Nitrogen (TKN) is the sum of Organic Nitrogen, Ammonia and Ammonium, and is determined through a 2-step reaction, namely, distillation and a back titration. Often, Ammonia content is determined, then subtracted from the TKN to determine the Organic Nitrogen content, however this was not performed during this study. TKN was analysed for the purposes of comparison with the DWA Water Quality Guidelines.

Eight *ad hoc* samples were taken from the influent and effluent of the ABR to determine TKN, using the Kjeldahl method, according to the procedures set out in American Public

Health Association (1985).

*(Analyses for TKN and Ammonia were conducted by Metrolabs in Durban)*

### 3.2.2 Microbial Analyses

During the period of study, grab samples were collected from the reactor feed box (influent) and at the outlet (effluent). All samples were transported and stored at 4 °C, in sterile glass sample bottles, and analysed within 24 hours of collection.

*(All microbial analyses and associated statistical analyses were performed by Sudhir Pillay at the School of Life and Environmental Sciences at UKZN)*

#### Coliforms

Enumerated coliforms included total coliforms and *Escherichia coli* (*E. coli*). Coliforms were measured using the membrane filtration technique (American Public Health Association, 1985). Grab samples were serially diluted and filtered through a gridded 0.45 µm membrane filter. Filters were aseptically placed on Chromocult Coliform Agar (Merck), and incubated at 35 °C for 18–24 hours. *E. coli* colonies and total coliforms were identified by colour (Sudhir Pillay, personal communication, 2004).

#### Statistical Analyses

Statistical analyses were performed on the results of the microbial counts to determine whether any reduction in pathogen counts were significant. The Statistical Package for the Social Sciences (SPSS) is one of the most commonly used software packages for statistical analysis, and is employed in market research, health science, surveys and general scientific research (Wikipedia, 2009). The SPSS software was used during this study to determine whether there were significant differences between the faecal coliforms in the influent and effluent samples. SPSS was recently rebranded and now called the Predictive Analytics Software (PASW).

Students t-tests were employed to analyse the results of the microbial counts. Students t-tests are used to compare the results of two different samples and construct a confidence interval; the t-test determines a probability that two populations are the same with respect to the variable tested.

### 3.3 Department of Water Affairs Water Quality Guidelines

The Water Quality Guidelines for Irrigation which are applicable to the parameters in this study are set out in Table 3.3. Total Solids, pH and Faecal Coliforms were compared to these Water Quality Guidelines to determine whether the ABR effluent is suitable for irrigation.

**Table 3.3:** DWA Water Quality Guidelines for Agricultural Water Use: Irrigation.

Criteria Constituent	Target Water Quality Range
Total Suspended Solids	0 - 50 mg/l
pH	6.8 - 8.4
Faecal Coliforms	0 - 1 <i>E.coli</i> counts /100 ml



---

---

## CHAPTER 4

---

# RESULTS

### 4.1 Startup of the Anaerobic Baffled Reactor

This study was conducted for the third operating period of the ABR at the the Kingsburgh Wastewater Treatment Plant, during 2004. The ABR had been operating on and off for two years prior to this study at the Kingsburgh plant, and the reactor contained at least 200mm of active sludge in each of its compartments. As a result COD and TSS removal were constant, suggesting that analysis for this operating period could commence.

The data presented in this section was used to determine the operational performance of the ABR. The following parameters were sampled for, and analysed to determine the extent of removal or change of each parameter. The major indicators of the performance of the ABR are COD and Total Suspended Solids; pH was also measured on site to monitor the operating condition of the ABR. Parameters analysed included:

- Chemical Oxygen Demand
- Total Solids
- Ammonia and Total Kjeldahl Nitrogen
- Phosphates
- Pathogen indicator organisms

The DWA Water Quality Guidelines for Irrigation set a Target Water Quality Range (TWQR) for the parameters applicable to this study, namely TSS, pH and coliforms. The data for these constituents was compared to the respective TWQR's, to determine whether the ABR effluent complied with the standards for irrigation quality.

#### 4.1.1 Flow and Incidents

For the 165 day operating period, April to October 2004, the hydraulic retention time of the ABR was increased to approximately 42 hours (although this varied between 40 and 44 hours). The flow to the ABR was regulated using a Programmable Logic Controller (PLC), as discussed in Section 3.1. The average flow rate for the period was 1.2 l/min. During this operating period the ABR treated a volume of 262 000 l of wastewater.

During this operating period, there were a few major incidents which interfered with the operation of the ABR, however there were no extended periods of downtime. Table 4.1 indicates the day of operation when the incidents occurred and the problem encountered. Figure 4.1 shows the cumulative flow through the ABR over the entire study period.

**Table 4.1:** Details of incidents encountered during operation of the ABR.

Day	Problem encountered
20	Pump tripped - large obstruction in impeller.
72-85	Continual tripping due to floater mechanism trapped in a downward position.
96	ABR gas vents clogged, creating an air blockage and preventing flow through the reactor.
120	Pump tripped due to floater trapped in downward position.
130	Pump tripped due to floater trapped in downward position.
146	Pump tripped, not restarted for several days.

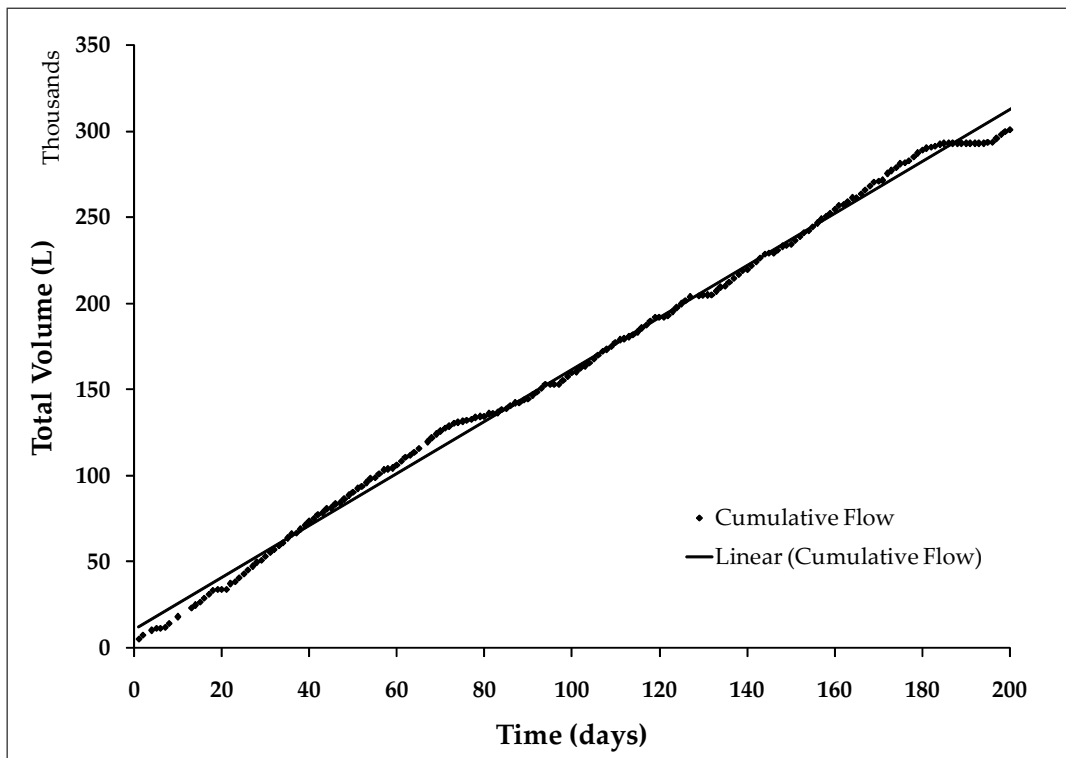

Figure 4.1: Cumulative flow for the duration of the study period.

## 4.2 Chemical Component

### 4.2.1 Chemical Oxygen Demand

Analysis of total COD from both the influent (raw domestic sewage) and ABR effluent, showed a significant removal of COD, as represented in Figure 4.2.

The COD measurements vary slightly with time; however, there is no apparent trend or correlation with operational incidents. Influent COD concentrations ranged from 360 mg/l to 930 mg/l, and much fluctuation was noted with weekly sampling. In routine maintenance and analysis of the influent wastewater, municipal data for raw domestic sewage at Kingsburgh Wastewater Treatment Plant, confirmed the ABR influent data to be accurate (although it is not included in this study).

Effluent COD values ranged from 62 mg/l to 160 mg/l. The percentage removal of COD by the ABR shows that the average reduction in COD is 83%, and removal was consistently between 78% and 90%, as indicated in Figure 4.3

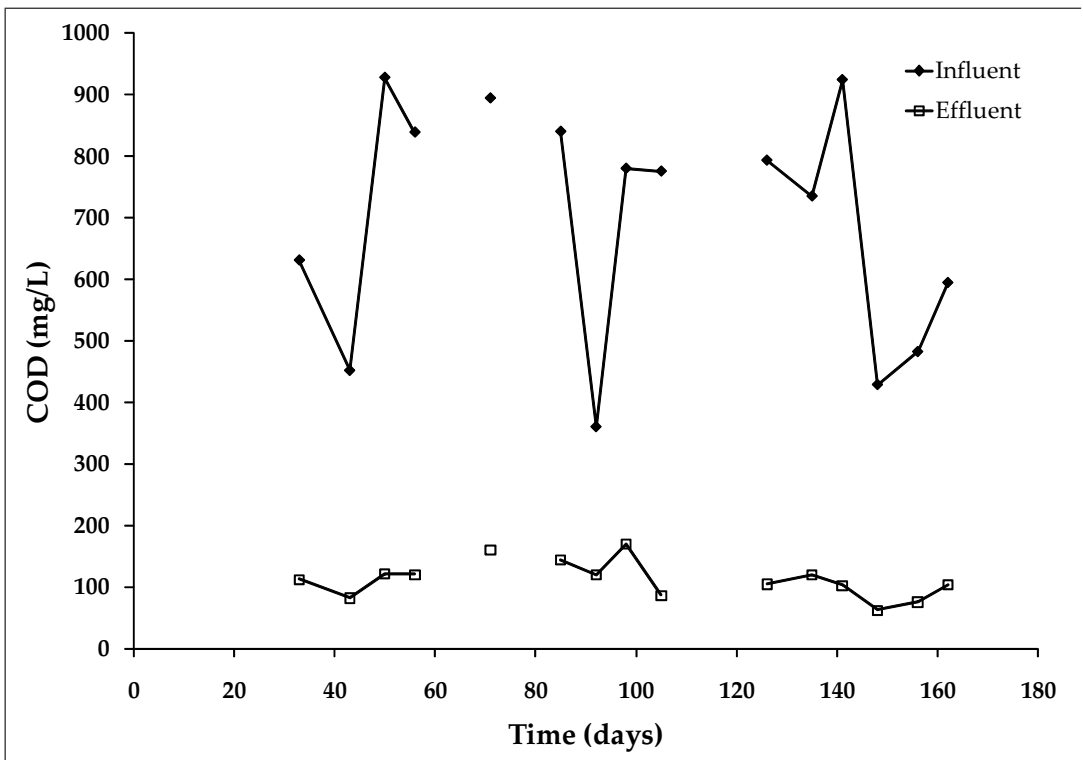

Figure 4.2: Total COD values for the period of operation.

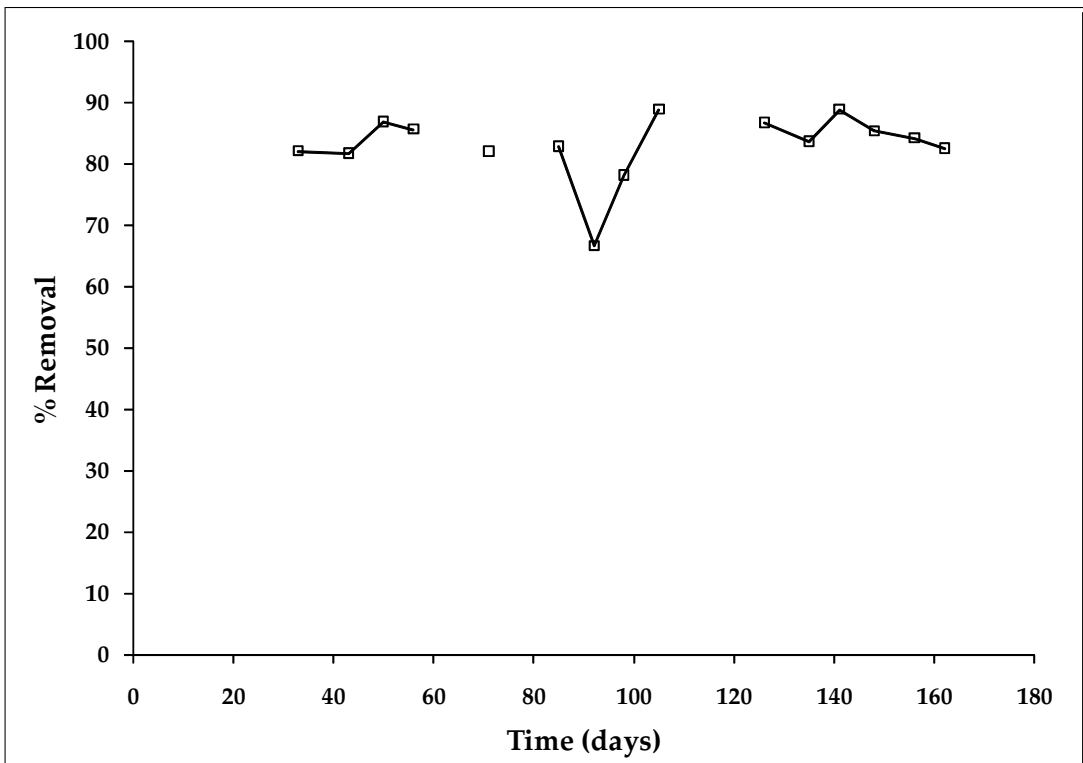
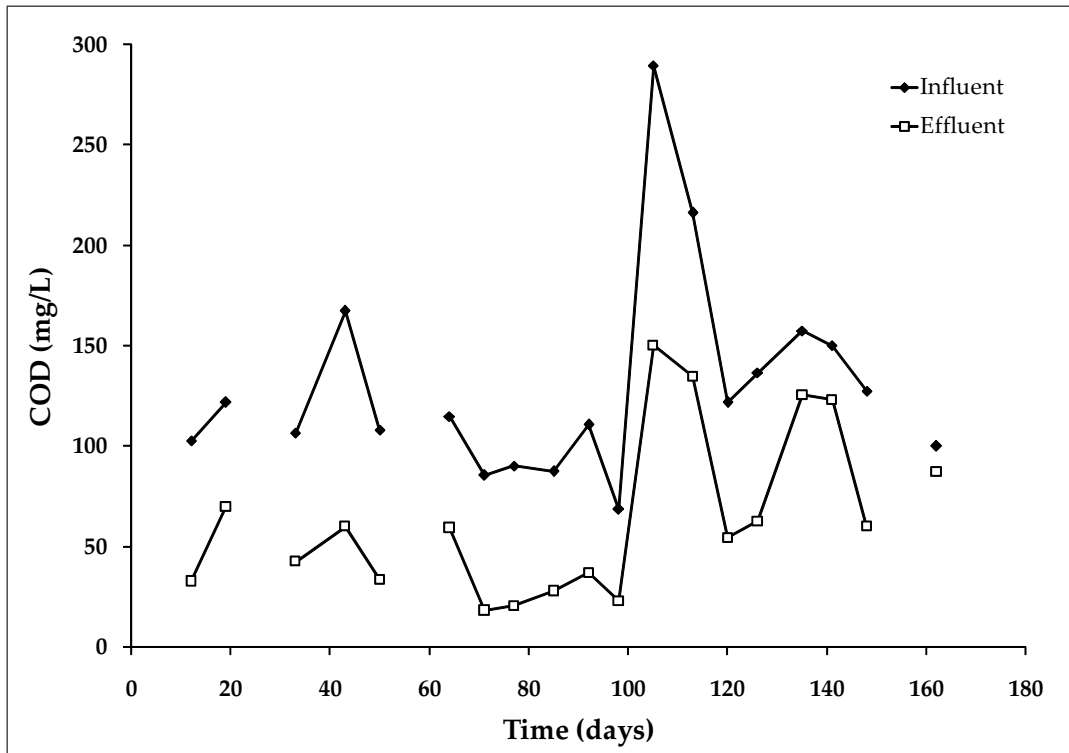

Figure 4.3: Percent removal of COD by the ABR for the duration of the study period.

Soluble COD, from both the influent and treated effluent, was also analysed. Again, the influent values varied with weekly sampling from 68 mg/l to 290 mg/l. Soluble COD data showed removal rates of between 40% and 80%, with effluent values ranging from 18 mg/l to 150 mg/l.

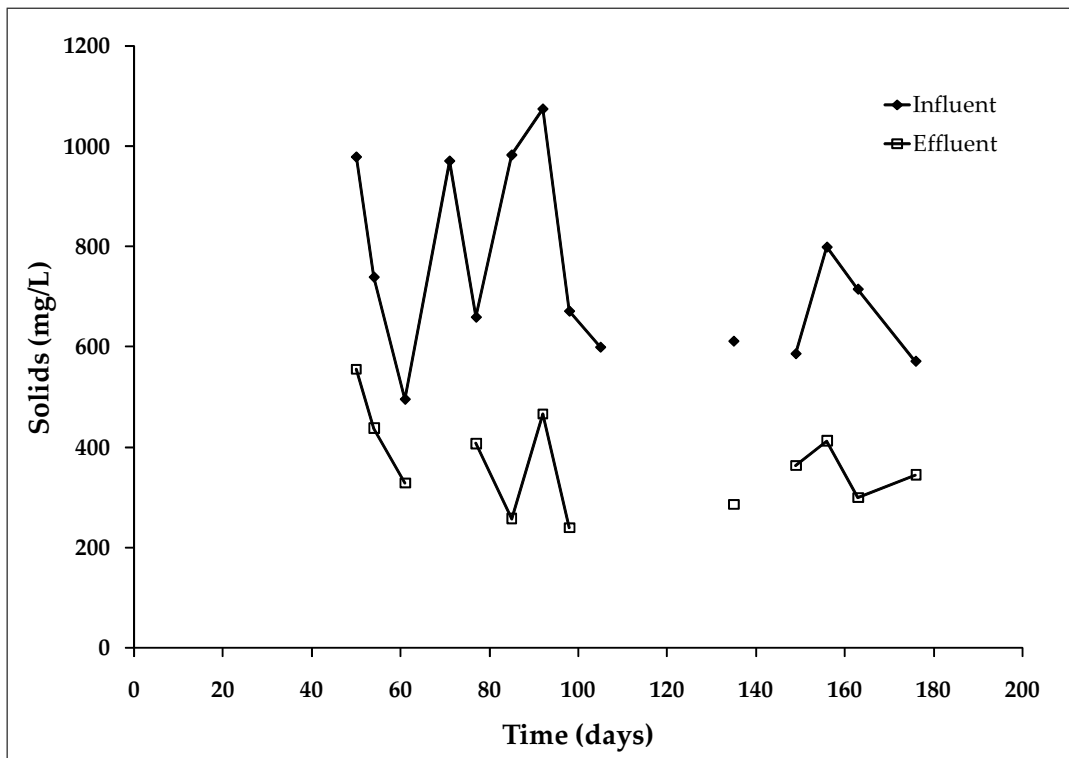

**Figure 4.4:** Soluble COD values of both the influent and effluent for the period of operation.

#### 4.2.2 Total Solids

Total solids for the influent ranged from 500 mg/l to 1 076 mg/l. Between 40% and 70% removal of total solids was attained, resulting in effluent values between 240 mg/l and 556 mg/l. Figure 4.5 shows the total solids data for both the influent and treated effluent for the study period.

Figure 4.6 shows the clarity of the ABR-treated effluent, relative to the raw sewage used as influent, giving a visual illustration of the removal of the total solids.



**Figure 4.5:** Total solids values of the influent and effluent for the period of the study.

### 4.2.3 pH and Alkalinity

On site measurements for pH ranged between 4.4 and 7.8 for the influent with an average of 7.2; and between 6.2 and 7.4 for the effluent with an average of 6.5. Influent pH measurements showed greater variability than the effluent, and the effluent pH values were consistently lower than influent pH values. This data was gathered by various members of the project team during the 6 month operating period.

Alkalinity concentrations were averaged to 256 mgCaCO<sub>3</sub>/l for the influent samples and 246 mgCaCO<sub>3</sub>/l for the effluent samples. These results were obtained from only a few samples (n=4).

### 4.2.4 Total Kjeldahl Nitrogen

TKN in the influent was found to have an average concentration of 44.6 mgN/l and an average of 37.1 mgN/l in the effluent. The students t-test (p=0.001) indicated that



**Figure 4.6:** Photograph showing the influent and the clarity of the treated effluent.

there was a statistically significant reduction in TKN. These results were obtained from 8 samples.

#### 4.2.5 Phosphates

Data collected and analysed for Phosphates ranged between 3.2 mgP/l and 32.5 mgP/l for influent. The effluent values ranged between 10.3 mgP/l and 26.2 mgP/l. Although there appears to be a slight decrease in Phosphate in the effluent, as compared to the influent, this was not considered to be a significant difference (students t-test,  $p=0.005$ ), and is attributed to the relatively few number of samples ( $n=7$ ).

## 4.3 Microbial Component

### 4.3.1 Faecal Coliforms

Results of analysis samples for *E.coli* indicated an average range of  $1 \times 10^7 - 5 \times 10^7$  cfu/100ml in the influent wastewater and an average range of  $7 \times 10^5 - 1 \times 10^7$  cfu/100ml in the ABR treated effluent. There was a significant reduction in *E. coli* (students t-test,  $p=0.000$ ) by an average of 76%. Figure 4.7 shows the *E. coli* counts for the influent and effluent samples obtained during the study period.

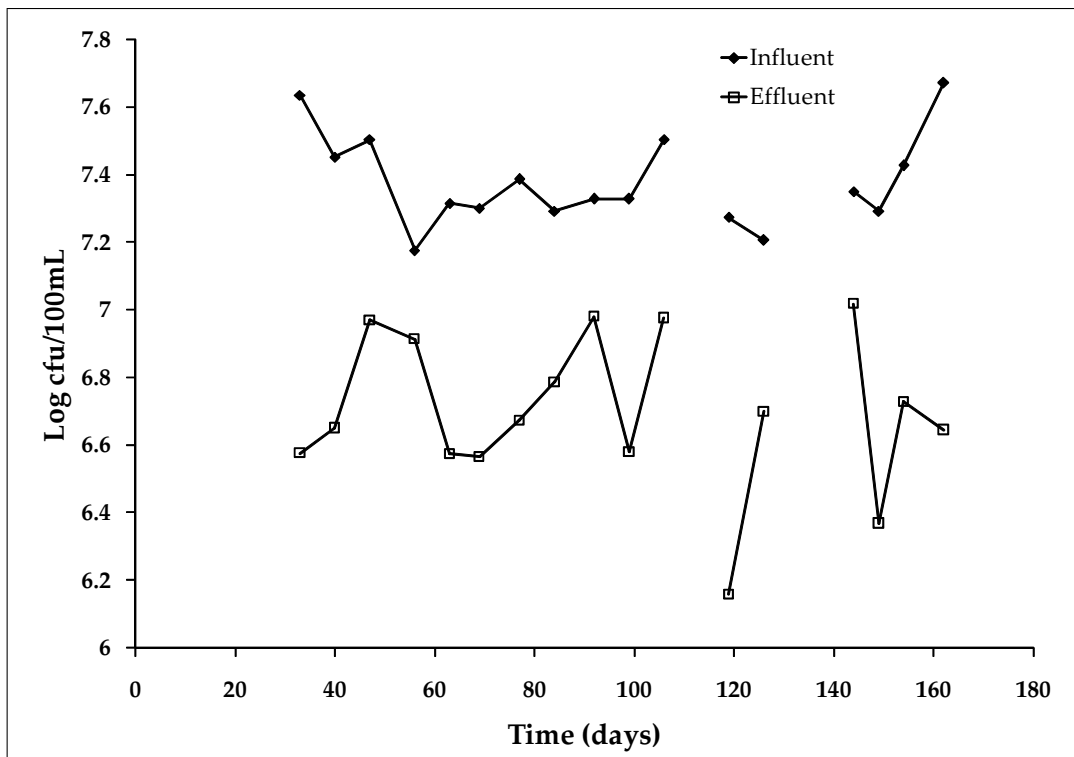

**Figure 4.7:** Graph showing the concentration of *E.coli* in the ABR influent and effluent.

The coliform samples yielded an average range of  $2 \times 10^7 - 1 \times 10^8$  cfu/100 ml in the influent and an average range of  $1 \times 10^6 - 2 \times 10^7$  cfu/100 ml in the effluent. The average removal of 86% of coliforms was significant (students t-test,  $p=0.000$ ). Figure 4.8 shows the total coliform counts for the influent and effluent samples.



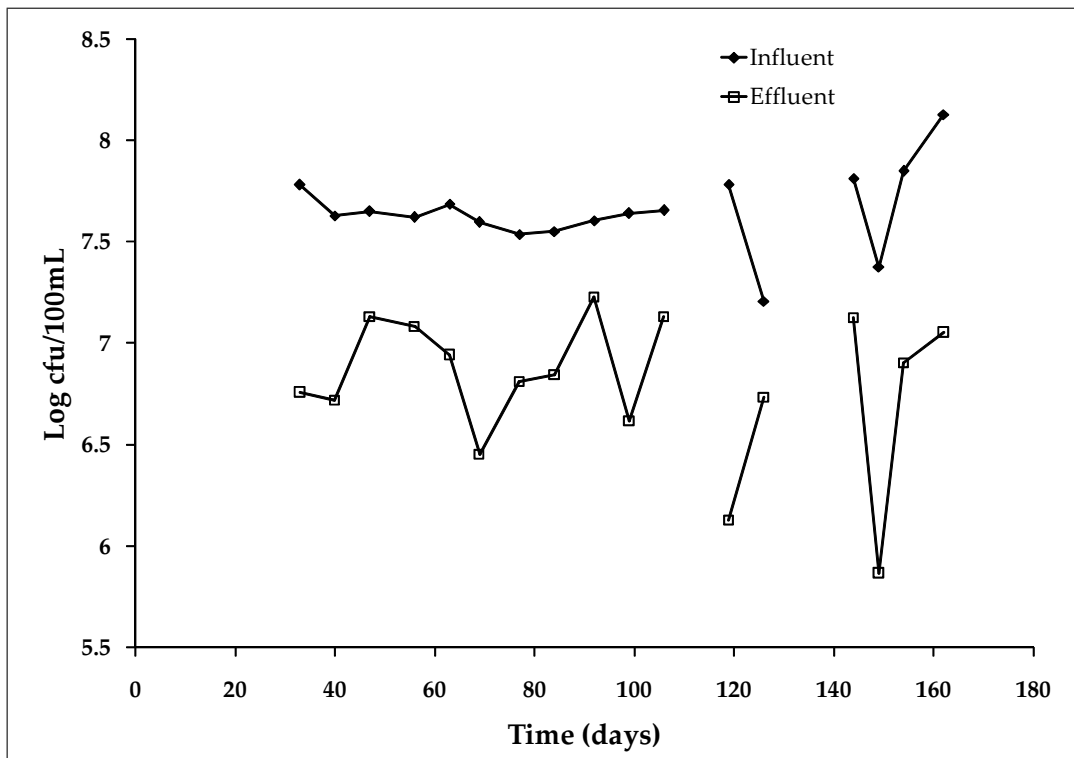

**Figure 4.8:** Graph showing the concentration of Faecal coliforms in the ABR influent and effluent.

#### 4.4 Summary of Results

Table 4.2 gives a summary of the results, and includes the parameter analysed, the average results for the influent and effluent, and the percent removal or reduction.

When compared with the DWA Water Quality Guidelines for Agricultural Water Use, the Total Suspended Solids were almost five times the guideline of 50 mg/l, the total coliforms were  $10^7$  times the limit for faecal coliforms and the pH was slightly below the limit. There are no guideline limits for COD or organic nutrients.

**Table 4.2:** Summary of the results for the operation of the ABR for a period of 162 days.

Parameter	Influent	Effluent	% Removal
Total COD	360 mg/l – 930 mg/l	62 mg/l – 160 mg/l	78% – 90%
Soluble COD	68 mg/l – 290 mg/l	18 mg/l – 150 mg/l	40% – 80%
Total Solids	500 mg/l – 1 076 mg/l	240 mg/l – 556 mg/l	40% – 70%
pH	7.2	6.5	-
Alkalinity	256 mgCaCO <sub>3</sub> /l	246 mgCaCO <sub>3</sub> /l	-
TKN	44.6 mgN/l	37.1 mgN/l	-
Phosphates	3.2 mgP/l – 32.5 mgP/l	10.3 mgP/l – 26.2 mgP/l	-
<i>E. coli</i>	1x10 <sup>7</sup> – 5x10 <sup>7</sup> cfu/100 ml	7x10 <sup>5</sup> – 1x10 <sup>7</sup> cfu/100 ml	76%
Total Coliforms	2x10 <sup>7</sup> – 1x10 <sup>8</sup> cfu/100 ml	1x10 <sup>6</sup> – 2x10 <sup>7</sup> cfu/100 ml	86%

---

---

## CHAPTER 5

---

# DISCUSSION

### 5.1 Startup

Prior to the initiation of this study, the pilot ABR was operated by the author in 2003 and part of 2004 at the Kingsburgh Wastewater Treatment Plant, for two different operating periods with two different hydraulic retention times (20 hours and 22 hours respectively). COD levels during this time appeared to be consistent and it was assumed that the microbial populations within the activated sludge were sufficiently developed for consistent removal (digestion) of Organic compounds (measured by COD concentrations) and solids.

Therefore, a sampling period to determine the operational performance of the ABR, at a hydraulic retention time of 42 hours, commenced and continued for 165 days.

### 5.2 Flow and Incidents

During the study period, there were no extended periods of downtime. There were a few operational issues at startup, which included variable flow rates and adjustments to the PLC to control flow rates at 1.6 l/min and achieve the desired retention time of 40 hours.

As a result there are gaps in some of the data during the start-up phase, and all parame-

ters other than COD, Solids and pH were only sampled after a period of normal operation (ie. no incidents) to ensure more accurate results. This accounts for the relatively few number of samples of Alkalinity, Total Kjeldahl Nitrogen and Phosphate.

## 5.3 Chemical Component

### 5.3.1 Chemical Oxygen Demand

The effluent values for COD showed a similar trend to influent values; where there was an increase in COD in the influent, there was a corresponding increase in effluent COD. However, effluent variations were small relative to the variations in the influent, and the ABR consistently achieved high removal rates of COD.

The effluent COD values obtained for this study were significantly lower than in the previous study with the same pilot reactor at Kingsburgh Wastewater Treatment Plant. This is due to the increase in hydraulic residence time (from 22 hours in the previous operating period to 42 hours for this study) (Foxon et al., 2005), which increased contact time with the anaerobic sludge beds of the ABR.

There were a sufficient number of COD samples (weekly, sometimes bi-weekly if there were any stops in the flow) to show a consistent reduction in COD values of between 78% and 90%.

There was a notable correlation between the influent and effluent results; the effluent COD values varied according to the influent concentrations, where there was an increased COD in the influent, there was a corresponding increase in the effluent. It was further noted that when there was an increase in COD in both the influent and effluent, there was a corresponding increase in the total solids concentrations.

Major operational incidences had little impact on the COD results obtained. On Day 20 no samples were taken as the initial start-up issues were still being resolved. On Days 72-85 all COD values were as expected and removal efficiencies remained above 80%. On Day 120 no samples were taken due to the period of ABR downtime. On Day 130 and

146, COD values were not apparently affected by the stoppage, and removal efficiencies remained above 80%.

### 5.3.2 Total Solids

Solids were consistently low in the effluent, showing a removal efficiency of 40% – 70%. The flow of water through each compartment would have an effect on retention of solids. The extended hydraulic retention time is most likely responsible for the high removal rates obtained during the study period. The overall WRC study (Foxon et al., 2005) found that solids retention within the internal compartments is the major factor which contributes to the performance of the treatment of wastewater by the ABR.

Any major increase in flow may have resulted in increased solids in the effluent, however no substantial increases in flow to the ABR occurred during the study period. Major operational incidences had no apparent impact on the solids results obtained. On Day 20 no samples were taken as the initial start-up issues were still being resolved. On Day 72-85 there were no unusual solids results and removal efficiencies remained between 40% and 70%. On Day 120 no samples were taken due to the period of ABR downtime. On Day 130 and 146, solids values were not apparently affected by the stoppage, and removal rates remained between 40% and 70%.

During routine maintenance of the ABR, it was noted that compartments were filling up with sludge, and when full, spilling over and filling the next compartment. During the study period, this occurred in compartments 5 and 6, but the study was concluded before solids were spilled over to compartment 7.

It is anticipated that this would have continued until solids were expelled from compartment 8 into the effluent and it is anticipated that very high solids would have been noted in the effluent. This implies that after a certain time, the ABR would require desludging, however the study did not continue for long enough to determine if and when this would be necessary. The ABR was designed with taps at the bottom of each compartment for the removal of predetermined volumes of sludge. Further studies would be required to determine the optimum volumes of sludge to be removed from each com-

partment.

### 5.3.3 pH and Alkalinity

Speece (1996) states that the optimal pH for anaerobic digestion ranges between 6.5 and 8.2. The influent pH values measured on site fell within this range. The pH values were not recorded regularly enough to make any correlation with other data.

Speece (1996) recommends that alkalinity concentrations of anaerobic treatment systems are sufficiently high to provide a "reserve alkalinity" that may neutralise additional acids produced during fermentation. This reserve alkalinity buffers the operating pH, such that the pH remains above 6.2, to prevent inhibition of microbes below pH range of 6.2–6.5.

To maintain pH at levels which sustain methanogenic activity, the system would have to have a suitable buffering capacity. This allows for the process to remain stable when the wastewater is characterised by high organic loading. Alkalinity of the system is determined by the alkalinity of the influent, which is dependant on local water hardness (and therefore local geological conditions) and the local treatment processes applied to the water supply to the residential areas. There are several alternatives available to adjust the alkalinity of the influent to allow for adequate buffering of the anaerobic processes.

The alkalinity results for this study were low when compared to typical anaerobic treatment systems, suggesting that the ABR was poorly buffered. The low alkalinity and poor buffering, however, did not appear to have an effect on COD or solids removal during this operating period of the ABR. It is unknown if the alkalinity would have had an adverse effect had the study continued for a longer period of time.

### 5.3.4 Total Kjeldahl Nitrogen

The reduction in TKN in the effluent may be due to the uptake or removal of Nitrogen by the microorganisms in the active sludge layer. The small number of samples (n=8) towards the end of the sampling period are not sufficient to indicate any particular trend

in the Nitrogen concentration.

The DWA Water Quality Guidelines for Agricultural Use do not provide a limit for Organic Nitrogen, as it is an important nutrient which is utilised by crops and other vegetation, thereby removing it from runoff which which may enter a water body. The concentration of TKN in the effluent is too high for direct discharge to a water resource, as Eutrophication would result from a buildup of nutrients in a water body.

### 5.3.5 Phosphate

Although there appears to be a slight decrease in Phosphate in the effluent, as compared to the influent, this was not found to be a significant difference (students t-test,  $P=0.005$ ). Further, normal anaerobic digestion has no mechanism to remove Phosphates or Phosphorous and as a result, this apparent decrease is attributed to the small number of samples ( $n=7$ ).

The DWA Water Quality Guidelines for Agricultural Use do not provide a limit for Phosphate, as it is an important nutrient which is utilised by crops and other vegetation, thereby removing it from runoff which which may enter a water body. The concentration of Phosphate in the effluent is too high for direct discharge to a water resource, as Eutrophication would result from a buildup of nutrients in a water body.

## 5.4 Microbial Component

Faecal coliforms were sampled and analysed as indicators of the presence of other pathogenic microbes, such as *Salmonella spp.*, *Shigella spp.*, *Vibrio cholerae*, *Campylobacter jejuni*, *Campylobacter coli*, *Yersinia enterocolitica* and pathogenic *E. coli* (Department of Water Affairs, 1996).

Although a significant reduction of *E. coli* and coliforms was found, the concentration of faecal coliforms found in the effluent was still substantially higher than the DWA guideline for irrigation (which is 1cfu/100ml, or approximately 10 000 *E. coli* cells). It is

probable that there were a range of pathogens contained in the wastewater which would show similar insufficient removal rates to the indicator organisms.

The concentrations of faecal coliforms found in the effluent may have significant risks to human health, and as they exceed the DWA guideline limit, are not suitable for discharge to the environment.



---

---

## CHAPTER 6

---

# CONCLUSIONS

### **6.1 Operation of the pilot Anaerobic Baffled Reactor at the Kingsburgh Wastewater Treatment Plant**

#### **Operation and Flow**

The pilot ABR operated smoothly with few incidents during the six month operating period. All incidents were a result of issues with the feed system and supporting equipment used to divert the required flow from the main sewer channel, including pump blockages and tripping of the pump, and limitations of the PLC algorithm. In a community or other situation, it is intended that the ABR would be gravity fed and treat the entire volume of wastewater generated and as a result, a power supply, pump and supporting equipment would be unnecessary. It is therefore concluded that the ABR would operate without incident, provided there was routine maintenance to prevent potential build-up of other materials and consumables that may accumulate in the wastewater, such as hair braids encountered during this study.

#### **Chemical Analyses**

The pilot ABR showed significant removal of COD and solids during the entire study period; between 70% and 90% COD removal and between 40% and 70% solids removal.

No nutrient removal should occur in an anaerobic treatment system. The increase in Ammonia concentrations is attributed to the liberation of organically-bound Nitrogen during digestion of organic material. The increased alkalinity of the effluent may be caused by the production of Bicarbonate and Carbonate during digestion (Foxon et al., 2005).

Significant concentrations of nutrients were still present in the effluent, and as a result, in terms of the DWA water quality guidelines (Department of Water Affairs, 1996), ABR effluent is unsuitable for discharge to surface or groundwater. However, since there are no guideline limits for organic nutrients for the use of water for agricultural uses, it is possible that the effluent may be used for irrigation purposes. The high levels of nutrients within the effluent would provide nutrients and promote healthy growth of agricultural crops.

### **Microbial Analyses**

The ABR achieved significant removal of microbial indicator organisms included in this study. However, the concentrations of these indicator organisms remained high in the effluent. Compared to the DWA guidelines for discharge to natural water resources, and for irrigation and domestic uses, these exceeded the guideline concentrations and are considered a risk to human health. It is therefore concluded that the effluent may not be used without further treatment.

### **The ABR as a Treatment Alternative**

Overall, the ABR proved to be a sturdy treatment system with many biological and hydraulic advantages over the conventional treatment systems (Foxon et al., 2005). Further the ABR would have lower installation, operation and maintenance costs in comparison with conventional treatment systems, and it provides a viable alternative for communities with dry sanitation that aspire to waterborne sanitation (Foxon et al., 2005).

However, the ABR was not found to treat wastewater to suitable chemical and microbiological standards as a stand alone treatment alternative for any end use, including irriga-

tion. For the ABR to become a possible treatment alternative, suitable post-treatment and appropriate use and/or discharge practise would have to be investigated. The ABR has no means for prevention of the build-up or for removal of solids, and an ABR treatment system would therefore require a pre-treatment step or maintenance plan for screening and removal of grit and other undesirable material.

---

---

## CHAPTER 7

---

# RECOMMENDATIONS

Although the ABR is a feasible treatment alternative in terms of its design and overcoming the challenges of the requirements of the local communities, this study found that:

- The effluent is not suitable for any other use without further treatment.
- ABR effluent is unsuitable for discharge to surface or groundwater.

This study was concerned solely with the operational performance of the pilot ABR used to treat wastewater from a peri-urban community. The results obtained are based on relatively stable operating conditions, with a continual flow and consistent flow rate, and constant skilled management of the system. In a community situation, the flow of wastewater would be variable, the organic and nutrient loading would be highly variable and there may be inconsistent management or mismanagement of the ABR. Further research is required to determine the performance of the ABR in a "real-life" community situation.

Since the ABR is not considered a stand alone treatment alternative, further research is required to determine the role of the technology in an integrated wastewater treatment system. It is most likely that the ABR would be a suitable pre-treatment alternative, however this should be fully investigated in a community location. The ABR is considered a more effective treatment of wastewater than the septic tank, it is recommended that the use of the ABR is investigated in cases where the septic tank is a feasible option.

---

---

## APPENDIX A

---

# MEMBRANE STUDY

### A.1 Introduction

This membrane study was conducted as a separate side interest study to determine whether any post-treatment alternatives might be feasible for future investigation. This study was not officially part of the WRC research project, but the data was collected by the author as part of the side interest study. The results indicated that bio-membrane filtration was successful in the removal of solids and pathogens, which is why it has been included in the Appendix.

A submersible Kubota A4 membrane cartridge was donated to the project by AQUATOR for preliminary investigations. The cartridge consisted of flat membrane sheets sealed to both sides of the membrane panel through ultra-sonic welding. The membrane cartridge had an area of 0.106 m<sup>2</sup> and a pore size of 0.4 µm.

The membrane cartridge operates by being submersed in the wastewater, water flows through the micro structure of the membrane sheets, and the treated water flows out of the cartridge through a nozzle at the top, as shown in Figure A.1

The Kubota A4 membrane has been proven to remove COD, total solids and high concentrations of suspended solids. It has also been shown to remove nutrients from wastewater. The membrane cartridge system is relevant to this project as it is specifically designed for treatment of wastewater and does not require any energy inputs for operation. It would therefore be suitable for a community operated ABR.

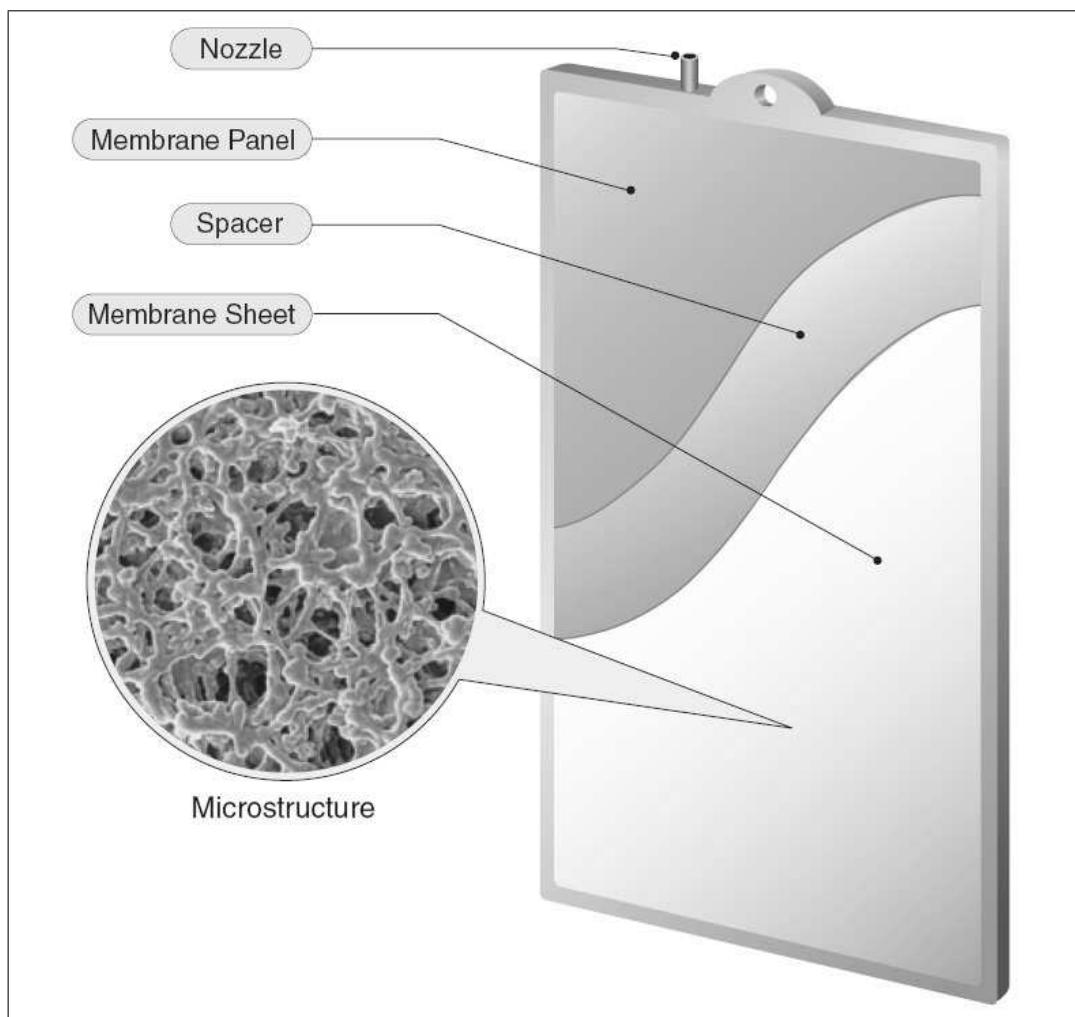

**Figure A.1:** The Kubota A4 membrane cartridge (Kubota Corporation, n.d.).

## A.2 Materials and Methods

### A.2.1 Membrane and Unit

A separate unit was constructed to house the membrane for the duration of the membrane study. This unit was designed at 1/26<sup>th</sup> the scale of the eighth compartment of the ABR, and connected to the ABR via the sampling port, thereby acting as a smaller reproduction of this compartment. The membrane was suspended in the upper part of the unit and a lid was made to fit.

Clean water tests were performed in the laboratory before the membrane and unit were set up with the ABR. A hose was suspended above the unit and tap water continually fed into the unit, in order to keep a constant water level. Water was drawn through the membrane using a small tube as a siphon. This tube emptied into a funnel, which lead to a 25 l collection vessel. These tests were used to establish flux (in l/m<sup>2</sup>hr) at different head heights, and to determine the optimal head to be used during operation at the wastewater treatment plant.

Thereafter, the membrane and unit were transported to the Kingsburgh Wastewater Treatment Works and connected to the eighth compartment of the ABR. Figure A.2(a) and Figure A.2(b) shows the membrane unit installed at the Kingsburgh Wastewater Treatment Plant. The unit was filled with effluent from the ABR and the taps between the unit and ABR were opened to allow the sludge to slowly fill the unit to a level equal to that of the compartment. Flow through the membrane was started the following day, to allow all solid matter to settle overnight.

Initial tests were performed to determine an appropriate method of cleaning the membrane. These tests included measuring the flux before and after rinsing the membrane, spraying with pressured tap water or backwashing. The membrane was later dried out and left standing over a two week period as the final part of the cleaning test.

As a result of excessive fouling of the membrane and time constraints imposed by traveling to the wastewater treatment works, the membrane and unit were later transported back to the laboratory for continuous tests. A 25 l vessel filled with ABR effluent was

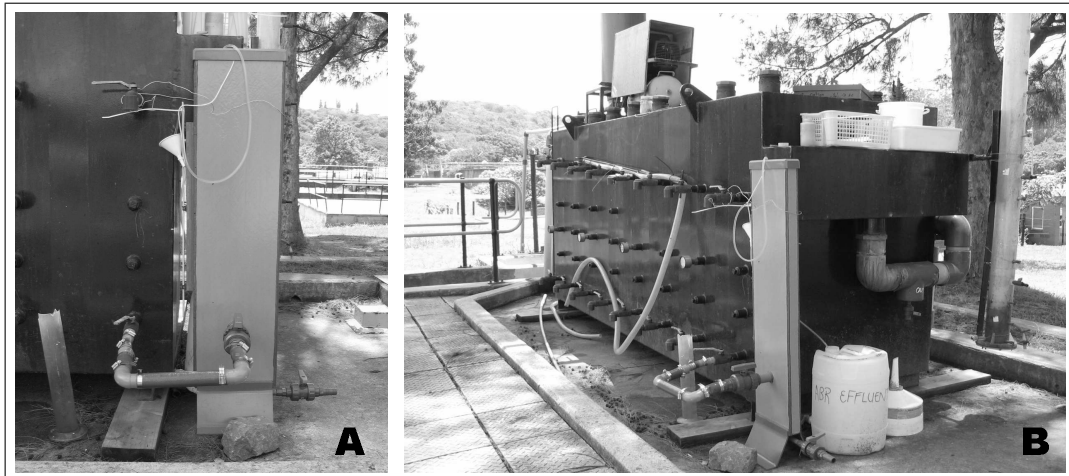

**Figure A.2:** (a) shows a side view of the membrane unit after it was installed and (b) shows the ABR, unit and the membrane effluent collection vessel.

positioned above the membrane unit, allowing effluent to continually flow into the unit, to keep a constant head height of 15 mm. The membrane filtrate was collected in sterile glass bottles. At first, these were performed for five hours per day over a period four days, and thereafter, 24 hours per day for five days, (without interruption) with ABR effluent. The membrane was cleaned between each run, with pressured tap water.

For the membrane study, grab samples were collected from the 25 l feed vessel and from the outlet pipe. Simultaneously, COD and total solids were analysed from the ABR effluent and membrane filtrate and *E.coli* and total coliforms analyses were also performed.

### A.2.2 Coliforms

Coliforms were measured using the membrane filtration technique (American Public Health Association, 1985). Enumerated coliforms included total coliforms and *E. coli*. Grab samples were serially diluted and filtered through a gridded 0.45  $\mu\text{m}$  membrane filter. Filters were aseptically placed on Chromocult Coliform Agar (Merck), and incubated at 35 °C for 18–24 hours. *E. coli* colonies and total coliforms were identified by colour (Sudhir Pillay, personal communication, 2005).

*(All microbial analyses were performed by Sudhir Pillay at the School of Life and Environmental Sciences at UKZN)*



### A.3 Results and Discussion

The area of the membrane was measured and calculated to be  $0.11054 \text{ m}^2$ , and this value was used for all flux calculations. The flux values were not corrected for temperature, although the temperature of the water or effluent in the unit was recorded for each test.

#### A.3.1 Preliminary Flux Tests

Figure A.3 shows the initial clean water flux measurements from the membrane, performed on two consecutive days, at varying head heights between 100 mm and 850 mm. The lower flux values from the tests of the second day show that slight fouling of the membrane had occurred.

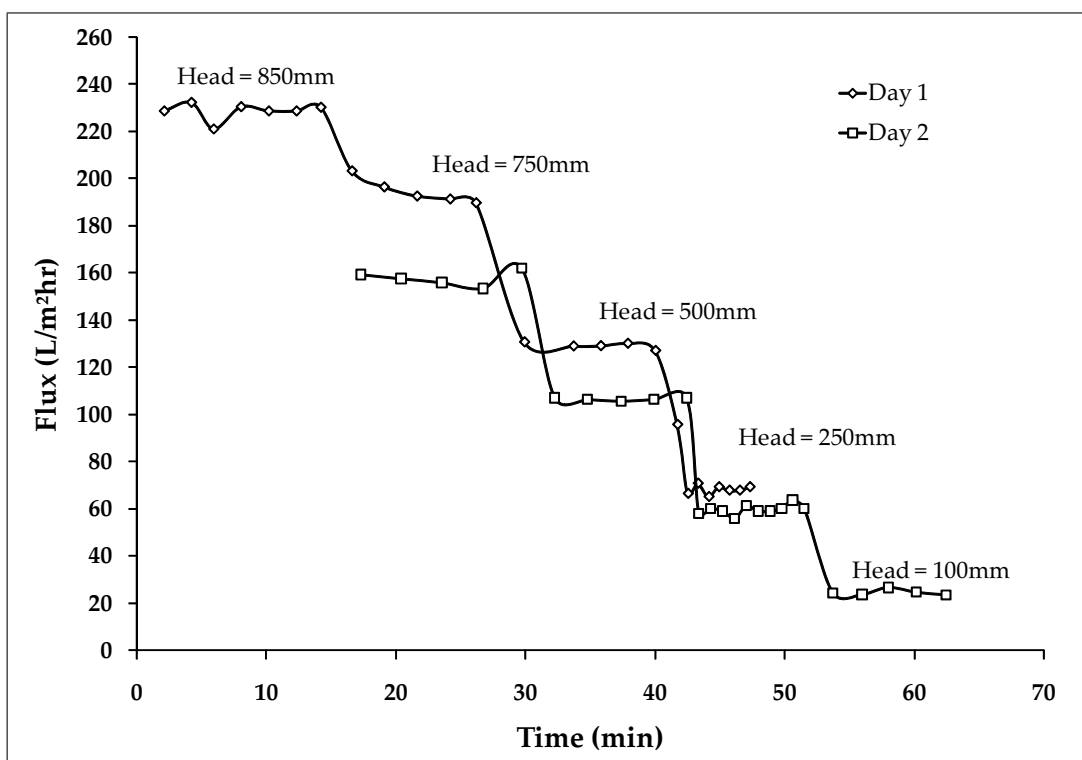

**Figure A.3:** Clean Water Flux tests performed in the laboratory using tap water.

A second run with clean water through the membrane (starting with a head of 750 mm, slowly reducing it to 100 mm and returning to 750 mm) showed the continuity of the flux at each head, shown in Figure A.4. The membrane and unit were then moved to the Kingsburgh Wastewater Treatment Works, where only ABR effluent was used, to

again determine flux at each head between 100 mm and 850 mm, shown in Figure A.5. This graph shows that the flux decreased substantially over a short time at each head, indicating a high degree of fouling due to the solid content of the ABR effluent. This is also the reason for the lower flux values at the 850 mm head - the clean water flux values were higher for the 850 mm than the 750 mm head as shown in Figure A.3.

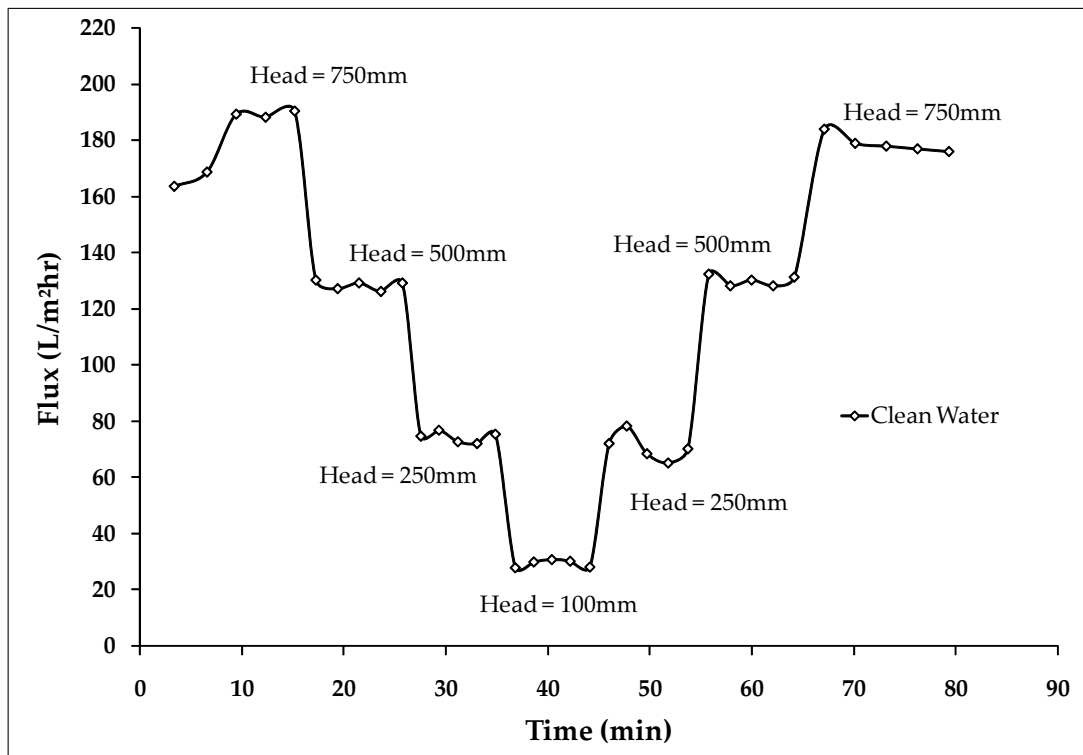

**Figure A.4:** Clean water flux at each head from 100 mm to 750 mm.

In figure A.6, the head height from each data set was plotted against the flux, resulting in a straight line for each set. This was performed to confirm the quality of the data obtained in the flux tests.

From these preliminary clean water and ABR effluent tests, it was determined that the optimal head height was 100 mm, in the hope that the membrane would yield a flux of approximately 4 l/m²hr.

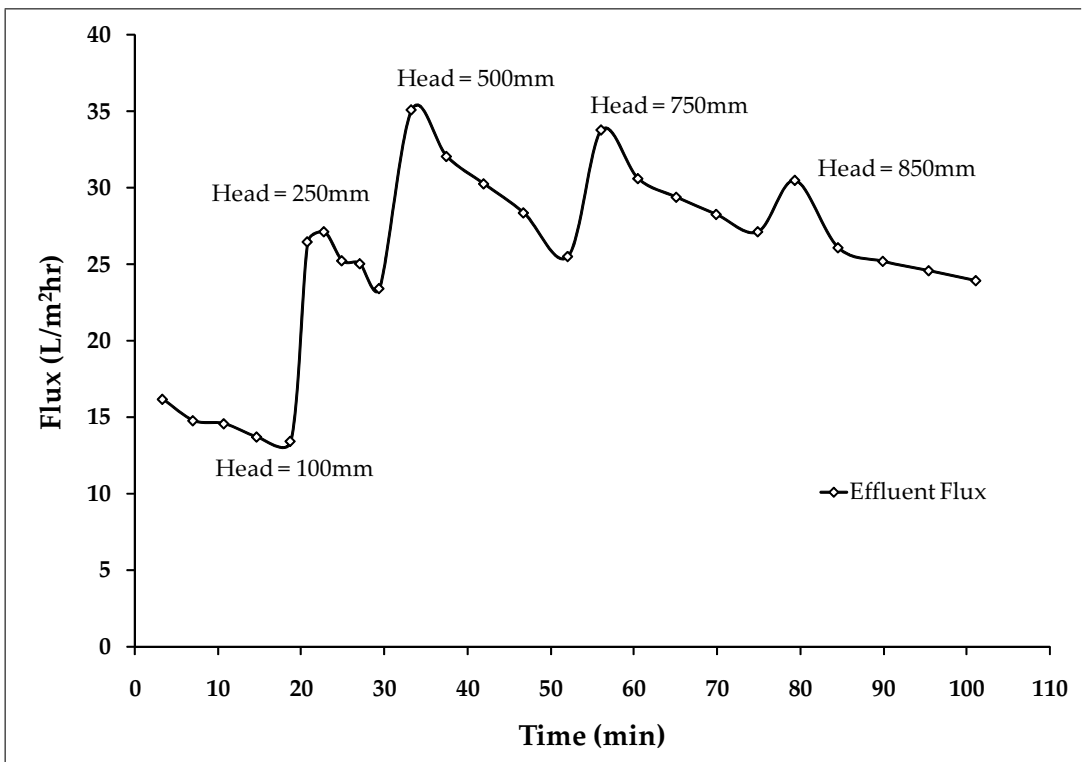

Figure A.5: Effluent flux at each head from 100 mm to 850 mm.

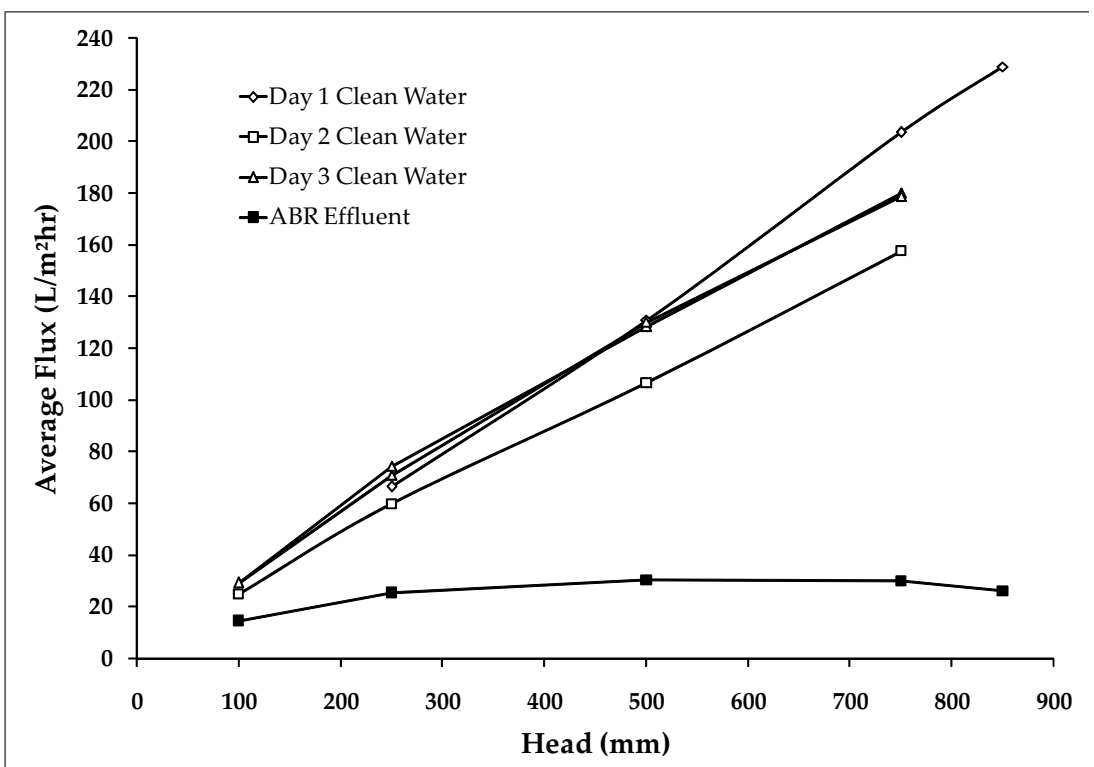

Figure A.6: Average flux from each run vs. head height.

### A.3.2 Cleaning Tests at Kingsburgh Wastewater Treatment Plant

Once the membrane and unit had been connected to the ABR, and the solids were allowed to settle, flow through the membrane was started, and allowed to continue overnight. The flux fell from  $14.56 \text{ l/m}^2\text{hr}$  at startup, to  $4.16 \text{ l/m}^2\text{hr}$  the following day, due to fouling of the membrane. The membrane was then cleaned, first by a simple rinsing under gently running water, then by backwashing clean tap water through the membrane and finally by vigorously spraying it with pressured clean tap water using a hose. Flow was restarted and flux measurements taken between each step. Figure A.7 shows the resulting flux after each cleaning method. The final data set shows the rapid decrease in flux measurements, again indicating a high degree of fouling of the membrane.

The membrane was later dried out prior to further laboratory tests, and the flux returned to the initial high values of the preliminary tests. Furthermore, it was found that at 100 mm head height, the flow was extremely sensitive and sometimes fluctuated. When taking measurements, air bubbles sometimes entered the outflow tube, either reducing or stopping the flow. As a result the head height was adjusted to 150 mm.

### A.3.3 Laboratory Flux Tests

Due to the time required for continuous tests and the rapid fouling of the membrane, the membrane and unit were returned to the laboratory. COD, solids (both total solids and total suspended solids), total coliforms and *E.coli* were measured at the start, mid-point and end of each run. Figure A.8 shows the first clean water test and the two subsequent 5 hour effluent runs. The first clean water test was resumed after the membrane had been dried and left standing for two weeks, and an initial flux of  $40.11 \text{ l/m}^2\text{hr}$  was obtained, which decreased to  $13.49 \text{ l/m}^2\text{hr}$  over the 5 hour run. Thereafter, the run was twice repeated with ABR effluent, without cleaning the membrane between runs. The flux dropped to  $3.14 \text{ l/m}^2\text{hr}$  and remained almost constant for the duration of the second effluent run.

The membrane was then rinsed and dried out overnight, however the second clean wa-

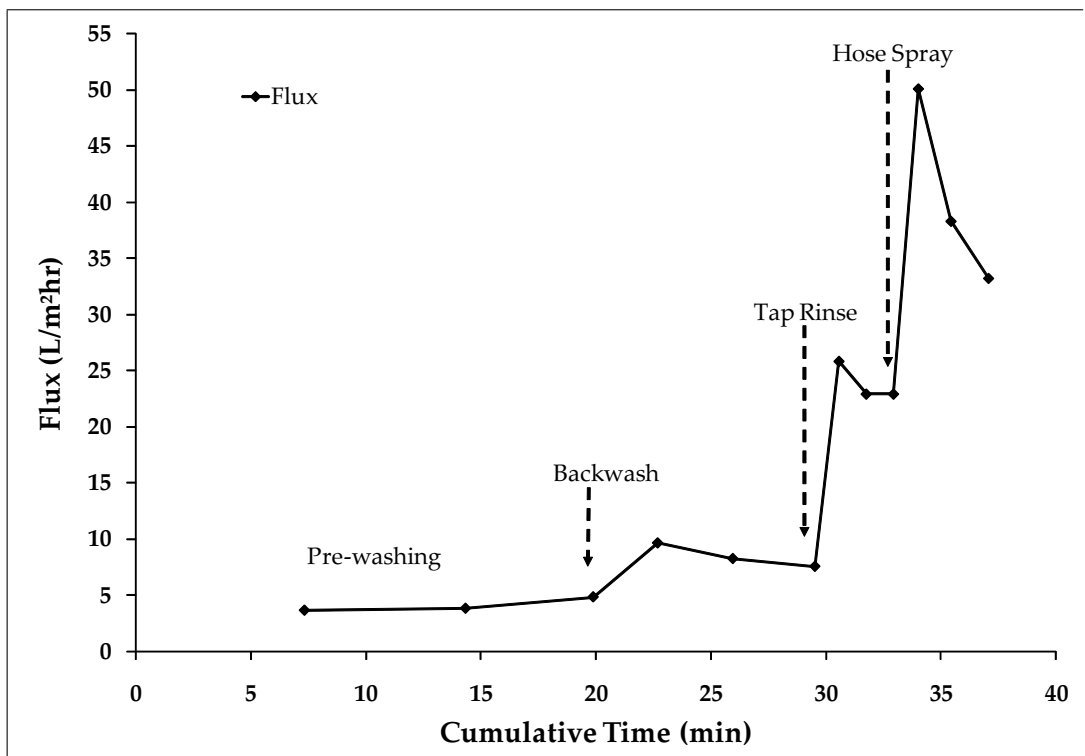

Figure A.7: Flux prior to cleaning and after backwashing, tap-rinsing and pressured spray.

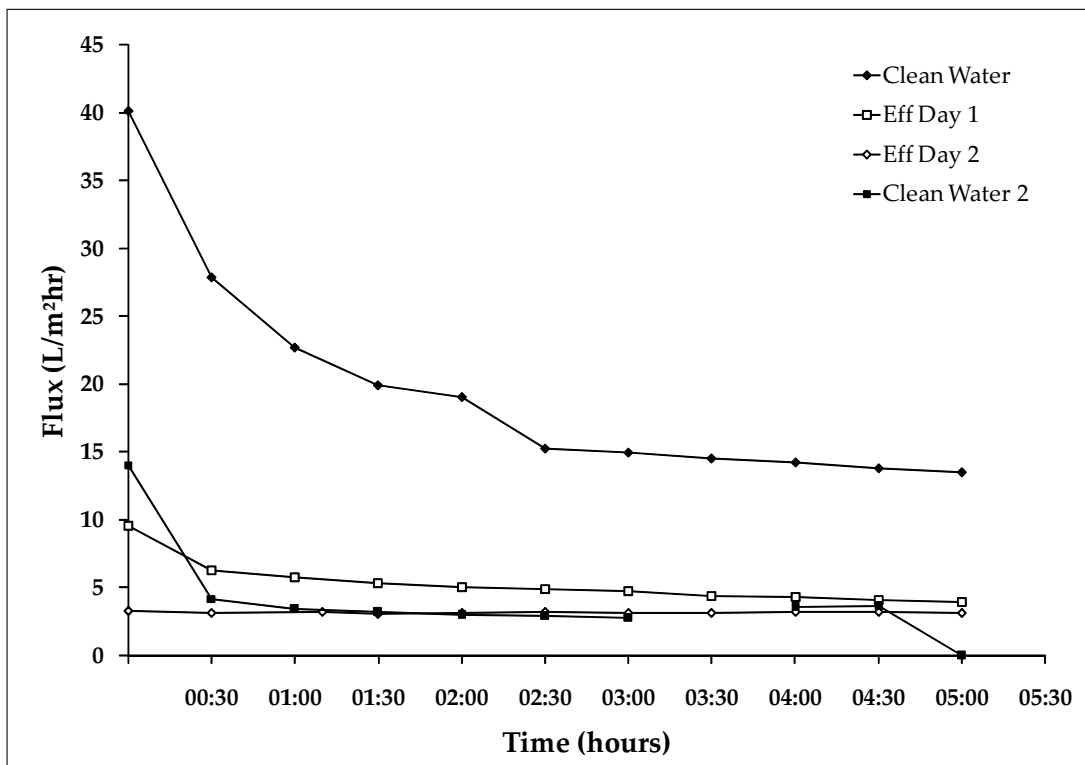
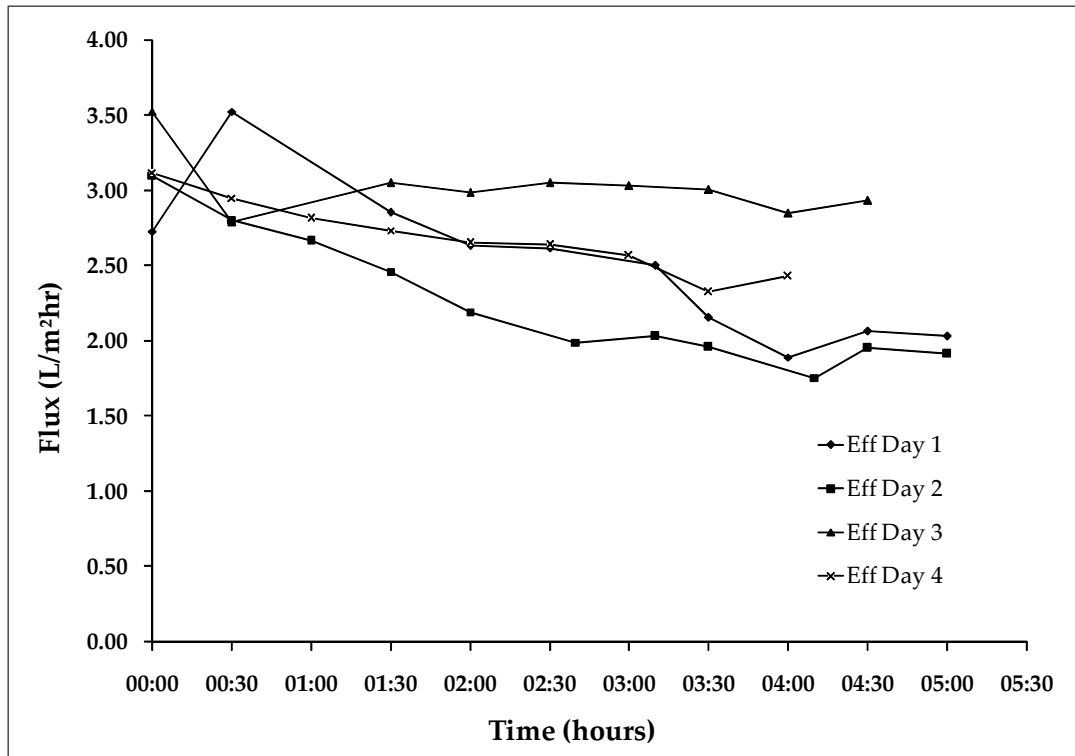

Figure A.8: Graph showing the flux from two clean water runs and the two 5 hour effluent runs on the membrane.

ter run showed low flux measurements (see Figure A.8, that never returned to their previous high values. Following this, 5 hour runs over 4 days were performed, without cleaning the membrane between runs. Figure A.9 shows that the flux decreased slowly each day, but increased again upon restarting.



**Figure A.9:** Graph showing the flux from the 4 day test (of 5 hours per day) on the membrane.

Thereafter, the membrane was only cleaned with pressured tap water and flow was restarted for the continuous 5 day run. Figure A.10 shows the flux decreasing from 3.13 l/m²hr at the start of the run, to 1.42 l/m²hr after 54 hours. During the third and fourth nights of the continuous run, the flow of effluent to the membrane unit stopped, resulting in a reduced pressure head and causing the flow through the membrane to stop (indicated by the vertical lines a and b in Figure A.10). This would account for the varied flux upon restarting the flow. During each of the tests, the membrane never became clogged or fouled enough to stop the flow.

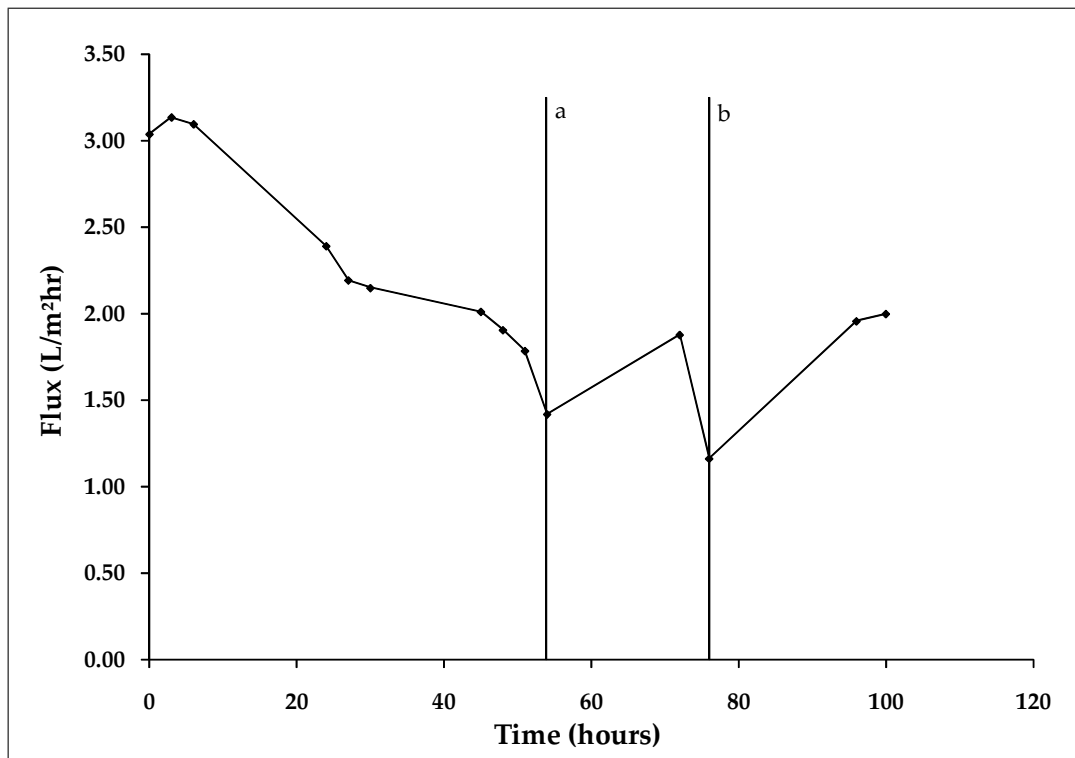

**Figure A.10:** Graph showing flux over time, for 5 consecutive days. The lines a and b indicate the times when the water level in the unit dropped, reducing the head and stopping flow.

### Chemical Oxygen Demand and Total Solids

Figure A.11 shows the efficiency of solids removal by the membrane, whilst operating the Kingsburgh Wastewater Treatment Plant. The first bottle is a sample of ABR influent, which was found to have an average COD of 1380 mgO<sub>2</sub>/l and 637.33 mg/l total solids. The second bottle contains ABR effluent which was found to have an average COD of 120 mgO<sub>2</sub>/l and 180 mg/l total solids. The third bottle is a sample of membrane filtrate, which was found to have an average COD of 110 mgO<sub>2</sub>/l and 32.2 mg/l total solids, which is almost 60% removal of solid material. Note the clarity of the water in the third bottle, once it has passed through the membrane.

Total solids and total suspended solids were measured from the effluent at the start of each run and from the membrane filtrate each day during the laboratory tests. Total solids were measured in 1.5 l of membrane filtrate, and total suspended solids were measured from the total collected volume from each day, both gave a result of 0 mg/l, demonstrating that the membrane caused total solid removal.



**Figure A.11:** Three sample bottles, from left to right - ABR influent, ABR effluent and membrane filtrate.

COD samples were taken at the same time as the total coliform and *E.coli* samples, at the start, mid point and end of each run on each day. Table A.1 shows that the membrane had no significant effect on COD.

ABR Eff	t=0	t=2.5	t=5
321.89	328.27	334.19	317.02

**Table A.1:** COD results from ABR effluent and membrane filtrate

## Pathogens

Figure A.12 and Figure A.13 show that total coliform and *E.coli* plate counts from ABR effluent and the membrane filtrate showed that the membrane caused a 5-log removal of these pathogens from the wastewater. The vertical lines show when fresh effluent was collected and introduced into the membrane unit, this would account for the increased numbers of colony forming units (cfu) for the fourth set of data.

It is interesting to note that as the flux decreased with time so also did the coliform and *E.coli* counts. This is most likely due to natural mortality rates of the microorganisms over a period of a few days.



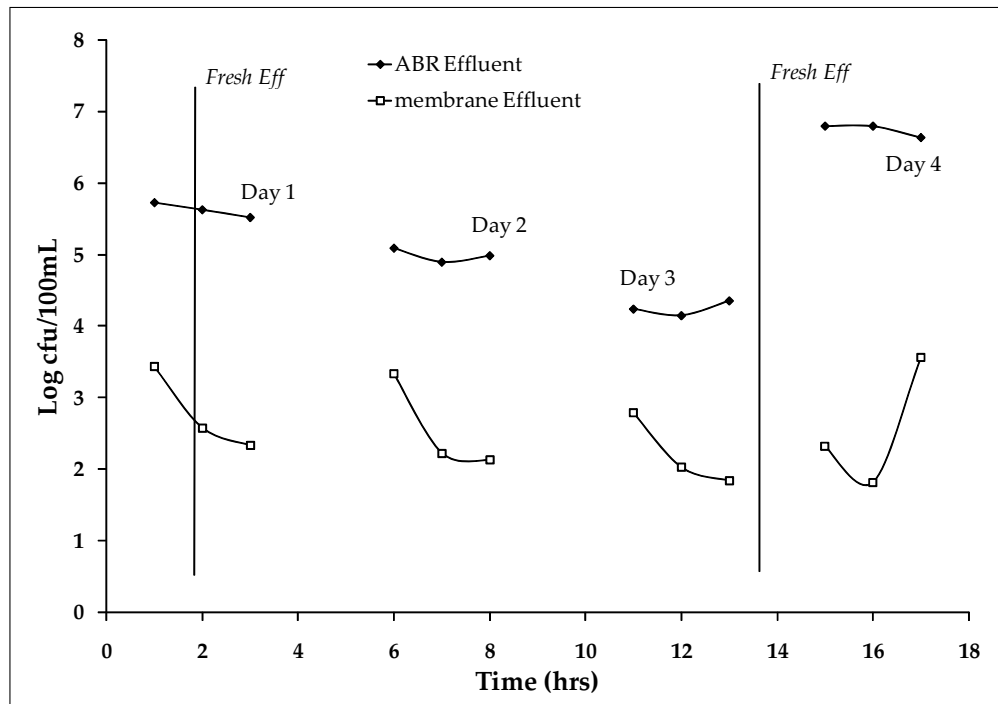

**Figure A.12:** Membrane removal of *E. coli*; showing the log values of colony-forming units pre- and post- filtering through the membrane. The vertical lines show when fresh ABR effluent was collected.

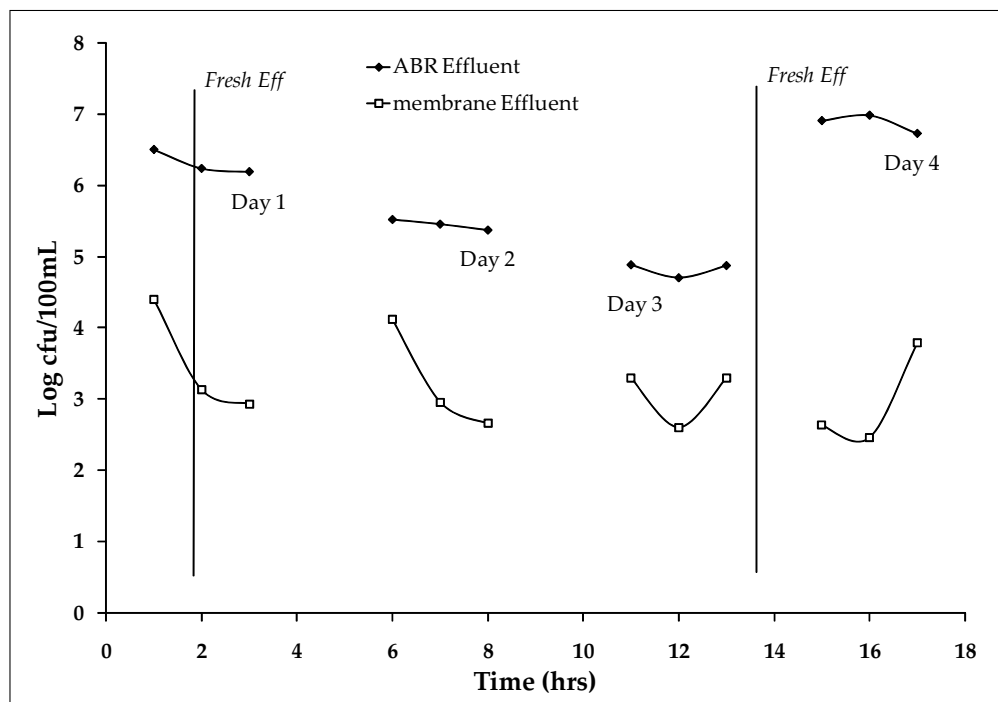

**Figure A.13:** Membrane removal of coliforms; showing the log values of colony-forming units pre- and post- filtering through the membrane. The vertical lines show when fresh ABR effluent was collected.

It was expected that the membrane would show greater capacity to remove pathogens. However, after these tests were completed, a pin-prick sized hole was discovered in the membrane, and it is unclear when this damage may have occurred. This may account for lower pathogen removal rate. As a result the membrane was planned for repair and a small pump purchased in order to repeat the all the tests without interruptions. The membrane was again dried out, but it was found that flow through the membrane could no longer be induced. It was then soaked in a 10% bleach solution, and backwashed with the same solution, however, the solution would not flow back through the membrane. Thereafter the membrane was rinsed in distilled water and soaked in the bleach solution for a further two days, but flow could still not be induced. As a result the tests were shelved for a later time.

#### **A.4 Conclusion**

The small side interest study indicated that the membrane technology is highly effective in the removal of indicator pathogens. However, it is an expensive technology and treatment of wastewater with such a membrane is slow and inefficient for large volumes. This side study therefore suggested that this membrane is not a suitable post-treatment option for ABR effluent, but that there is a potential for post-treatment alternatives which may allow the ABR to become a suitable sanitation alternative.

There is much research into the use of biomembranes at present, specifically into the integration of biomembranes with the ABR. The Pollution Research Group continued with Membrane Bioreactor and ABR (MBR/ABR) research after the completion of the WRC ABR project.

---

# REFERENCES

- American Public Health Association (1985), *Standard Methods for the Examination of Water and Wastewater*, 16 edn, APHA, AWWA, WPCF.
- Bailey, J. and Ollis, D. F. (1986), *Biochemical Engineering Fundamentals*, 2nd edn, McGraw-Hill International Editions.
- Barber, W. and Stuckey, D. (1997), 'Start-up strategies for anaerobic baffled reactors treating a synthetic sucrose feed', *Proceedings of the 8th International Conference on Anaerobic Digestion*, Vol. 2, Sendai, Japan.
- Barber, W. and Stuckey, D. (1999), 'The Use of the Anaerobic Baffled Reactor (ABR) for Wastewater Treatment: A Review.', *Water Research* **33**(7), 1559–1578.
- Civil and Environmental Engineering, University of Witwatersrand (2003), 'Wastewater engineering course notes'.
- Dama, P., Bell, J., Foxon, K. M., Brouckaert, C. J., Huang, T., Buckley, C. A., Naidoo, V. and Stuckey, D. (2002), 'Pilot-Scale Study of an Anaerobic Baffled Reactor for the Treatment of Domestic Wastewater.', *Water Science and Technology* **46**(9), 263–270.
- Department of Water Affairs (1996), 'South African Water Quality Guidelines - Volume 4: Agricultural Water Use: Irrigation, 2nd Edition'.
- Department of Water Affairs (2002), 'The Development of a Sanitation Policy and Practice in South Africa.', *Preliminary Draft Paper, African Sanitation and Hygiene Conference, Johannesburg, South Africa, 29 July - 1 August 2002* .
- Department of Water Affairs (2003), 'Strategic Framework for Water Services ', (<http://www.dwaf.gov.za/Documents/Policies/StrategicFrameworkapproved.pdf>) .

- Department of Water Affairs (2009), 'Free basic sanitation implementation strategy', Policy Document.
- DWA National Sanitation Programme Unit (2008), 'Access to sanitation services and options for choice of technology', Presentation at municipal indaba by C. Mazubane.
- Foxon, K., Buckley, C., Dama, P., Mtembu, D., Rodda, N., Smith, M., Pillay, S., Arjun, N., Lalbahadur, T. and Bux, F. (2005), 'Evaluation of the Anaerobic Baffled Reactor for Sanitation in Dense Peri-urban Settlements', *Final Report to the Water Research Commission*.
- Foxon, K., Dama, P., Brouckaert, C. and Buckley, C. (2001), 'Design Considerations for the Implementation of an Anaerobic Baffled Reactor in Low-Income Settlements in KwaZulu-Natal.', *Proceedings of the IWA Conference on Water and Wastewater Management for Developing Countries, Kuala Lumpur, Malaysia, 27 October 2001*.
- Foxon, K., Mtembu, D., Pillay, S., Rodda, N., Smith, M. and Buckley, C. (2004), 'The Anaerobic Baffled Reactor (ABR): An Appropriate Technology for On-Site Sanitation.', *Proceedings of the 1st International Conference on Onsite Wastewater Treatment and Recycling, 11 to 13 February 2004, Esplanade Hotel Fremantle, Western Australia 2004*.
- Kubota Corporation (n.d.), 'Kubota submerged membrane unit', <http://www.kubota.co.jp/>.
- Langenhoff, A. and Stuckey, D. (2000), 'Treatment of dilute wastewater using an anaerobic baffled reactor: Effect of low temperature', *Water Research* **34**(15), 3867–3875.
- National Sanitation Policy* (2002), White Paper.
- Peng, J., Wang, H. and Ye, C. (2008), 'Experimental study on divisional influent of anaerobic baffled reactor', *Journal of Jilin Architectural and Civil Engineering Institute* **25**(4), 60–62.
- Pillay, S., Foxon, K., Rodda, N., Smith, M. and Buckley, C. (2005), 'The use of effluent from an anaerobic baffled reactor (abr) for agricultural use in peri-urban communities', Third International Conference on Ecological Sanitation.

- Sincero, A. and Sincero, G. (2003), *Physical-chemical treatment of water and wastewater*, CRC Press, co-publisher IWA Publishing, UK.
- Speece, R. (1996), *Anaerobic Biotechnology for Industrial Wastewaters*, Archae, Nashville, TN.
- StatsSA (2009), 'Household survey 2008', *Statistical release P0318* .  
<http://www.statssa.gov.za/publications/P0318/P0318July2008.pdf>.
- Weiland, P. and Rozzi, A. (1991), 'The start-up, operation and monitoring of high-rate anaerobic treatment systems: discussers report.', *Water Science Technology* 24(8), 257–277.
- Wikipedia (2009), 'Spss', <http://en.wikipedia.org/wiki/SPSS>.
- World Bank (2002), 'The National Water and Sanitation Programme in South Africa: Turning the 'Right to Water' into Reality'.