

**The development and use of an automated cellular PIT tag  
reader system for assessing the activity patterns of the  
Sungazer (*Smaug giganteus*)**

WADE STANTON-JONES  
601874



A dissertation submitted to the Faculty of Science, University of the  
Witwatersrand, Johannesburg, South Africa, in fulfilment of the requirements  
for the degree of Master of Science

Supervisor: Professor Graham Alexander

May 2018

## DECLARATION

---

I, Wade Stanton-Jones (Student Number: 601874), hereby declare the following:

- i. I have read and understood the document containing plagiarism guidelines for students in the School of Animal, Plant and Environmental Sciences, and acknowledge that plagiarism is unacceptable.
- ii. I confirm that the work contained herein is my own, unaided work except where I have explicitly indicated otherwise.
- iii. I have followed the required conventions in referencing the thoughts and ideas of others.
- iv. I understand that the University of the Witwatersrand may take disciplinary action against me if it is believed that this is not my own, unaided work or that I have failed to acknowledge the source of the ideas or words in my writing.

Signature:



Date: 28/05/2018

## **DEDICATION**

---

I dedicate the following work to my late mother, Lynne Stanton-Jones, who always drove me to succeed in my passions. I will forever be inspired by the example she set for me in her short life.

## ACKNOWLEDGEMENTS

---

Firstly, I would like to thank my supervisor, Professor Graham Alexander, for accepting me as a student in his lab and for the invaluable support, encouragement and guidance to get me through this study. I am also thankful for the valuable life lessons he taught me, especially how to manage my life in stressful situations. Additionally, I thank Graham for the financial support he provided for a reliable field work vehicle when my vehicle was unavailable.

I am indebted to Alex Bass from Bassix Audio. Alex played a major role in Chapter 2 of this study especially in the construction and initial testing of the automated system we developed for this study. My knowledge has certainly broadened from Alex's expertise on radio-frequency technology. He has taught me how to work through complex situations, which I will carry with me throughout my career and personal life.

I would like to thank Peter Wales for his hospitality and for allowing me free access to the guest house on his farm, Windheuwel Shooting Lodge, in which I spent many nights.

Importantly, I thank Peter for allowing me to conduct this study on the Sungazers on his farm and for allowing me to leave all my tracking equipment for the six months of data collection. I admire Peter's passion for Sungazers. Additionally, I would to thank Peter and his farm manager, Kat, for continuously checking up on my equipment and its standing in the field.

I would also like to thank all the people who assisted me in field work, especially to Hamish Warnes and Andrew Robson, who spent many days assisting me with tagging Sungazers and setting up the field equipment. To the members of the Alexander Herp Lab: many of them joined me in the field during regular checks and for that I am grateful. I am also thankful to the Alexander Herp Lab members for their assistance and support during the data analysis and writing stages of my study. A special mention to Shivan Parusnath for his guidance and knowledge on Sungazers. Shivan also assisted me in the application for the funding of this project by the Ruffords Small Grant Foundation.

I thank the University of the Witwatersrand for providing me with funding during the course of the MSc through the post-graduate merit award. I would also like to thank the Rufford Small Grant Foundation (Booster Grant – 18728-B) for financially supporting this study. Additionally, the financial assistance of the National Research Foundation (NRF) towards this research is hereby acknowledged. Opinion expressed and conclusions arrived at, are those of my own and are not necessarily to be attributed to the NRF.

A special thanks to all my friends who supported me, encouraged me and assisted me throughout the various stages of my project. A special mention to my family, and importantly to my father, Keith Stanton-Jones for his endless financial and emotional support, and belief in me. I will forever be grateful for the sacrifices he and my late mother, Lynne Stanton-Jones, made for me to accomplish my dreams.

Finally, and most importantly, I would like to thank my girlfriend, Nicole Cornelius, not only for her occasional assistance out in the field but especially for the endless support and encouragement she provided me with. I will forever be grateful for her in this regard and for putting up with me during the most stressful stages of my life.

This project was cleared by the University of the Witwatersrand's Animal Ethics and Screening Committee, ethics number: 2016/06/30/B. Permits for this study was received by the Free State DESTEA, permit numbers: 01/34741 and JM938/2017.

## ABSTRACT

---

The activities and movement patterns of animals have been of strong interest to researchers for decades. The technological growth over the last few decades has resulted in studies on animal activities presenting more accurate, reliable findings. As a result, very few studies still use the conventional, direct observation technique to monitor activity patterns. Additionally, there has been a growing interest in modern tracking equipment, especially the use of radio-frequency identification (RFID) technologies. Typically, RFID systems only comprise of two main components to monitor animal activities: the transponder tag which is fitted to an animal either externally or subdermally, and the interrogator (reader) which electromagnetically powers the transponder to read its unique identification code. The reader itself can be handheld or automated. However, the automated reader systems (ARS) are limited by storage capacity of the datalogger and still require a researcher to actively attend to the system to download the captured data. In light of this, the first aim of this study was to develop an automated cellular reader system (ACRS) that enables completely remote access to data at any given time, from any electronic device with internet connectivity. The second aim was to implement the newly designed system in an assessment of the activity patterns of Sungazers over two seasons, winter and spring. I followed the FDX-A protocol to develop an autonomous reader capable of reading 125 kHz passive integrated transponder tags (PITs), which were subdermally injected into 58 Sungazers (*Smaug giganteus*), a species known to be highly sedentary. I developed 12 ACRSs which were each fitted with a cellphone engine in which a SIM card was installed in each reader and loaded with data and airtime, monthly, for the 6-month duration of the study. The reading antennas were fitted around the circumferences of 12 Sungazer burrows and the activity patterns of the Sungazers were monitored. The ACRSs provided a 98.5% success rate in their ability to report on the emergence and retreating activities of Sungazers. The ACRSs recorded data from 10 Sungazers. Six Sungazers were active for 37.3% of the days during the winter months, displayed significantly less frequent shuttling behaviours, and showed higher variation in the proportion of the duration of daily activity above ground during this time compared to spring. Male Sungazers visited neighbour burrows significantly more frequently than did females but both sexes displayed high site fidelity. The findings of this study suggest that activity of a portion of the population of Sungazers during winter could be a behavioural response to infection. The increased movements of male Sungazers suggests that spring is the mating season of Sungazers. Finally, the development of the ACRSs have provided insightful

information on the activity patterns of Sungazers and the results suggest that Sungazers display seasonal variation in terms of activity. The ACRSs were able to function maintenance free for the duration of the study period and can easily be adapted to studies on other animals.

**Key Words:** activity patterns, automated reader systems, RFID technology, PIT tags, *Smaug giganteus*

# TABLE OF CONTENTS

|  |            |
|--|------------|
| <b>DECLARATION</b> .....   | <b>I</b>   |
| <b>DEDICATION</b> .....  | <b>II</b>  |
| <b>ACKNOWLEDGEMENTS</b> .....                                    | <b>III</b> |
| <b>ABSTRACT</b> .....  | <b>V</b>   |
| <b>CHAPTER 1: GENERAL INTRODUCTION</b> .....                     | <b>1</b>   |
| 1.1 ANIMAL TRACKING METHODS.....                                 | 1          |
| 1.1.1 Direct Observations .....                                  | 1          |
| 1.1.2 Capture-Mark-Recapture.....                                | 3          |
| 1.1.3 Radiotelemetry.....  | 4          |
| 1.1.4 Satellite Transmitters .....                               | 7          |
| 1.1.5 Geolocators.....   | 10         |
| 1.1.6 GPS and Smart Collars.....                                 | 11         |
| 1.1.7 Bioacoustic Monitoring.....                                | 12         |
| 1.1.8 Radio-frequency Identification.....                        | 14         |
| 1.2 ACTIVITY PATTERNS OF LIZARDS .....                           | 16         |
| 1.3 STUDY AIMS .....   | 16         |
| <b>CHAPTER 2: AUTOMATED CELLULAR PIT TAG READER SYSTEM</b> ..... | <b>17</b>  |
| 2.1 INTRODUCTION .....   | 17         |
| 2.1.1 The RFID System .....                                      | 17         |
| 2.1.1.1 <i>The Interrogator</i> .....                            | 18         |
| 2.1.1.2 <i>The Transponder</i> .....                             | 19         |
| 2.1.2 The Use of PITs.....                                       | 20         |
| 2.1.3 Automated Systems .....                                    | 20         |
| 2.2 METHODS AND DESIGN .....                                     | 21         |
| 2.2.1 FDX-A PITs .....   | 21         |
| 2.2.2 Automated Cellular Reader System (ACRS) Development.....   | 22         |
| 2.2.3 Power Source.....  | 23         |
| 2.2.4 Capturing Data.....  | 24         |
| 2.2.5 Environmental Hazards Safety.....                          | 25         |
| 2.2.6 Human-induced Hazards Safety .....                         | 25         |



|   |           |
|---|-----------|
| 2.2.7 Field Setup.....                                    | 26        |
| 2.2.8 Data Analysis.....                                  | 27        |
| 2.3 RESULTS .....   | 27        |
| 2.3.1 Data Capturing Success.....                         | 27        |
| 2.3.1.1 <i>Time Reporting</i> .....                       | 27        |
| 2.3.1.2 <i>Date Reporting</i> .....                       | 28        |
| 2.3.1.3 <i>Delayed Reporting</i> .....                    | 28        |
| 2.3.2 ACRS Field Durability.....                          | 28        |
| 2.4 DISCUSSION.....                                       | 28        |
| <b>CHAPTER 3: ACTIVITY PATTERNS OF THE SUNGAZER.....</b>  | <b>32</b> |
| 3.1 INTRODUCTION .....                                    | 32        |
| 3.1.1 Activity Patterns .....                             | 32        |
| 3.1.2 Introduction to the Species.....                    | 34        |
| 3.1.3 Distribution and Habitat.....                       | 35        |
| 3.1.4 Limitations to Previous Sungazer Research.....      | 35        |
| 3.2 METHODS.....  | 36        |
| 3.2.1 Study Site .....                                    | 36        |
| 3.2.2 Experimental Design and Protocol .....              | 37        |
| 3.2.2.1 <i>Sungazer Capture and Release</i> .....         | 37        |
| 3.2.2.2 <i>Reader Deployment</i> .....                    | 37        |
| 3.2.3 Data Analysis.....                                  | 38        |
| 3.2.3.1 <i>Data Processing</i> .....                      | 38        |
| 3.2.3.2 <i>Burrow Fidelity and Lizard Movements</i> ..... | 39        |
| 3.2.3.3 <i>Shuttling Behaviour Assessment</i> .....       | 39        |
| 3.2.3.4 <i>Time Activity Assessment</i> .....             | 39        |
| 3.3 RESULTS .....   | 40        |
| 3.3.1 Burrow Fidelity and Movement Patterns .....         | 40        |
| 3.3.2 Shuttling Behaviour .....                           | 41        |
| 3.3.3 Time Spent Active .....                             | 43        |
| 3.4 DISCUSSION.....                                       | 45        |
| <b>CHAPTER 4: GENERAL DISCUSSION AND CONCLUSION.....</b>  | <b>50</b> |
| 4.1 GENERAL OVERVIEW .....                                | 50        |
| 4.2 LIMITATIONS AND RECOMMENDATIONS .....                 | 53        |

|                           |           |
|---------------------------|-----------|
| 4.3 FUTURE RESEARCH ..... | 54        |
| 4.4 CONCLUSION.....       | 54        |
| <b>REFERENCES.....</b>    | <b>56</b> |

## CHAPTER 1

### General Introduction

*Introduction to tracking systems and their uses in recording wildlife activities*

---

#### **1.1 ANIMAL TRACKING METHODS**

For decades, researchers have been interested in tracking animals to monitor activity and movement patterns of both individuals and populations. While the conventional method of recording animal behaviour has been through direct observations both in field biology and laboratory studies, advances in technology have expanded and revolutionized ecological research. Technology has enabled researchers to monitor the activity patterns and behaviours of animals on both long- and short-term scales, maximizing research output in vertebrate and invertebrate biology fields. Research has transitioned from direct observations to collect data (e.g. Garson 1975), to capture-mark-recapture (CMR; e.g. Pradel 1996) techniques and more recently, radiotelemetry (e.g. Cooke et al. 2004), satellite transmitters (e.g. Weimerskirch et al. 2000), geolocators (e.g. Stutchbury et al. 2009), bioacoustics monitoring (e.g. Blumstein et al. 2011), and radio-frequency identification (RFID; e.g. Boarman et al. 1998), among others. In light of these technological advances, this chapter focuses on reviewing the history of tracking systems to monitor animal behaviour, including the associated advantages and disadvantages.

##### ***1.1.1 Direct Observations***

The conventional method of observing animal behaviour is through direct observation, where researchers watch a group of animals and note their behaviours. Without the current technological advances, direct observation to record animal activity and behaviour, especially in field-based research, was the only viable option. Garson (1975) showed, through a study on social interactions of Woodmice (*Apodemus sylvaticus*), that the direct observation method was a useful technique to study social organizations in the wild. Garson (1975) observed the Woodmice at night and used a red light and telescope to observe the animals, in an attempt to limit the consequences of being close to the animals, and reported that the animals were not affected by the light. In another two studies on Sungazers (*Smaug giganteus*), Van Wyk (1992) and Ruddock (2000) both used telescopes to observe the activity patterns and movement patterns of the species, respectively. While both studies provided useful information on the movement patterns and season variation of activity patterns and

concluded that individual Sungazers generally remain active in and around their home burrows, both studies and Garson's (1975) have logistical implications. For example, difficulty arises when attempting to observe behaviours and movement patterns of multiple individuals. Additionally, observing individuals in the field means that the study can become costly through extended periods of observation time. Nevertheless, through direct observations, insights into animal behaviour and activity can be provided.

The direct observational method has proven useful in the description of foraging modes of reptiles, especially for lizards. By using focal animal analysis to observe Kalahari lacertid lizards for at least one minute during the summer, Huey & Pianka (1981) were able to classify the lizards into one of two foraging modes: ambush foragers where lizards sit and wait for prey to pass by, and active foragers, where lizards actively search for food. To ensure standard measurement, the study used the same observer to visually estimate the distances moved as well as the duration of each move from each species (Huey & Pianka 1981). The visual observations were translated into moves per minute and proportion of time spent moving. Kalahari lacertids were classed as ambush foragers if they moved fewer than two times per minute and spent less than 20% of their time moving, while active foragers moved more than two times per minute and spent more than 20% of their time moving (Huey & Pianka 1981). This was the first study to provide an in-depth analysis on the foraging modes of reptiles, and created a general framework for understanding foraging modes in general. Researchers have since applied the same methodology to other lizard families as they are likely to display different measures of movements according to their lifestyle (e.g. Cooper et al. 1997). Additionally, some studies have provided evidence that some species use both active and ambush foraging modes (example *Bradypodion pumilum*, Butler 2005), suggesting that there is potentially a continuum for foraging modes between the active and ambush foraging mode extremes.

While the direct observation method has a long history in scientific research, it is still used. Researchers have enhanced the outcomes of the direct observation method through the use of photography and videography since the 1990s (e.g. Kucera & Barrett 1993). Remote photography has been extensively used in the field of avian ecology, specifically to monitor nesting behaviour and nest predation, as well as feeding regimes within the nest (reviewed by Cutler & Don 1999). Additionally, remote photography can be used to monitor activity patterns. For example, Stanton-Jones et al. (under review), used camera traps to record the

body postures and orientations employed by Sungazers. The camera traps were installed outside the burrows of Sungazers and set to record a photograph every minute of the day when Sungazers were active. A further advantage of photography and videography observations, to record animal behaviour is the potential to record extraordinary behaviours of animals (e.g. Glaudas & Alexander 2017). Through videography, Glaudas & Alexander (2017) documented, for the first time, two types of luring behaviour (lingual and caudal luring) exhibited by Puff adders (*Bitis arietans*). The study made use of fixed videography, where closed-circuit television (CCTV) cameras were installed in front of Puff adders in ambush. Along with the above advantages, photography and videography are less costly and time-consuming to researchers and are also less invasive to the animals under study. However, it is possible that camera equipment could impact animal behaviour (Cutler & Don 1999), and storage and utilization time is limited by memory card size and battery power, respectively. Regardless, photography and videography has certainly enhanced field ecology research and are often used in conjunction with other tracking methods, e.g. radiotelemetry (Glaudas & Alexander 2017).

### ***1.1.2 Capture-Mark-Recapture***

Capture-mark-recapture (CMR) techniques involve the process of capturing, marking (tagging), releasing, and recapturing animals through repeated sampling (Pradel 1996). The associated benefits of using the CMR technique in ecological research is that it provides quantitative estimates of animal populations and survival rates of those populations. Additionally, the CMR technique can provide information on the growth rates of animals (Pradel 1996) as well as foraging behaviours (Grace 1990). However, CMR can present limitations to studies where there is a low recapture success rate and therefore CMR methods are especially useful when there is a high recapture success rate of marked individuals.

To achieve the most valuable results from the CMR technique, animals need to be tagged effectively, which in itself may be a difficult task as tagging methods may be species specific. Nowicki et al. (2008) used a code method of punched holes into the most durable regions of adult crayfish to estimate population size. The method proved useful since the marks lasted for more than a year. Unfortunately Nowicki et al.'s (2008) method of tagging was not a permanent method but sufficed for the study. However, it should be noted that the punched hole method is invasive and cannot be used on juvenile crayfish as the marking technique causes a reduction in growth rates (Guan 1997). Another method that has proved successful

in tagging crustaceans is the use of coded microwire tags. The tags are injected into the ventral abdominal muscle and this method offers a more permanent tagging solution (see Sharp et al. 2000 for an example). However, it is also possible that this method can increase mortality and reduce growth rates (Brown and Caputi 1985). Many methods of tagging crustaceans fail since the tags that are used, if not invasive, are generally affixed to the animal's exoskeleton which is problematic as crustaceans regularly undergo ecdysis resulting in the loss of a tag. Although the punched hole method and coded microwire tags are acceptable methods of tagging crustaceans (Guan 1997, Sharp et al. 2000, Nowick et al. 2008), they are invasive and pose physiological risks to the animals.

Although it may be difficult to tag crustaceans, tagging terrestrial invertebrates is comparatively easy and less invasive. Grace (1990) investigated the foraging territories of eastern subterranean termites using a red dietary (food) dye and was able to accurately estimate the termite populations at different sites and measure the foraging distance for colonies. Another study used the CMR technique in a non-conventional way (Turchin & Thoeny 1993), as it addressed the intraforest dispersal of southern pine beetles. Additionally, they used a non-invasive technique to tag the beetles: pines infested with southern pine beetles were cut into sections and coated with a fluorescent pigment and the beetles marked themselves by walking over the fluorescent coating upon emergence from the pines (Turchin & Thoeny 1993). Their method of tagging the invertebrates in their study proved to be successful and Turchin & Thoeny (1993) were able to accurately measure intra-forest dispersal of the species.

### ***1.1.3 Radiotelemetry***

Further technological advances have resulted in the development of radiotelemetric equipment. Radiotelemetry is the most commonly-used method of monitoring animal activity (reviewed in Cooke et al. 2004; Ropert-Coudert & Wilson 2005), as it allows researchers to quantify animal movements, estimate population size, estimate home range sizes, identify habitat preference and get measures of survival, all of which are parameters that are difficult to measure through other techniques such as direct observation or even via CMR. In radiotelemetric studies, animals are marked with antenna-fixed tags, bands or collars, and traditionally, researchers carry a handheld radio receiver that receives the radio-frequency of transmitter in the tagged individuals, enabling researchers to locate individuals in their natural environment. More recently, however, autonomous receivers have been developed

(Cooke et al. 2004; Kays et al. 2011), with the primary focus for monitoring large-bodied animals (e.g. Mennill et al. 2012). The added advantage of autonomous radiotelemetry is that researchers do not need to be present to monitor the animals, although this may mean that behavioural and microhabitat data are not collected.

Radiotelemetry is often used concurrently with other methods of tracking animals. For example, Dillon & Kelly (2008) compared the use of radiotelemetry against camera trapping to estimate the home range size of ocelots (*Leopardus pardalis*), and found that camera trapping alone overestimated home range size and thus radiotelemetry provides a more realistic estimate. Glaudas & Alexander (2017) also used radiotelemetry to locate the puff adders in their study that were being monitored by fixed videography, providing an example of how researchers are employing a combination of tracking techniques to monitor animal behaviours. Powell et al. (2000) developed a model that combines the use of radiotelemetry and CMR to reduce biased estimates of survival and movement patterns in animals. A study on wood thrushes (*Hylocichla mustelina*) showed that estimates of recapture and movement rates were improved when the data were combined (Powell et al. 2000). However, the study suggested that further studies using the model should have a sample size of not less than 25 individuals. By comparing CMR and radiotelemetry, Powell et al. (2000) found no significant differences in estimating survival rates of wood thrushes. Another study on the spatial ecology of the Namaqua dwarf adder (*Bitis schneideri*), compared the same techniques and found no significant differences in daily movement pattern estimates (Maritz & Alexander 2012a). Thus, the measures from only radiotelemetry from a study on the mortality of yellow-spotted Goannas (*Varanus panoptes*) remains accurate (Ujvari & Madsen 2009). Ujvari & Madsen (2009) reported that after an invasion of cane toads (*Rhinella marina*) and after ingestion, yellow-spotted Goannas showed a significant increase in mortality rate. Thus, following advances in technology, estimations of movements, recapture data, home range sizes and mortality rates are improved, and models combining the datasets result in more accurate estimations.

Studies that monitor reptile movements, behaviours, home range sizes and survival generally employ the CMR technique. The implication is that the data received is often ambiguous and difficulty arises when trying to relocate free-ranging reptiles, especially snakes (Madsen 1984). Due to this limitation, herpetological studies have moved towards radiotelemetry (e.g. Madsen 1984, Blouin-Demers & Weatherhead 2001), or a combination of radiotelemetry and

CMR techniques (e.g. Maritz & Alexander 2012a). A study on grass snakes (*Natrix natrix*) used radiotelemetry to describe the species habitat use, home range size and movements through their natural environment (Madsen 1984). The study found that grass snakes typically inhabit stone fences, blueberry and blackberry bushes but home range estimates of the species was dependent on the number of tracking days (Madsen 1984). Another study also used radiotelemetry to monitor habit use by black rat snakes (*Elaphe obsoleta obsoleta*) and found that the species uses edge habitats because those habitats facilitate thermoregulation (Blouin-Demers & Weatherhead 2001). Fair & Henke (1999) also assessed survival, movements and home ranges in the Texas horned lizard (*Phrynosoma cornutum*) through radiotelemetry and found that home ranges decreased considerably as the lizards approached their hibernation period and that the annual survival rate exhibited a 9-54% range. Additionally, Maritz & Alexander (2012b) combined the use of the CMR technique with radiotelemetry to accurately report on survival estimates and population densities of the Namaqua dwarf adder (*Bitis schneideri*). Their study showed how effective the combination of CMR and radiotelemetry is at assessing ecological components of cryptic species. Radiotelemetry has therefore improved herpetological studies, particularly by enabling researchers to more accurately quantify movements, habitat use, population estimates and survival rates, but number of tracking days is essential to accurately estimate home range sizes.

Radio transmitters are not only used to evaluate an animal's ecology, but can also be used to assess physiological traits such as thermoregulation. Temperature-sensitive radio transmitters require the researcher to count the pulses emitted by the transmitters to measure an animals body temperature (e.g. Row & Blouin-Demers 2006). Christian & Weavers (1996) inserted temperature probes into the cloacas of varanid lizards to record measures of body temperature at fixed intervals and the transmitter was fixed to the base of the tail, on one of the sides. Row & Blouin-Demers (2006) used calculations of time per 10 pulses to measure the  $T_b$  of the milk snakes in their study. As a result, temperature-sensitive radio transmitters, although requiring pulse calculations, have enhanced studies on reptile thermoregulation, thus avoiding one of the standard mechanisms of recording  $T_b$ , known as the 'grab and stab' technique in which a researcher would catch an animal and immedialy record  $T_b$  by inserting a thermocouple into the cloaca.



While radiotelemetry has certainly enhanced research, there are limitations. One of the major limitations is that attachment techniques are variable among species and difficult to implement (Knapp & Owens 2005), especially on small species. Additionally, a study on salmon assessed the regurgitation rates of gastrically implanted radio transmitters and found that while a relatively low rate (10.9%) of regurgitation existed, there was a low recapture-rate of the tagged salmon (19.5%; Keefer et al. 2004). To overcome regurgitation, Keefer et al. (2004) suggested that a rubber band or a ring of surgical tubing be fitted to each transmitter. In studies of ectothermic species, if temperature radio transmitters, which require cloacal insertion of the temperature probes, are used, there is the risk of the temperature probe being dislodged from the cloacas (e.g. Christian & Weavers 1996). Some studies overcome external transmitter loss through the surgical implantation of radio transmitters, however, not only does this method place the animal under stress, but also include associated veterinary costs to the researcher. There is also the cost of the tagged animals under study being preyed upon, resulting in a loss of data. Additionally, radiotelemetry operates within the VHF (very high frequency) range and as a result, difficulty arises when attempting to monitor animals that move large distances daily or for those inhabiting mountainous areas as signal is limited, resulting in incomplete or small datasets (Fancy et al. 1988). However, although there are associated costs with radiotelemetry, the advantages are extensive and the technology has become increasingly popular.

#### ***1.1.4 Satellite Transmitters***

Satellite telemetry has been a recognized means for tracking animals and recording physiological data for decades. However, the technology only advanced in the 1980s when the transmitters had a small-enough construction for use on animals (Fancy et al. 1988). Although, investigation of the technology initiated in the 1970s by the U.S. Fish and Wildlife Service where the Nimbus satellite system was used to track polar bears (Kolz et al. 1980). Since that study, a breakthrough in the ability to track animals via satellite transmitters was made possible especially since the Argos Data Collection and Location System (DCLS) and the development of high power-density batteries became available (Fancy et al. 1988). The Argos DCLS has revolutionised environmental research with its ability to record environmental data periodically. Meteorological, hydrological, and ecological data, among others, are collected periodically through the Argos system via transmitters that are fixed to drifting ice, buoys, landsites, and recently, animals (Fancy et al. 1988). Transmitter signals are received by polar-orbiting satellites where the data are then transferred to processing

centres where distribution of the data to researchers occurs (Fancy et al. 1988). While most of the transmitters that are found on landsites or on the oceans are large, the limitation is that for the use on animals, they need to be small and light enough so as to not have an impact on the animal. Additionally, for use on animals, the transmitters need to be able to withstand abrasion, shock, submersion in water and extreme temperatures (Fancy et al. 1988). Nevertheless, satellite transmitters have made it possible for researchers to monitor animal movements over long distances, as well as on a long-term scale, thus overcoming the limitation that radiotelemetry may possess.

In light of the implications that radiotelemetry possesses for long-distance animal movements, satellite transmitters are instead being used, especially for aquatic animals and birds that invest time in annual migrations. Narwhals (*Monodon monocerus*), for example, were fitted with satellite transmitters such that movements could be monitored (Dietz & Heide-Jorgensen 1995). The study found that narwhals travelled southerly up to a distance of 700 km during their migration period where the ocean depths were 500-1000 m (Dietz & Heide-Jorgensen 1995). Another study assessed movements and diving behaviours of ringed seals (*Phoca hispida*) and found that after the formation of landfast ice, the two of the eight seals departed the study site for other locations (Teilmann et al. 1999). In addition, few seals remained within the study site and the water depth preferences were monitored and compared between sexes, where males showed a preference for waters deeper than 100 m and females showed a preference for shallower water, less than 100 m in depth (Teilmann et al. 1999). The seals were able to dive up to 250 m below the water surface and the females tended to conduct more frequent dives shallower than 50 m and males dove more frequently to depths that exceeded 50 m (Teilmann et al. 1999). Thus, the assessment of how far the narwhals travelled or the preference of water depths and diving behaviour by ringed seals would not have been possible or may have been difficult to assess through radiotelemetry, suggesting that satellite transmitters are effective tools to monitor large-scale movement patterns of migratory and diving animals.

Improvements to software and instrument design have resulted in satellite transmitters being used more routinely in animal tracking. For example, Weimerskirch et al. (2000) used satellite transmitters to monitor the influence of wind on albatros (*Diomedea exulans*) behaviour and energy expenditure. The study was able to estimate flight speed and activity patterns of the albatrosses from the satellite transmitters, and with an additional heart rate

transmitter, Weimerskirch et al. (2000) used heart rate as an index of energy expenditure in flying albatrosses. It is likely that attaching satellite transmitters could impact an animal's lifestyle, for example few studies on albatrosses have reported that post transmitter attachment resulted in an increased rate of nest desertion as well as an increase in trip duration (e.g. Brothers et al. 1998; Hedd et al. 2001; Nicholls et al. 2002). Another study had satellite transmitters abdominally implanted into murrelets and found that nesting behaviour was significantly altered following the implantation of satellite transmitters; where the breeding status of the implanted birds was not retained (Meyers et al. 1998). However, most other bird studies make use of externally-fixed transmitters that are a less invasive means of tagging an animal. Phillips et al. (2003) showed contradictory findings to Meyers et al. (1998), and the other studies by reporting no significant differences in albatross and petrel behaviour between tagged individuals and un-tagged individuals. While Phillips et al. (2003) found no significant differences in the individuals in their study, they acknowledged the fact that other studies had found effects of attached transmitters on albatrosses. As a result Phillips et al. (2003) suggested that harnesses for transmitter attachments be avoided, transmitter loads are to be kept to a minimum, and that handling times of the animals under study are kept to a minimum.

Satellite transmitters have also been used to monitor impacts of anthropogenic activities, especially fishing. Fishing activities have had a negative impact on sea turtles and Hays et al. (2003) used satellite transmitters fixed with salt-water switches (submergence completes the circuitry notifying the researcher that the turtles are still submerged) to deduce when sea turtles were removed from their environment. Evidence such as inland movements around villages or towns, sudden improvements to signal quality and information from the salt-water switches remaining open, suggested to the researchers that the sea turtles had been captured by fisherman (Hays et al. 2003). It is therefore evident that through the use of satellite transmitters, and a simple addition of a salt-water switch, researchers are better able to monitor the effects of anthropogenic activities such that conservation strategies can be implemented to minimize the harmful effects of anthropogenic activities, such as fishing. One of the major concerns regarding the use of satellite transmitters in animal studies is if the equipment has an impact on survival. Heggøy et al. (2017) found no evidence to suggest that backpack-mounted satellite transmitters affected mortality in snowy owls (*Bubo scandiacus*). In contrast, Dixon et al. (2016) found evidence to suggest that those same transmitters increased mortality in saker falcons (*Falco cherrug*). The effects of satellite transmitters on

mortality may be species specific but the potential for an increase in the likelihood of death to tagged individuals still exists. Despite the limitations, as previously stated, including the limited lifespan of batteries within the transmitters, durability and mass of satellite transmitters, the technology has certainly proven to be useful in studies on avian ecology as well as marine ecology. As the technology is becoming increasingly popular, the equipment continues to be further miniturised and more effective, and has the potential to become more applicable to studies on smaller, terrestrial vertebrates.

### ***1.1.5 Geolocators***

Geolocators are small light-sensor electronic tags that use ambient light from day and night lengths and local midday or midnight times to estimate an animal's longitude and latitude (Hill 1994). In addition, an internal clock is fitted to a geocator which is used in conjunction with the photoreceptors to accurately report a time-stamp upon retrieval of an animal's location (Hill 1994). Geolocators originated and were tested in the early 1990s on marine mammals whereby DeLong et al. (1992) used geolocators to study the movements and migrations of northern elephant seals. Since that initial use, geolocators have transitioned into studying the movements and migrations of other marine life and particularly movements of migratory birds. Like satellite transmitters, geolocators are used to study animal movements over long-distances and over long-time periods. As an alternative to other tracking systems, geolocators are small, light-weight, have a long durability and are cost-effective; and as a result, studies on migratory birds are increasingly using geolocators. One of the biggest limitations that geolocators overcome as opposed to satellite transmitters is their small size. Having a small construction enhances research capabilities and limits impacts to tagged individuals. Stutchbury et al. (2009) made use the small construction of geolocators in their assessment on migration behaviour and wintering locations of song birds. The study highlighted that previous studies on song birds underestimated migration speed (Stutchbury et al. 2009), suggesting that geolocators have greatly enhanced the tracking ability of researchers for migratory animals. Another study on the great reed warbler (*Acrocephalus arundinaceus*) also assessed migratory strategies in the species using geolocators mounted to the birds back with leg-loop harnesses, and found that the species has regular stop-overs across scattered sites (Lemke et al. 2013). What both of the above studies fail to mention is the implications that geocator attachments had on the species in the studies, however, they note that geolocators are effective tools in monitoring migratory behaviour in animals.

Since their development, many studies have assessed the effects of fitting geolocators to animals, especially birds, and the results are controversial. An impactful conservation study on the effects of marine pollution on northern gannets (*Morus bassanus*) found that the latitude estimates of light-sensor geolocators were reduced and could not be measured during solar equinoxes (Montevecchi et al. 2012). Latitude estimates had to be corrected using sea surface temperature measures received by remote satellites. Fortunately, the study also used satellite transmitters which provided more accurate estimates of the individuals positions (Montevecchi et al. 2012). Additionally, the study found that there were occasionally unrealistic migratory speeds as recorded by the geolocators (Montevecchi et al. 2012), forcing those data records to be discarded. This finding questions the integrity of the equipment and findings in other studies (e.g. Stutchbury et al. 2009). Other studies have also found that there are negative effects of geolocators on fitness and ecological components, especially survival (Costantini & Møller 2013) and stress (Elliott et al. 2012). A study on lesser kestrels (*Falco naumanni*) found that although there were no harmful effects on the birds during the breeding season of tagged individuals, the fledglings experienced greater mortality during the following breeding season (Rodríguez et al. 2009). Although the use of geolocators has opened up more research windows for migratory species, the effects of the tags can be problematic, fitment of the tags onto individuals needs to be considered carefully (Rodríguez et al. 2009), and the interpretation of the results needs to be approached with caution.

#### **1.1.6 GPS and SMART Collars**

Technological advancements have made it possible for collars to be fitted onto animals, that are able to record several datastreams to answer specific questions relating to an animals biology. One of the most commonly-used variations have been radio-collars in which researchers actively track an animal by using a handheld receiver. While radio-collars were and are still useful in current studies, recent technology has allowed for the development of GPS and SMART (species movement, acceleration, and radio-tracking) collars, creating an opportunity to assess animal behaviour at a finer temporal resolution and to answer questions relating to the energetics of animals, particularly medium and large terrestrial mammals (e.g. Williams et al. 2014; Hubel et al. 2016).

Tracking collars have been modified to meet the requirements of particular studies. For example, Wilson et al. (2013) designed a tracking collar, fitted with a GPS and inertial measurement units (IMU), to monitor the locomotor and hunting dynamics of cheetahs. The technology provided an assessment on acceleration, travel speed and body mass-specific power of cheetahs while hunting, accounting for the first detailed information on the locomotor characteristics of hunting dynamics for a large predator (Wilson et al. 2013). The development of the system was subsequently further developed by Hubel et al. (2016) employing the GPS and IMU collars to record the hunting dynamics of African wild dogs. Additionally, the study was expanded with the use of an energy balance model to assess the energetics of the wild dogs, which was also compared to those of cheetahs (Hubel et al. 2016). The advantage of the GPS and IMU collars combined with the energy balance model provided evidence that the energetics of African wild dogs are far more robust than previously thought (Hubel et al. 2016). Similarly, Williams et al. (2014) developed a SMART collar but used oxygen consumption and kinematics correlated to acceleration signatures from the SMART collars to measure the energetics of pumas (*Puma concolor*). As a result, the outcomes of both Hubel et al. (2016) and Williams et al. (2014), provides evidence for the demands of resources for hunting animals. Thus, the use of GPS and IMU collars and SMART collars are likely to gain popularity, specifically to broaden scientific knowledge on the hunting dynamics and resource demands of free-ranging animals.

Although GPS and IMU collars and SMART collars have facilitated the study of large predators, their use on smaller animals remains limited. However, I predict that with further developments and devices continuously decreasing in size, that GPS and IUM collars and SMART collars will be modified to provide some benefit for use small mammal and reptile studies.

### ***1.1.7 Bioacoustic Monitoring***

Most technologies used to track animals require individuals to be captured and tagged by some piece of equipment, but technology has evolved to the extent of enabling researchers to use the sounds produced by animals to answer a diverse array of biological questions. Animals use their own sounds to serve a variety of different biological functions ranging from territory defence, predator awareness, foraging, communication, and mate attraction, among others. Bioacoustic monitoring occasionally involves the process of broadcasting animal sounds and recording the number of responses. Recording responses enables

researchers to gather information about the population density within a location. While Conway & Gibbs (2005) found that the number of responses were increased after species-specific sounds were broadcasted, they highlighted that the broadcasting of sounds has the potential to reduce the number of responses in other species. In addition, microphones are used to monitor the sounds of different animals where a single microphone has been used to assess species richness in many different animal groups (see Blumstein et al. 2011 for a review). More recently, however, arrays of microphones have been used to track animals at a fine-scaled resolution and is advantageous as the setup does not require individuals to be marked (Blumstein et al. 2011; Measey et al. 2017).

With a combination of at least three microphones, that are spatially diverse, and localization algorithms, researchers are able to pinpoint the source of sounds, and hence the individual emitting those sounds (Blumstein et al. 2011). Additionally, an increase in the number of microphones and arrays result in an increase in accuracy of an animals position (Collier et al. 2010; Kirschel et al. 2011; Measey et al. 2017). Collier et al. (2010) found that after using 32 microphones to study the localization of antthrushes (*Formicarius moniliger*), the accuracy of the animals position was within 50 cm of the individuals actual position. An older study by McGregor et al. (1997) also suggested that location identification is affected by the distance between the source of the sound and the array. Thus, the closer the arrays are to known individuals, the more accurate the arrays will be in assessing the position of the individuals. Additionally, Measey et al. (2017) suggested that time of arrival of calls to microphones, and signal strength of the microphones are important factors that enhance the detectability of an individuals location. Since it is often difficult for researchers to use visually-oriented technologies to detect rare species, the use of microphone arrays has overcome that limitation. For example, with more than 40 000 hours of acoustic monitoring, studies showed that the previously thought-to-be-extinct ivory-billed woodpecker (*Campephilus principalis*), still inhabits bottomland forests (Arkansas; Fitzpatrick et al. 2005) and the Florida panhandle (Hill et al. 2006). Improved accuracy to detect location from multiple arrays suggests that a large set of microphone arrays has the potential to estimate population densities, territorial dynamics as well as habitat use, at not just the level of the individual but also at the level of the population (Blumstein et al. 2011).

While, the efficacy of microphone arrays in assessing an animals position is high, there are limitations to the methodology. Having multiple microphones becomes expensive, difficult to

carry to study sites, especially in remote locations that are difficult to get to, and often arrays need to be custom-built. Additionally, microphone arrays often require extensive cable layout throughout the study-site, making it difficult to install. With these limitations in mind, Mennill et al. (2012a) tested a new system of microphone arrays that operates wirelessly, is small and is fitted with a global positioning system (GPS) to synchronize the time of the microphones. Mennill et al. (2012a) tested the wireless systems ability to record 25 different species, including birds, frogs and mammals, across 12 sites using only four microphones and found that the system produced a location accuracy of within 2 m of an animals location. Although the finding was similar to most cable microphone arrays, the efficacy was relatively high considering only four microphones were used. Like McGregor et al. (1997), Mennill et al. (2012a) also found that location accuracy detection was improved when the microphones were in close proximity to each other and when they were closer to the sound source. This new wireless system therefore reduces the need for expensive, cumbersome equipment and can accurately locate an animals position.

Microphone arrays have many advantages in studies on birds, mammals and frogs. However, in animals, such as reptiles, where vocal communication is not common, the equipment is ineffective. Although there are associated limitations such as the cumbersome, expensive equipment, associated with cable microphone array systems, technological advances has reduced the size and need for cables, producing similar location accuracy results. Therefore, biacoustic monitoring is a highly effective tool in monitoring animal locations, population densities and has the ability to assess the status of thought to be extinct animals. With specific reference to the wireless microphone array system, there is the potential to significantly enhance wild-life research.

### ***1.1.8 Radio Frequency Identification***

Radio-frequency Identification (RFID) has been increasingly used to monitor a large network of biological functions in animals. The RFID system is typically composed of two main components, a transponder tag and an interrogator (reader) whereby the reader generates an electromagnetic field, powering the transponder tag, giving unique identification to the subject (Lozano-Nieto 2010; Pradhan et al. 2013). For the purpose of reducing repetition, this section will be brief and touch on some of the implementations of the RFID system in terms of animal research, as this section has an in-depth discussion in Chapter 2.



Passive Integrated Transponder tags (PITs) are the most commonly used transponders for tagged wildlife. PITs are encapsulated in a biocompatible glass housing (Boarman et al. 1998) and a simple injection procedure allows researchers to tag individuals sub-cutaneously, minimizing stress to the animal and avoiding surgical costs of other tagging methods, as in radiotelemetry. A PIT gives an individual animal a unique identification (ID) code which allows researchers to track and monitor movements of animals from recapture analyses (reviewed Gibbons & Andrews 2004) or through automated reader systems (e.g. Boarman et al. 1998). As a method for controlling imports and exports of wildlife, PITs have been used by CITES (Conference on International Trade in Endangered Species) to monitor the illegal animal trades (Zulich et al. 1992).

PITs have largely been used to monitor the movements of animals through either active systems or passive systems. An active system requires an animal to be recaptured and scanned for a tag using a handheld RFID reader whereas a passive system does not require the recapture of animals (see Chapter 2). Traditionally, PITs have been used to study fish movements (e.g. Prentice & Park 1983), but since then has transitioned into studies assessing the movements of other animals such as small mammals, birds, amphibians and reptiles. For example, Schulte et al. (2007), used PITs to assess the movement patterns adult fire salamanders (*Salamandra salamandra*). The study found that male salamanders were more likely to be recaptured compared to female salamanders suggesting that female salamanders display higher dispersion rates and lower site fidelity compared to males (Schulte et al. 2007). Another study monitored the activity of voles (*Microtus ochrogaster* and *M. pennsylvanicus*) in runways and found that sunrise and sunset were peak activity periods (Harper & Batzli 1996). Additionally, Harper & Batzli (1996), tagged the voles with both ear transponders and PITs but found that the risk of losing ear transponders was increased compared to PITs. However, there is still the potential to lose PITs through rejection and recently, biobond caps have been fitted to PITs to reduce the risk of tag rejection (Identipet 2017).

The use of autonomous or passive reader systems (ARS) has had a positive impact on movement ecology. The biggest advantage of autonomous system is that it avoids the need to recapture animals but the systems can be costly and requires the researcher to actively download data (see chapter 2). However, the use of ARSs has extended research capabilities of animals that move slowly or infrequently and has enabled researchers to study movements

of animals past specific points (e.g. Boarman et al. 1998). Despite the capabilities of an ARS, the design of the equipment seems to have stagnated.

## **1.2 ACTIVITY PATTERNS OF LIZARDS**

The activity patterns of lizards have been monitored using a range of different techniques. However, most studies tend to monitor lizard activity and movement patterns using the direct observation technique (Huey & Pianka 1981, Eifler et al. 2007, Zamora-Camacho et al. 2013). Through the direct observation technique, Huey & Pianka (1981) provided highly regarded work on the foraging modes of lizards which has since been applied to many other studies (see section 1.1.1). Although the CMR and direct observation techniques are still used in current research, few studies have made use of technological advancements to monitor lizard activity patterns. For example, Wone & Beauchamp (2003) fitted radio transmitters to horned lizards (*Phrynosoma mcalli*) to record the activity patterns, movement patterns and home range sizes of the species, and found differences between male and female lizards. Another study, developed an activity logger, fitted to the tails of the Australian sleepy lizards (*Tiliqua rugose*) which was able to record fine-scaled movement patterns such as the number of strides taken by the lizards and the duration of each stride (Kerr et al. 2004). Using their design, Kerr et al. (2004) were able to successfully monitor the activity patterns of the lizards in their study without the presence of an observer, therefore reducing the effects of an observer on a lizard's behaviour. However, their technique requires the lizard to be fitted with an external device for an extended period of time which could be detrimental to an individual at a long-term scale.

## **1.3 STUDY AIMS**

In this study, I designed and built a remote activity monitoring device that will remotely record and transmit information on emergence and retreat times and frequencies of the Sungazer (*Smaug giganteus*), which is covered in the following chapter (Chapter 2). Therein, I highlight the effectiveness of the system to report on Sungazer activities. Secondly, in Chapter 3, I used the system to monitor the activity and movement patterns of the Sungazer and compare the results across two seasons, winter and spring. Finally, the last chapter presents concluding remarks for the study. Because the two data chapters have been written in the style of stand-alone papers, this has resulted in some repetition.

## CHAPTER 2

### Automated Cellular PIT Tag Reader System

---

#### **2.1 INTRODUCTION**

##### ***2.1.1 The RFID System***

Radio-frequency Identification (RFID) is a technology that makes use of an electromagnetic field that enables communication between a terminal and an electronic tag that is generally attached to an object for the purpose of tracking and identification (Lozano-Nieto 2010; Pradhan et al. 2013). The use of RFID has gained momentum in recent years and many industries have benefitted from the wide uses that the technology has to offer: inventory control, asset management, security systems, keyless entry, automatic toll debiting and biological research – specifically the tracking of animals (Finkenzeller 2010, Pradhan et al. 2013). Prior to RFID technology, bar-code systems were used but unlike bar-code systems where there is a restricted range of unique IDs and which are not programmable (Finkenzeller 2010), RFID tags support a larger set of unique IDs, that are alphanumeric and are programmable. They also support a wider range of data types where many tags are now able to measure environmental temperatures (Want 2006). Additionally, the development of the technology has allowed for multiple tags to be read using a reader, which may be hand-held or automated (Want 2006), and both the tag and the reader are reusable as they are programmable (Pradhan et al. 2013).

A full RFID system comprises of just two main components, the transponder (tag) and the interrogator (reader) (Fig. 2.1, Want 2006, Finkenzeller 2010, Pradhan et al. 2013). The reader is an integrated circuit that stores and processes information, as well as modulates and demodulates the radio-frequency (Pradhan et al. 2013). Attached to the reader is an antenna that induces the electromagnetic field to transmit a modulated radio-frequency signal to the RFID tag which in turn is able to send unique information (Pradhan et al. 2013). Three variations of RFID tags exist: active tags, passive tags and battery-assisted passive tags (Want 2006, Pradhan et al. 2013). Active tags require a power source such as a battery but therefore has a lifespan which is determined by the battery. In contrast, passive tags do not require a battery and have an indefinite lifespan, and without the need of a battery they are cheaper, smaller and more practical (Want 2006). Additionally, passive tags are powered and transmit a signal when in an electromagnetic field that is generated by the reader (Want 2006,

Lozano-Nieto 2010, Pradhan et al. 2013). The reader requires a power source (battery) to operate. The battery-assisted passive tags make use of an external battery which is not only required to awaken the tag, but also enables the tag to have a much greater reading range (Pradhan et al. 2013). The limitation, however, is that the cost of battery-assisted passive tags are increased due to the need of a battery.

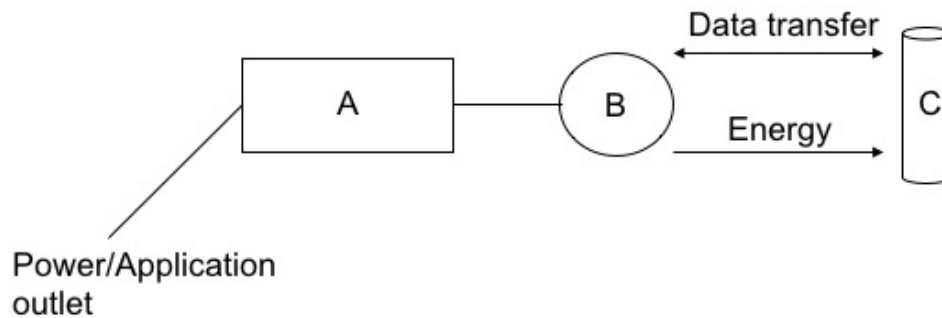

**Figure 2.1:** The main components of an RFID system are the reader (A), with an attached antenna (B) and the tag (C).

#### 2.1.1.1 The Interrogator

The interrogator, or reader, comes in various designs depending on the application: handheld or active readers and automated or passive readers, but the internal components are generally the same. Typically, the reader is fitted with a radio-frequency module, capable of transmitting and receiving radio-frequencies (Finkenzeller 2010). A control unit and antenna are also components of the reader, and automated readers are often fitted with additional interfaces such as an RS 232 or RS 485 component (both of which are differential communication systems), enabling them to transfer the received data from tags to an additional system, for example a datalogger, computer, cellphone engine or robot control system (Finkenzeller 2010). Additionally, the readers are tuned to a set frequency, often at a low frequency such as; 125, 132.4 or 400 KHz, and these frequencies match the frequencies of specific tags (Finkenzeller 2010). The reader powers and communicates with the tag, which lacks its own voltage supply. The communication between tags and readers is dependent on the size of the antenna, since the size of the antenna determines the read range of the tag (Pradhan et al. 2013). The larger the antenna, the greater the electromagnetic field and the greater the reading distance. Upon contact with a tag, the antenna of the reader generates an electromagnetic field causing the tag to wake up and transmit its unique ID (Want 2006, Finkenzeller 2010, Pradhan et al. 2013). After transmission of the tag's ID, the reader processes the information and if there is an additional system to view the information,

the reader transfers the information via the RS 232 or RS 485 component. Temperature and humidity sensors can also be connected to a reader and upon contact with a tag will also transfer temperature and humidity records to the datalogger.

#### *2.1.1.2 The Transponder*

The design of RFID transponders, or tags, may differ depending on the desired use of the tag, but generally all consist of the same internal components (microchip, antenna, chip-capacitor). What differs, however, is how the tag's circuitries and antennas are housed and protected from environmental conditions (Finkenzeller 2010). Typically, tag protection is achieved through encapsulation, which may be a laminar plastic with adhesive for attachment to goods, protection may even be through the use of epoxy resin or polystyrol (these tags are constructed into a disk; Boarman et al. 1998, Finkenzeller 2010), but in the field of animal tracking, encapsulation is a small glass vial (Boarman et al. 1998, Want 2006, Finkenzeller 2010). Since my study was associated with logging the activity patterns of lizards, I used the glass encapsulated tags and therefore a more detailed description of these tags is provided. Glass encapsulated tags are passive tags and are usually referred to as passive integrated transponder tags (PITs). Each PIT has the following construction: a thin (0.03 mm) wire coiled around a ferrite core, a microchip and chip-capacitor are housed in biocompatible glass (Boarman et al. 1998), facilitating safe subdermal implantation via injection or surgical means (Finkenzeller 2010). The above construction enables PITs to be small, generally only 12-32 mm in length and 2-4 mm in diameter (Boarman et al. 1998, Finkenzeller 2010). Additionally, PITs are also fixed with a Biobond® Antimigration Cap (Indentipet 2017), to reduce the risk of expulsion from the animal.

The biggest advantage that PITs have over other identification technologies is that they are permanent, can be housed within the animal and do not appear to be detrimental. However, to achieve this advantage, PITs need to be correctly implanted and animals must be of suitable body size. Studies have also shown that PITs are not a hindrance to an animal's physiological performance (i.e. growth rates, mating systems, swimming, running or flying capabilities, etc.; see Gibbons & Andrews 2004). Additionally, successful implantation of PITs does not negatively impact an animal on physiological or behavioural scales (Gibbons & Andrews 2004), and also reduces stress to the animal as automated systems (see section 2.1.3) can read tags without an animal needing to be captured. The added advantage of PITs is that they are

highly reliable, possessing a more than 95% successful detection rate and almost 100% reading accuracy (Gibbons & Andrews 2004).

### ***2.1.2 The Use of PITs***

For decades, PITs have been used in various wildlife studies. The first use began with ichthyological research (Prentice & Park 1983). Subsequently, the use of PITs has proved to be useful for capture-mark-recapture studies on mammals, birds, amphibians, reptiles, and even invertebrates (see Gibbons & Andrews 2004 for a review), where data on movement patterns, growth rates and home ranges can be collected. PITs are also used for veterinary purposes for tagging house pets and livestock (AVID 2003, Gibbons & Andrews 2004), for the purpose of identity and theft (particularly livestock) confirmation. Additionally, PITs have been used by CITES to monitor the illegal harvesting of animals (Zulich et al. 1992). The PITs are used to distinguish between captive-bred and wild-caught animals, where authorities use a database to hold records of all tagged animals. Therefore, even though PITs are instrumental in biological studies, they also serve as a useful conservation-monitoring tool.

### ***2.1.3 Automated Systems***

The development automated RFID reader systems (ARS) has received attention in biological studies where researchers have modified the systems to meet the specific requirements. The advantage of ARSs is that they can be used under laboratory conditions and field experiments, where animals are able to pass over or through the antenna system freely without the need for researchers to capture the animals. ARSs have been extensively used to monitor the movement patterns of fish in shallow streams (Roussel et al. 2000, Bond et al. 2007) as well as movements around hydroelectric dams (Prentice et al. 1990). This is advantageous over active designs where researcher would need to probe the water with an antenna to detect passing-by tagged-fish (Cucherousset et al. 2005). Since their initial uses in fish studies, ARSs have been successful in studies on small mammals such as voles (Harper & Batzli 1996) and bats (Kunz 2001), amphibians (Schulte et al. 2007) and even conservation research on reptiles (Boarman et al. 1998). Boarman et al. (1998) used a modified ARS to monitor the use of storm drain culverts by desert tortoises (*Gopherus agassizii*) with the future aim of identifying conservation strategies.

ARSs allow for the remote collection of data but need to be protected against environmental- and human-hazards for their use in field-based studies. Additionally, ARSs must run maintenance-free for extended times. Boarman et al. (1998) were the first to implement a safe, accurate and maintenance-free ARS on desert tortoises. To store data, Boarman et al. (1998) installed a datalogger into their ARSs. The data were then downloaded to a computer at a later stage. The use of ARSs has obvious advantages, but like any technological equipment, there are disadvantages. In studies where animals have large home ranges, ARSs may not be as effective if they are installed randomly within a study site as they may not detect all tagged-animals. It is therefore important for them to be installed in close proximity to where the tagged-animals are likely to visit. Additionally, for use in burrows or tunnels that have multiple entry and exit points, it is essential to place readers at all points (Boarman et al. 1998). This will also allow for directionality assessment in and out of tunnels. In general, however, ARSs have many advantages, including being relatively cost-effective and automated, but all limitations need to be considered and dealt with depending on the requirements of the study.

The aim of this chapter is to provide a detailed description of a newly designed automated PIT tag reading system that makes use of a cellphone engine to transfer data to a website. Herein, I describe a system termed an ‘Automated Cellular Reader System’ (ACRS) which is a completely passive reader system that captures the unique ID of a tag that has been implanted into an animal and immediately uploads the data to a secure website for remote viewing. The system ultimately provides researchers with remote access to data for tagged animals under study

## **2.2 METHODS AND DESIGN**

### ***2.2.1 FDX-A PITs***

The PITs used in this study complied with Full-duplex, annexure A (FDX-A) technology (Identipet 2017). In the FDX procedure, data transfer between the tag and the reader is simultaneous to data transfer between the reader and the tag (Finkenzeller 2010). The PITs are small (12 mm in length and 1.2 mm in diameter), have an average mass of 0.06 g, and are housed in a cylindrical biocompatible glass capsule. Additionally, these PITs have an operating frequency of 125 KHz and have a read range of 100-200 mm, depending on the FDX-A compliant reader (Identipet 2017). However, sensitivity is tag-specific with some

tags displaying a greater sensitivity than others. Presumably, this variation arises during the manufacturing process. I tested the sensitivity of each tag before implantation into a lizard using a hand-held FDX-A compliant reader and to ensure accurate data collection, only highly sensitive (> 100 mm read range) tags were implanted into the lizards.

### ***2.2.2 Automated Cellular Reader System (ACRS) Development***

I collaborated with Alex Bass from Bassix Audio to design an automated PIT tag reader that was capable of collecting data remotely and uploading those data to a website. A detailed description of the design is provided below.

Reader boards were constructed following the FDX-A protocol to ensure that they were capable of reading the FDX-A PITs. Readers were designed to read 125 KHz PITs and the antennas were tuned accordingly. The antennas were fixed to the reader boards and were designed to surround the entrances of Sungazer (*Smaug giganteus*) burrows. Sungazer burrows have an average entrance width of  $180 \pm 32$  mm with a maximum width of 330 mm (Van Wyk 1992). Thus, with respect to these dimensions a loop antenna (300 mm in diameter) was designed that could fit over the circumference of the burrow entrances. The antennas were tuned by winding the copper wire 15 times, and wrapping the loop antennas with insulation tape to ensure robustness and sensitivity. The lizards would pass directly through the loop upon exiting and entering their burrows.

Field observations have shown that Sungazers regularly perch at the entrance of their burrows (Van Wyk 1992). I thus designed software, installed in the reader board, to ensure that a lizard perched at their burrow entrance would have its unique ID read only once, preventing multiple records of a single event – defined by a tag passing through the loop antenna. The software operates with the following logic: upon contact between the antenna and a tag, a modulated carrier is formed, the lizards' unique ID would be read, and the system would pause until such time as an ID changes (different lizard passing through) or when the modulated carrier collapses. The modulated carrier collapses when a lizard moves off/away from the antenna or read range. Additionally, the reader boards were fitted with low drift capacitors to ensure that their functioning remains stable under high temperatures in the field.

A datalogger was installed onto the reader so that the information from the tags IDs could be stored. An RS 485 communication system was installed on the reader to facilitate this. The



advantage of the RS 485 system is that it allows for extended attachments of dataloggers, has immunity to electrical noise and allows for multiple connections to the reader board. I used a cellphone engine as the datalogger and this was programmed to transfer data recorded by the reader to a website containing a sequel database. Additionally, a circular buffer (memory allocation system to reuse memory) was programmed into each cellphone engine to allow storage for up to 16 different ID tags and for a single tag from the same reader to be posted to the website individually. Since the cellphone engines emit electromagnetic transmissions which would likely interfere with the antenna systems of the readers, the cellphone engine was connected to the RS 485 port of the reader using a cable, 750 mm in length, ensuring safe separation and preventing electromagnetic interference. A temperature and humidity combined sensor (AOSONG DHT11) was also built into each cellphone engine, so that ambient temperature (within  $\pm 2$  °C) and humidity (within  $\pm 5$  %) data could be posted simultaneously with a lizard's ID to the website database. All readers were tested in a laboratory setting by passing a tag through the loop antenna as to ensure that a lizard fitted with a tag would be recorded. Five different tags were used in the testing process prior to the deployment of the readers in the field.

### ***2.2.3 Power Source***

Since the study site was located in the open grasslands of South Africa, and the area receives intense solar radiation with very little shade cover, I used solar power to power the ACRS. I developed a main power box unit, suitable to connect up to four ACRSs. The power unit consisted of four main items, a rechargeable, Bosch 12 V 100 Ah lead-acid battery, a 50 W solar panel (SP-FG-50W), a 10 A solar charge controller (ECCO), and the three or four ACRSs. To ensure that the equipment was 'field setup' friendly, I designed a connection box (a water-tight plastic box), which contained and secured the solar controller (Fig. 2.2a). Inside the connection box, I extended the outputs of the solar charge controller such that plug-in connections from outside the connection box were possible and so that multiple ACRSs could be connected to the same controller (Fig. 2.2b). Connection of the solar panel and battery to the respective terminals of the connection box was made possible using plug-in connector leads (Fig. 2.2c). To enable multiple connection ports to the device output of the solar charge controller, I used three connection blocks – one for each ACRS. Finally, the connection box and battery were placed inside a sealed plastic box, on top of which the solar

panel was placed and secured, using steel rods, at an angle of approximately 30°, facing north.

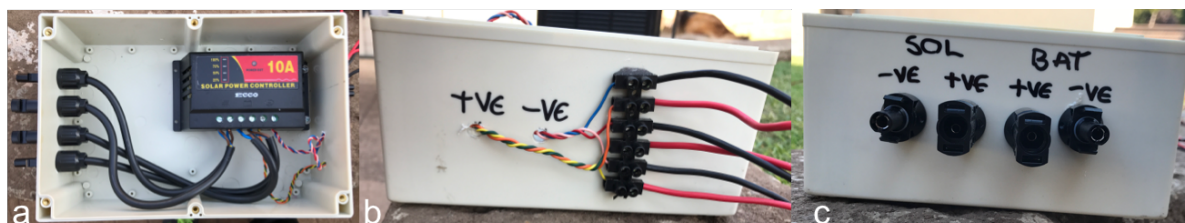

**Figure 2.2:** The connection box showing the solar controller (a), the connections for multiple ACRSs (b) and connections for the solar panel and battery (c).

### ***2.2.4 Capturing Data***

The system was designed to record data remotely and to send the data directly to a secured website with the use of cellphone engines. Individual cellphone engines were connected directly to the RFID reader circuitries using an RS 485 differential communication system. Each cellphone engine had a Vodacom SIM card installed and 100 mb of data loaded monthly for the duration of the study period so that the readers were able to post the information collected to the website database. Additionally, R12.00 mobile airtime was loaded monthly to each SIM card so that I could send an SMS to programme the readers and to monitor the status of each reader. In general, the ACRS works as follows: a lizard fitted with an implanted tag leaves/enters their burrow passing through the loop antenna which generates an electromagnetic field to wake the tag; thus it is essential for a marked lizard to pass through the loop antenna in order for the unique ID of the tag to be read and recorded. The tag's ID is decoded by the reader and stored in the circular buffer in the cellphone engine before being posted to the internet server. The lizard's ID along with the ambient temperature and humidity measures of the event is posted to the website. Each such event records the following data: record number (ID\_N), lizard PIT tag number (RFID no.), date and time, temperature and humidity at the time of the event, GPS coordinates of the poling cell tower, IMEI number of the SIM card, battery voltage and burrow number (Fig. 2.3).

## Rfid-Logger

| ID_N | Rfid No    | Date       | Time     | Temp | Humid | Latitude   | Longitude | IMI No          | Batt | Site Name |
|------|------------|------------|----------|------|-------|------------|-----------|-----------------|------|-----------|
| 5768 | 4062283A5A | 2017-11-18 | 06:34:34 | 13.0 | 47.0  | -27.475813 | 28.079901 | 862631032248733 | 10.4 | 1117      |
| 5767 | 4233574F47 | 2017-11-17 | 14:59:52 | 39.0 | 3.0   | -27.475813 | 28.079901 | 862631032258666 | 12.8 | 1127      |

**Figure 2.3:** An example of the database from the website containing the data of tagged lizards.

### 2.2.5 Environmental Hazards Safety

Since the study site was prone to environmental extremes such as high rainfall during the spring and summer months, and relatively high temperatures, the ACRS and power box unit was secured for protection. Firstly, the copper-coiled, loop antenna was wrapped in insulation tape, and once fitted and moulded to the shape of a burrow entrance, were secured to the ground using an iron nail and string for protection against removal that could be caused from the free-roaming ungulates. The electronic components (i.e. the reader board and cellphone engine circuitry) were each fixed inside of their own water-tight plastic containers (Fig. 2.4). Additionally, the entry and exit points of each container for all the ACRSs were sealed using heat-gun glue. Lastly, the battery and connection box were protected against environmental hazards by being placed inside of a sealed plastic container, and the ports for the ACRS wire entry were sealed shut using duct tape, upon completion of the ACRSs deployment.

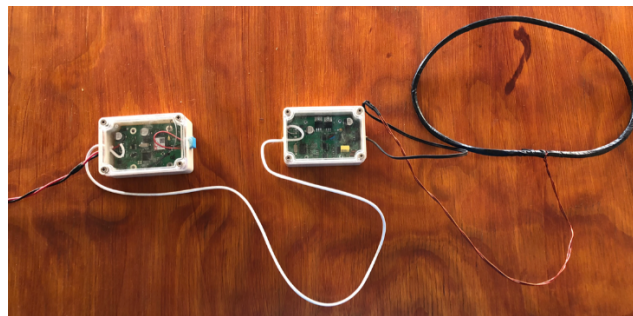

**Figure 2.4:** The Automated Cellular Reader System (ACRS) showing the housing of the cellphone engine (left), reader board (right) and the attached antenna.

### 2.2.6 Human-induced Hazards Safety

Since the ACRSs were deployed on open grasslands, there was always the risk of theft. To minimize this risk, I selected a privately-owned farmland and I stayed in regular communication with the farm manager who routinely checked the systems whilst they were deployed. Additionally, the plastic containers containing the batteries and connection boxes,

were green to aid in camouflage with the grass. All wires from the electronic components were also buried amongst the thick, long grass, to further aid in camouflaging the systems. Solar panels could not be hidden.

### **2.2.7 Field Set Up**

A total of 12 ACRSs were built and installed among four burrow clusters within three aggregations of three or four lizard burrows. Within the one larger aggregation, two power units for the ACRSs had to be installed as a result of the greater distances between burrows. At both of these burrow clusters, the three ACRSs were installed at three respective burrows. One power unit was set up at each burrow cluster within each of the other two smaller aggregations where four ACRSs were installed at four burrows within the one colony and two ACRSs at two burrows within the other colony. Setup of the ACRSs consisted of installing the main power box unit central to the burrows within a cluster and the readers were installed at the respective burrows (Fig. 2.5). The loop antennae of the readers were fixed around the circumference of the burrow entrances, and the reader and cellphone engine circuitry boxes were placed above, on the ground, of the burrow entrances. Since the burrows were not equidistant from the main power box unit, the connection leads were extended from the readers and connected to the connection box inside of the main power box unit.



**Figure 2.5:** Field set up of the ACRS and power supply system. The antenna (a) is fitted over the burrow entrance, followed by placement of the reader board (b), then the cellphone engine (c) and the power box unit (d).

### ***2.2.8 Data Analysis***

The data success rate of the ACRSs was calculated by calculating the percentage of accurate posts from the reader. This was converted to a percentage of records that accurately reported the time of an event as well the date of the event. Inaccurate time records included measures of time that were reported as a morning time instead of an afternoon time, or vice versa, and inaccurate date records included measures whereby dates were either not reported or reported with a different year to which the study was conducted. Additionally, percentage of records that were delayed was also calculated, and a delayed record was measured by instances of activities being reported in the afternoon time periods instead of morning periods, but still retaining the initial time of the actual events of lizards either leaving or re-entering their burrows (the data was stored within the circular buffer and posted to the website upon the system acquiring adequate network reception for internet connectivity). ACRS field durability was assessed by quantifying how many systems endured structural damage to the any of the components, including the housing in relation to days deployed.

## **2.3 RESULTS**

### ***2.3.1 Data Capturing Success***

A total of 58 lizards were tagged with PITs in this study. The 12 ACRSs had an overall success rate of 98.5 % in their ability to accurately report instances of Sungazer activity (leaving or entering burrows). The 12 ACRSs recorded 5318 instances from 10 Sungazers either leaving or entering their burrows, over a period of ~6 months spanning winter and spring. Two ACRSs that were installed at one burrow cluster, where only two burrows were being monitored, collectively only recorded three instances of lizards either leaving or entering their burrows over the entire study period. In another burrow cluster, one ACRS recorded two instances of lizard activity, while another ACRS in a different cluster only recorded four instances of lizard activity. The remaining eight ACRSs at the burrow clusters recorded an average of  $667 \pm 346$  (Mean  $\pm$  SD) instances of lizards either leaving or entering their burrows.

#### ***2.3.1.1 Time Reporting***

The ACRSs showed a 99.2% success rate in reporting accurate time for lizard activity, with a 0.8% failure rate. Four ACRSs reported instances of lizard activity with inaccurate times (e.g. reporting time as a.m. instead of p.m. and vice versa), each possessing a failure rate of 0.1,

0.3, 0.6 and 4.7%, respectively. Three of the ACRSs that displayed instances of inaccurate time reporting had a success rate > 99%, while one showed a success rate of 95.3%.

#### *2.3.1.2 Date Reporting*

The ACRSs displayed an overall success rate of 99.8% in reporting accurate dates for lizard activity. Only two ACRSs had inconsistencies in reporting the accurate date, with one having a 0.3% failure rate and the other a 0.98% failure rate. Both systems had a success rate of > 99%.

#### *2.3.1.3 Delayed Reporting*

There was an overall success rate of 99.5% in the ACRSs ability to report instances of lizard activity as it occurred. Three ACRSs showed cases of delayed reporting of lizard activity, each displaying a failure rate of 0.1, 2.8, 0.8%, respectively. Two of the three systems possessed a > 99% success rate, while one showed a success rate of 97.2%.

#### **2.3.2 ACRS Field Durability**

In general, the ACRSs maintained structural integrity throughout the duration of the study period. A mid-study check-up on the systems revealed that the antennas from three systems had been removed from the burrows, resulting in less than a week of data loss from those systems. The two systems that only recorded three instances of lizard activity throughout the study period were unable to maintain cellular connectivity. One of those two systems had its reader board broken off from the cellphone engine and thus did not report on lizard activity from the burrow that it was monitoring. Towards the end of the study period (during the last week), both those systems and another two ACRSs had their cellphone engines filled with water after an extreme rainfall event, resulting in these systems failing. However, the remaining eight systems maintained structural integrity and were unaffected by the rainfall event during the last week of the study period.

### **2.4 DISCUSSION**

The ACRSs provided high resolution behavioural data over an extended time period for Sungazers entering and leaving their burrows. Since Sungazers rarely move more than a meter or two away from their burrow entrances (Van Wyk 1992), the ACRSs designed for this study were very effective and provided high resolution activity data from Sungazer

activity patterns, even though there were readers that occasionally recorded inaccurate times or dates. Additionally, delayed reporting of Sungazer activity due to poor connectivity was minimal. As a lizard triggered the reader, the data were stored in the circular buffer within the cellphone engine, and upon being able to connect to the internet, the data were posted to the website and can thus still be considered usable data. The majority of the readers maintained structural integrity and survived the environmental conditions experienced in the Highveld grasslands.

This is the first automated PIT tag reader system that enables completely remote access to data for field-based studies and the system was able to effectively monitor movement patterns and activity patterns of a group-living, terrestrial lizard. Although the ACRSs functioned effectively, some readers did fail towards the end of the study, primarily as a result of a rainfall event and water seeping into the circuitry. Inspection of the cellphone engine containers revealed that the heat-gun glue had melted off at the entry point of cellphone engine that is connected to the reader board. As a result, water had seeped into some of the cellphone engine containers from those points and damaged the circuitries of those cellphone engines. Boarman et al. (1998) also experienced water damage during their study, however, their ARS incurred water damage to the reader coils and thus had to be repaired. My ACRSs experienced no damage to the antennas, as a result of water, suggesting that the antennas used in this study were adequately water-proofed. However, there was water damage to four cellphone engines in this study, thus it is essential that a different form of glue, possibly a silicon-based glue or marine silicon is used to seal of the entry and exit points of both the reader and cellphone engine housing containers. Alternatively, placing a waterproof seal in the sides of both the reader and cellphone engine containers where the wiring enters/exits, would be beneficial and would allow for easier modification or repairs to the system, if required.

The ACRSs performed well considering the low network availability experienced at the study site. However, there were two readers that failed to connect to the internet. The failure of these readers can be attributed to their position in the study site; the burrows were located at the bottom of a slope and as a result the network availability was reduced resulting in the readers failing to connect to the internet to upload the lizard activity around those burrows. Fortunately, the reader that had been separated from the cellphone engine, was one of the two readers that were unable to connect to the internet, thus limiting data loss from an additional

system. Examination revealed that the reader that had been separated from the cellphone engine had been gnawed by a small mammal. Additionally, the antennas from the readers that had been removed from the burrow entrances was a result of the ungulates and other large mammals running over the antennae (during a hunting event conducted during my study period), passing over the wiring along the ground and removing the antennas from the burrows. Fortunately, the antennas were replaced and secured to the burrows the weekend after the hunt occurred, and no other antennas were removed for the duration of the study period.

The ACRSs are most similar to the system designed by Boarman et al. (1998) but differs in that the cellphone engine serves as the data logger and has a built-in temperature and humidity sensor. The advantage of having a cellphone engine is that it enables remote access to data as the data are stored in a secure website. Having remote access to data, via a website, ensures that field-costs are kept to a minimum as the researcher would not need to visit the study site as frequently, to download the data, as one would if they used the traditional systems (as used by Harper & Batzli 1996; Boarman et al. 1998; Kunz, 2001; Schulte et al. 2007). However, testing cellular reception at the study site prior to the commencement of data collection is essential. Unlike Boarman et al.'s (1998) system which had the potential to connect a humidity and temperature sensor, the ACRSs designed in this study had a built in two-in-one sensor. The two-in-one sensor was able to give guidelines as to the air temperature above Sungazer burrows, and rainfall experienced at the study site during any given time and had a temperature range accuracy of within 2 °C and relative humidity accuracy of within 5% (AOSONG 2017). The temperature data from the sensor could be used to assess under what environmental temperatures Sungazers initially emerge from their burrows. Additionally, an analysis of the humidity readings could be used to assess the activity patterns of Sungazers during high rainfall events, which often result in burrow flooding (based on field observations). Having the built-in temperature and humidity sensor completely avoids the need of having an additional system of recording ambient conditions (such as temperature and humidity) the field.

The ACRSs in this study are effective for monitoring the movements of animals past specific points and depending on the study may require minor structural modifications. Although this system was useful for monitoring Sungazers whose burrows only have one entrance/exit, it



did not show directionality. However, through the use of a second antenna and modification to the firmware and software, directionality for future studies on Sungazers or fossorial animals that have one burrow entrance/exit, could be implemented. For fossorial animals that have multiple entry points to their burrows, additional readers could be set up at all burrow entrances, enabling researchers to identify from exactly which burrow entrance an animal exits and returns. The ACRS makes it possible monitor movement patterns under varying environmental conditions and hibernation events, particularly for small mammals and rock-dwelling lizards living in crevices. Additionally, modification of the antenna system could make monitoring snake and other animal movements up trees, and around nesting sites possible. Therefore, through minor modifications to the structure and firmware, the ACRSs designed in this study have the potential to enhance studies on movements of animals past specific points.

Not only are the ACRS effective at monitoring animal activities but they are most effective for low-budget projects. In comparison to Castro-Santos et al.'s (1996) system which costs in the region of \$800, and to Boarman et al.'s (1998) system which costs \$1 250 – \$10 0000, my automated system is considerably more affordable, costing only \$130 – \$175 per reader. Although the above studies, and mine, were designed and modified to suit the habitats of the animals in each study, respectively, all the systems are more affordable than the commercially available systems, with my system dominating the affordability criteria. While many ARSs exist, the ACRS is the first system to use a cellphone engine as a datalogger. This low-cost system enables researchers to have remote access to data when monitoring the movement patterns animals past specific points or within burrows. Even though there were structural difficulties with some of the readers, the system in general has a high success rate in uploading the data to a website. Through various modifications, this system could easily be adapted for studies on other species.

## CHAPTER 3

### Activity Patterns of the Sungazer

---

#### **3.1 INTRODUCTION**

##### ***3.1.1 Activity Patterns***

Animals conduct a range of activities which are influential to their physiology and ecology. Activities not only include locomotor functions but may also include foraging, shuttling, and copulation behaviours, and even stationary activities such as ambush foraging (Huey & Pianka 1981) or basking (e.g. Van Wyk 1992). Activity patterns can be influenced by endogenous (internal circadian clock; Alexander & Brooks 1999) and exogenous factors (environmental stimuli influence activity; Winne & Keck 2004). In reptiles, however, exogenous factors such as wind, humidity, temperature and solar radiation have been known to be highly influential to their activity patterns (Avery, 1978; Nicholson et al. 2005). Additionally, they are largely dependent on environmental conditions and as a result actively regulate their body temperatures ( $T_{bs}$ ) through behavioural mechanisms including postural and orientation adjustments, and shuttling behaviours (e.g. Van Wyk 1992; Stanton-Jones et al. under review).

Reptiles, due to their dependence on environmental conditions, show seasonal variation in their diel activity patterns. For example, studies have found that activity periods during the spring and autumn months are unimodal, where there is a single peak in activity each day, while during the summer months, bimodal activity times are present (two peaks of activity, generally morning and late afternoon peaks; e.g. Foa et al. 1994). The gap in activity between the morning and late afternoon periods can be attributed to the finding that reptiles tend to escape midday heat extremes during the summer months (Van Wyk 1992; Wone & Beauchamp 2003). Behaviours that result in cooling could include sheltering in burrows, rock crevices, or simply resting in shady microhabitats. Conversely, some species tend to remain inactive during the summer months due to temperatures being too extreme, but peaks are observed during the spring months (Broekhoven & Mouton 2015). In contrast, reptiles, in general, have levels of activity, known as brumation, during the winter months, where some individuals remain dormant throughout the winter season (Wone & Beauchamp 2003), although sporadic periods of activity in some species have been noted (Foa et al. 1994). This

activity dormancy in reptiles can be attributed to the lack of favourable environmental temperatures and adequate supply of food during the colder seasons.

Differing activity patterns in syntopic species can result in reduced competition (Kirchhof et al. 2010). However, although there is less competition between species, there is still intra-specific competition amongst individuals. Some species also deal with this through the varied use of habitat amongst age and sex classes (e.g. Eifler et al. 2007). Additionally, since most lizards tend to seek shelter during the midday heat extremes, and conduct frequent shuttling behaviours, such activities are a direct thermoregulatory response but can be considered an indirect predator avoidance strategy when individuals are unaware of nearby predators. In addition, seasonal peaks in activity are also considered to vary due to the presence of predators suggesting that some species are more active in seasons where predators are less active (Broekhoven & Mouton 2015). Thus, variation in activity patterns in different species has numerous physiological and ecological advantages.

Diel activity patterns in lizards is often different between males and females. For example, it has been found in many species that male lizards tend to travel greater distances compared to female lizards (Ruddock 2000; Wone & Beauchamp 2003). However, other studies have found no sex differences in terms of movement patterns in some species but have reported that activity patterns in male and female lizards could be restricted to different regions of a habitat (e.g. Eifler et al. 2007). Additionally, activity patterns may also differ with age classes of lizards. For example, Eifler et al. (2007) reported that the juvenile lizards in their study moved more frequently for longer than did adults. Thus, activity patterns are not considered uniform among sex or age classes, but are also considered to be species-dependent.

It is impossible to monitor all aspects of activity patterns in reptiles, and as a result, studies generally focus on certain components of activity, whereby different methods to assess activity are employed. It should be noted that in recapture studies, the use of passive integrated transponder tags (PITs) has gained momentum in recent years. Previous methods in other studies such as Van Wyk (1992) marked individual lizards using toe and scale clippings. While scale and toe clipping were useful for Van Wyk (1992), it makes it difficult to conclude whether or not the markings are actual markings or if they are instead injuries from other animals or intra-specific combat injuries. However, Van Wyk (1992) overcame this issue by uniquely colour-coding individuals which facilitated assessment on the

behaviours of individuals (Van Wyk 1992). Additionally, by tagging Sungazers with PITs, Ruddock (2000) and McIntyre & Whiting (2012) opened a window for future research on the long-term activity patterns of the species. Thus, with the development of PITs, a useful, long-term marking procedure is favoured overcoming the limitations that toe or scale clippings may have.

### ***3.1.2 Introduction to the species***

The Sungazer (*Smaug giganteus*) has a mean snout-vent length (SVL) of 180 mm making the species the largest member in their family (Cordylidae). Cordylids are endemic to sub-Saharan Africa (Branch 1998). Sungazers, also known as Giant Dragon Lizards, are heavily armoured lizards easily distinguishable from other cordylids by their enlarged, keeled caudal spines along with a pair of elongated occipital spines (Van Wyk 1988). The name, Sungazer, is based on the distinct thermoregulatory behaviour that the lizards exhibit. By erecting their forelimbs and elevating the anterior parts of the body, an anterior body-up posture is exhibited as though the lizards are looking at the sun (Branch 1998; Van Wyk 1992; Stanton-Jones et al. under review).

Sungazers are diurnal and are active from spring to autumn, brumating in their burrows during the winter season (de Waal 1978; van Wyk 1992). Their diet consists of a range of invertebrates, including Coleoptera, Diplopoda, Orthoptera, Hymenoptera, Hemiptera and Lepidoptera (Van Wyk 2000). They are considered extreme ambush foragers as they remain at their burrow entrances relying on prey items to come to them (Jacobsen 1989; van Wyk 2000). Breeding is seasonal and reproduction may only occur every two or three years depending on the availability of resources (Van Wyk 1991). When reproduction occurs, females give birth to up to three young (Van Wyk 1991). Due to the slow reproduction rate, along with the fact that sexual maturity is delayed (sexual maturity is only reached at four years of age), Sungazers fit into the K-selection life history strategy (van Wyk 1992).

Sungazers have retained their listing as 'Vulnerable' as initially reported in the South African Red Data Book (1978). It is without doubt that Sungazers deserve its Threatened status based on prevalence of anthropogenically-driven activities in its range (Van Wyk 1992; Ruddock 2000; Parusnath et al. 2017). They are threatened by habitat destruction, pollution, industrial development and illegal harvesting for the pet and muthi trade (Van Wyk 1992; Parusnath et al. 2017). Such anthropogenically-driven activities have the potential to affect the population

structure and ecology of the species.

### ***3.1.3 Distribution and Habitat***

Sungazers inhabit the Highveld grasslands of South Africa and are endemic to the northern Free State and southern parts of the Mpumalanga provinces. Additionally, previous records have listed Sungazers as occurring in KwaZulu Natal (Van Wyk 1992), however, Armstrong (2011) suggested, based on a survey, that the individuals occurring in the province were not indigenous to the KwaZulu Natal province and were instead individuals that were released into farmland properties. Sungazers occur 1400-1800 m above sea level and their distribution is typically characterised by hot summers with widespread rainstorms and winters that are cold, dry with frequent frost spells at night (Van Wyk 1992). Since Sungazers fall in the summer rainfall region of South Africa, most of the rain season occurs between November and March and the dry, winter periods occur between June and August.

The self-excavated burrows of Sungazers occur on gently sloping *Themeda trianda* grasslands (Bates *et al.* 2014; Parusnath 2014) and are generally deeper than 400 mm and range between 530 mm and 3820 mm in length. (Jacobsen *et al.* 1990; van Wyk 1992). Burrow densities are generally in the region of 4-19 lizards/ha with a mean burrow density of  $6.14 \pm 0.89$  lizards/ha (Parusnath 2014). Furthermore, burrows can easily be identified through their oval entrances, a mid-ridge along the floor as well as the smooth soil that leads outside the burrow. While most burrows are occupied by a single adult lizard, juveniles can often co-occur in an adult's burrow and since many Sungazers can be found in a single burrow, it is likely that there is a complex population structure in the species (Ruddock 2000).

### ***3.1.4 Limitations to Previous Sungazer Research***

The most comprehensive research conducted on Sungazers is by Van Wyk (1992). With a lack of technology at the time, Van Wyk (1992) was still able to report on various activity patterns on the species through the direct observation technique. Activity patterns such as shuttling behaviours and postural and orientation behaviours were also recorded. Sungazer populations were found to exhibit bimodal activity patterns which were more pronounced during the hot summer months and few individuals were active during mid-day heat extremes, with increased shuttling behaviours during this time (Van Wyk 1992). Additionally, Sungazers remained active around their home burrows and only temporarily

moved away from their home burrows for nearby feeding opportunities, to defecate or to engage in copulation (Van Wyk 1992). A later study highlighted the need for research on the social structure of Sungazers (Ruddock 2000). After applying a similar methodology to Van Wyk (1992), Ruddock (2000) monitored the movement patterns of Sungazers from an observation tower using a telescope. The study also concluded that Sungazers exhibited high site fidelity and showed restricted dispersal patterns across seasons (Ruddock 2000). It was also concluded that Sungazers have a social system that is site defensive and well suited to their K-selection life history (Ruddock 2000).

Both Van Wyk (1992) and Ruddock (2000) had limitations: Sungazers were observed from an observation tower with either binoculars or a telescope; this has obvious logistical limitations such as the difficulty of monitoring multiple lizards simultaneously, where abnormal behaviours may be missed, and extensive periods spent in the field observing the lizards becomes costly. Another limitation to Van Wyk's (1992) study was that conducting only two scans per hour across ~20 burrows could result in shuttling behaviours being missed and the reported results misrepresented. Both studies have highlighted the need for further research on the species. What remains unknown is the proportion of time that Sungazers spend active above their burrows during winter, along with how frequently shuttling behaviours are conducted and what activity patterns are like during the colder winter months of the year. Technological advances have made it possible to monitor such activity and have the ability to provide high resolution data.

In this chapter, I used recently developed technology, the Automated Cellular Reader System (ACRS), to measure the activity and movement patterns of free-ranging Sungazers, and specifically to test the hypothesis that Sungazers are active during winter, even though activity patterns during this time are different to those during spring. The findings contribute to the biology of the species during a season which was previously poorly sampled. I assessed movement between burrows, shuttling behaviours, and the proportion of time that Sungazers are active above ground during the winter and spring seasons.

## **3.2 METHODS**

### ***3.2.1 Study site***

Sungazers were studied on a privately-owned farm near the town Heilbron in the Free State

Province, South Africa. The farm is used for game farming and supports a variety of species of indigenous ungulates, game birds and rodents, but lacks large predators. A yearly Guinea fowl (*Numida meleagris*) hunt is conducted in August. However, the lack of conventional agricultural activities proves an ideal, natural setting to monitor the activity patterns of Sungazers. Data were collected over the winter and spring seasons (June 2017-November 2017), seasons during which little was previously known about the behaviour of the species.

### ***3.2.2 Experimental design and protocol***

#### ***3.2.2.1 Sungazer Capture and Release***

I implanted PITs into 58 Sungazers across the study site. I monitored 12 burrows using the ACRSs resulting in activity records for 10 lizards. Lizards were captured and marked during January 2016, January 2017 and February 2017, using noose traps consisting of an iron nail with two string nooses that were placed at the burrow entrances. Traps were deployed and monitored at 10-minute intervals to ensure that captured lizards did not remain in traps for extended periods. Upon catching a lizard, the traps were redeployed. Captured lizards were scanned for a passive integrated transponder tag (PIT) using the EasyTracer FDX/HDX handheld Reader, to check if it was a recapture. The site for injection and the needle and PIT were cleaned thoroughly using F10 disinfectant. PITs were injected subcutaneously into the dorso-lateral surface of the body of captured lizards, and the open wound was cleaned again and F10 disinfectant cream was topically applied. Marked lizards were then scanned and the unique ID of the PITs were recorded, along with the GPS coordinates (accurate to within  $\pm 5$  m; Garmin GPSmap 78 s; datum WGS1984) of the burrows of the captured lizards.

Additionally, morphometric measures, including snout-vent length (SVL), mass, and tail length were recorded, along with sex (males have generation glands on the dorsal surface of the fore- and hind-limbs) and age (broadly as adult/sub-adult/juvenile/neonate). Captured lizards were released to their home burrows, following the processing protocol.

#### ***3.2.2.2 Reader Deployment***

Automated Cellular Reader Systems (ACRS) were deployed at 12 Sungazer burrows, respectively. The 12 burrows were split into two clusters of three, one cluster of four and one cluster of two, whereby each cluster was selected based on the proximity of burrows to the main power supply source. Within each cluster, a single ACRS was placed at each burrow, and all the ACRSs joined to a main power supply unit which was central to all burrows within a cluster, and consisted of a Bosch 100 Ah battery, a 50 W solar panel (SP-FG-50W)

and a 10 A solar charge controller (ECCO; see Chapter 2). Deployment of the readers were as follows: the copper loop antenna of the ACRS was secured and shaped to the entrance of the Sungazer burrow, and the reader circuitry, concealed in a water tight plastic container, along with the attached cellphone engine (in a similar water tight plastic box) were placed on the ground above the burrows, and behind the entrance of the burrows between in the long grass as to limit any possible stress to the individual lizards. The connecting leads were then connected to the output connection of the power supply. Following the deployment of an ACRS, the system was programmed to the burrow number using an SMS-based system (see Chapter 2). In addition, data and airtime were loaded monthly onto each SIM card. The readers were all deployed and programmed on the 9<sup>th</sup> of June 2017 and data collection from the readers terminated on the 30<sup>th</sup> of November 2017.

### **3.2.3 Data Analysis**

#### **3.2.3.1 Data Processing**

The data that were collected by the ACRSs were stored on a secure website database. These data were exported to Microsoft Excel (Microsoft Office 365), for further processing. Each day during the study period, the number of times the marked lizards emerged from their burrows was counted. Each time that a marked lizard came out and returned to its burrow was recorded as an emergence-retreating event. Since the readers did not directly record directionality, the first instance that the reader recorded a lizard, with its unique ID (from the PIT), was taken as a lizard exiting their burrow, the following record for the same lizard was taken as the lizard re-entering its burrow, generating a paired movement (emergence-retreating event) for each lizard with a unique ID. Occasionally, the reader recorded several instances of a marked lizard over consecutive minutes and this was interpreted as a lizard being active at their burrow entrance. Each day, the time of the first record of each marked lizard exiting their burrow and the last record of each marked lizard re-entering their burrow was recorded, and the duration was calculated. This duration was defined as the duration of daily activity – the time that each marked lizard could have been active above ground on a given day. The duration between an emergence-retreating event of each marked lizard being active above ground was calculated and a calculation of the total time that each marked lizard was above ground for the day was made. With this, the proportion of the duration of daily activity that was spent above ground was calculated using the following formula:



$$\text{Proportion of duration of daily activity above ground} = \frac{\text{Total Time above ground}}{\text{Duration of daily activity}} \times 100.$$

Averages of each category (burrow fidelity and lizard movement, shuttling behaviour, time activity – see following subsections) for each marked lizard, as well as seasonal and sex averages were calculated. All data were tested for normality and because the data for proportion of the duration of daily activity of the marked lizards that were active were not normal (Shapiro-Wilk normality test;  $P < 0.05$ ), the data were transformed using the Logit transformation function in Microsoft Excel. All normality testing and statistical analyses were conducted in IBM SPSS Statistics (Version 23). From here on, I will refer to all marked lizards as ‘lizards’.

#### *3.2.3.2 Burrow Fidelity and Lizard Movements*

To assess burrow fidelity, I quantified the number of lizards that moved from one burrow to another or temporally visited another burrow. A chi-squared test was used to compare differences between sexes. I also calculated the frequency of lizards that moved to neighbouring burrows and recorded the frequency of visits to neighbouring burrows. Additionally, for the lizards that moved or visited neighbours, the distances to the visited or new burrows were calculated using Google Earth Pro (Version 7.3.1.4505), and the average distances that the lizards moved were calculated using Microsoft Excel.

#### *3.2.3.3 Shuttling Behaviour Assessment*

I calculated the average frequency of shuttling events per lizard per day and compared the results between winter and spring using a paired t-test. I used a two-way analysis of variance (ANOVA) to compare differences between sex and seasons. The average durations of emergence-retreating events were also calculated and comparisons between seasons were conducted using a paired t-test and a comparison between sex and season was conducted using a two-way ANOVA.

#### *3.2.3.4 Time Activity Assessment*

The proportion of days that Sungazers were above ground during winter and spring were calculated. A chi-square test was used to compare the differences in the proportion of days active and days not active between seasons. The average range of time that Sungazers could

be active above their burrows (duration of daily activity) was calculate along with the average total time that each lizard actually spent above ground each day, and paired t-tests were conducted, respectively, to compare differences between seasons. A two-way ANOVA was also used to compare the total time that lizards were active above ground between sex and seasons. Additionally, the proportion of the duration of daily activity that lizards were active above ground was also calculated and an average per lizard, per season was calculated. Seasonal differences for all the lizards were compared using a paired t-test while differences between sex and season were tested using a two-way ANOVA.

### **3.3 RESULTS**

Data from 10 lizards (5♂; 5♀) were collected from the 12 ACRSs. Two ACRSs experienced poor network connectivity and as a result did not collect data from the lizards in those burrows (Chapter 2). Collectively, the readers recorded 5318 instances of lizards either exiting or retreating down their burrows.

#### ***3.3.1 Burrow Fidelity, Burrow Swapping and Movement Patterns***

Sungazers show high burrow fidelity, with the majority of the lizards remaining active around a particular burrow, the burrow at which they were captured. However, three individuals, two males and one female, that were caught and tagged in 2016, the year before the deployment of the readers, which occupied a different burrow from the burrows that they were initially caught and tagged from in 2016, and remained in their newly-occupied burrows for the duration of the ACRSs data-collection period (June-November 2017). Males showed significantly more movements ( $X^2 = 8.6$ ,  $P < 0.05$ ) between different burrows, at an average ( $\pm$  SD) travel distance of  $21.6 \pm 6.0$  m between burrows (Table 1), than females, with two males permanently occupying different burrows to their burrows of capture and the remaining three males displayed frequent visits to neighbouring burrows, always returning to their home burrow after a visit, which was consistently less than a day. One female permanently moved to the second nearest burrow (16 m from burrow of capture) and remained active around that burrow, while the remaining four females did not move to or visit other burrows. One male visited the same female seven times during the study period (June-November 2017), which occupied the second nearest burrow to the male. The other two males made frequent visits to each other, with the one male visiting the other 18 times throughout the study period (Table 1). There were no records of burrow swapping during the

study.

**Table 1:** The distances that Sungazers moved during a visit or permanent move.

| Sex               | Distance Moved (m) | Number of Visits | Note           |
|-------------------|--------------------|------------------|----------------|
| Male              | 12.91              | 2                | Male visit     |
| Male              | 34.63              | 1                | Permanent move |
| Male              | 25.04              | 1                | Permanent move |
| Male              | 12.91              | 18               | Male visit     |
| Male              | 12.69              | 7                | Female visit   |
| <b>Mean ± SD:</b> |                    | 21.6 ± 6.0       |                |
| Female            | 15.58              | 1                | Permanent Move |
| Female            | 0                  | 0                |                |
| Female            | 0                  | 0                |                |
| Female            | 0                  | 0                |                |
| Female            | 0                  | 0                |                |
| <b>Mean ± SD:</b> |                    | 3.1 ± 7.0        |                |

### 3.3.2 Shuttling Behaviour

Sungazers shuttled above and below ground significantly more frequently per day during spring ( $\bar{x} = 4.8 \pm 1.9$  (SD) shuttles/day), compared to winter ( $\bar{x} = 2.0 \pm 1.8$  (SD) shuttles/day; t-test,  $t = -6.0$ ,  $P < 0.001$ ; Figure 3.1a). There were no significant differences in shuttling behaviour in relation to sex ( $F_{1,16} = 0.01$ ,  $P = 0.9$ ; Figure 3.1b), nor for the interaction of sex and season ( $F_{1,16} = 0.5$ ,  $P = 0.7$ ; Figure 3.1b). In addition, there is a trend for Sungazers to be above ground for a longer duration between an emergence-retreating event per day during spring ( $\bar{x} = 50.3 \pm 24.1$  (SD) min) compared to winter ( $\bar{x} = 26.5 \pm 26.3$  (SD) min), although the results were not statistically significant (t-test,  $t = 2.0$ ,  $P = 0.08$ ; Figure 3.2a). There were also no significant differences between sex ( $F_{1,16} = 1.2$ ,  $P = 0.3$ ) and the interaction of sex and season ( $F_{1,16} = 0.4$ ,  $P = 0.5$ ) for the average duration of an emergence-retreating event of Sungazers above ground (Figure 3.2b).

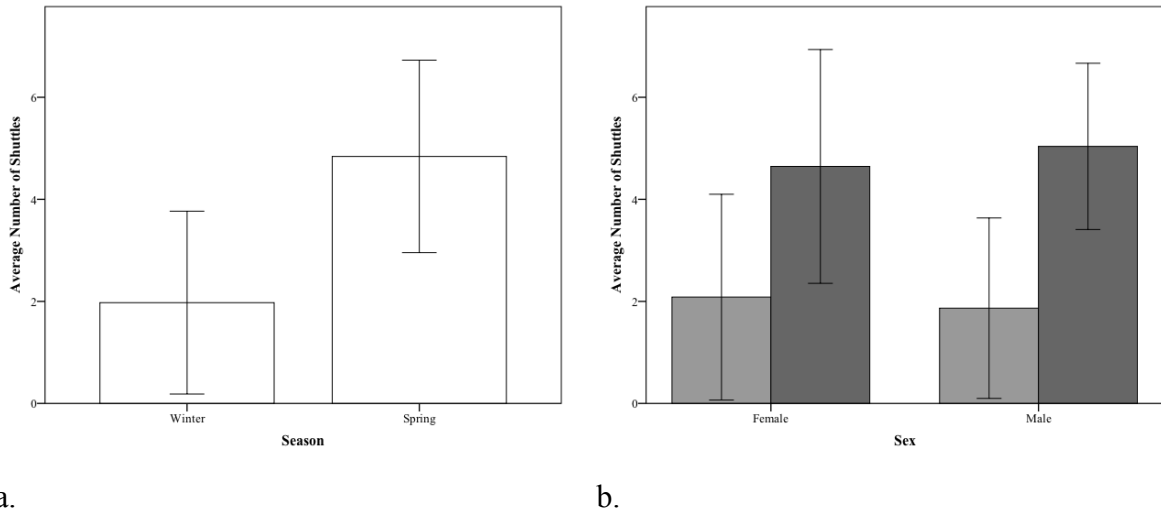

**Figure 3.1:** The average number of shuttles that Sungazers performed per day across two seasons (a) and the difference in shuttling behaviours between sex across two seasons (b). Data are representative of  $\bar{x} \pm SD$ ,  $N = 10$  ( $5\sigma$ ;  $5\phi$ ). Dark grey bars and light grey bars are representative of spring and winter, respectively (b).

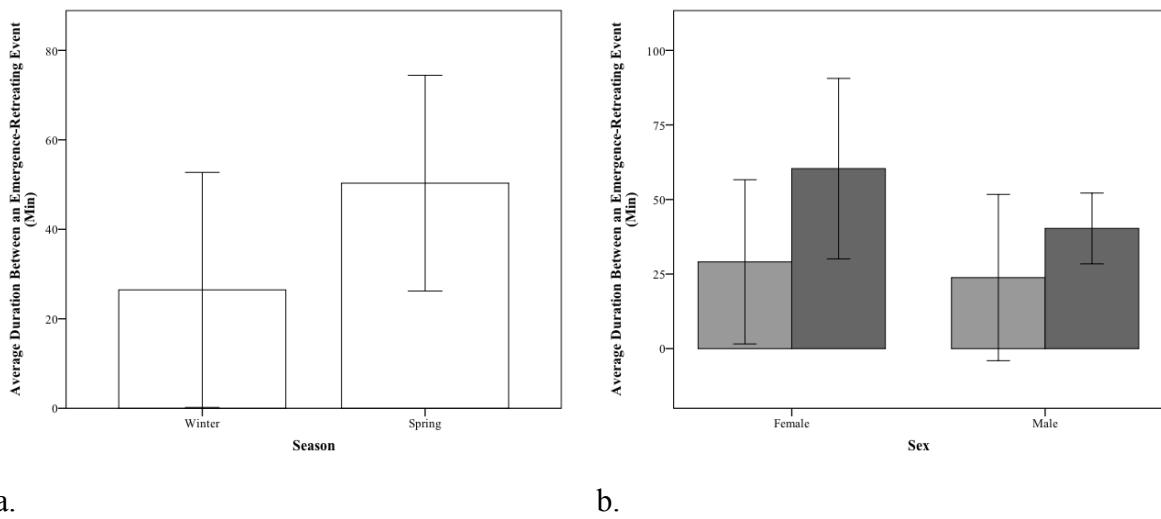

**Figure 3.2:** The average duration between an emergence-retreating event per day per lizard between seasons (a) and the average duration between an emergence and retreat event between sex and seasons (b). Data are representative of  $\bar{x} \pm SD$ ,  $N = 10$  ( $5\sigma$ ;  $5\phi$ ). Dark grey bars and light grey bars are representative of spring and winter, respectively (b).

There were two instances where Sungazers showed abnormal behaviour during October 2017. The first Sungazer, a female, was recorded at the entrance of her burrow on the 3<sup>rd</sup> of October 2017 at around midnight (00h00), where the readers recorded a humidity of 73% and environmental temperature of 12 °C; she immediately retreated following the

emergence. A male Sungazer was found performing similar behaviour but on the 7<sup>th</sup> of October 2017, also at midnight, when humidity was recorded as 50% and environmental temperature was 12 °C at the time of emergence. The male retreated a minute later.

### 3.3.3 Time Spent Active

Sungazers were active above ground for significantly more days during spring compared to winter ( $\chi^2 = 48.1$ ,  $P < 0.001$ ). During the winter months, only six lizards emerged from their burrows, and the activities of at least a single lizard being above ground covered 37.3% of the days of the winter months that the ACRSs were collecting data. In contrast, all 10 Sungazers emerged from their burrows over 87.9% of the days of spring (Table 2). During winter, Sungazers would emerge from their burrows as early as 08h00, when environmental temperatures were as low as 2 °C, but on occasion would retreat for the last time for the day as late as 17h15. However, during spring, Sungazers would emerge as early as 05h25 and a last retreat would occur as late as 18h50.

**Table 2:** The total number of days that Sungazers were active each season. The data reported are cumulative frequencies of all Sungazers during each season.

| Season        | Number of Days Active | Number of Days Not Active | Percentage Active (%) | Percentage not Active (%) |
|---------------|-----------------------|---------------------------|-----------------------|---------------------------|
| Winter        | 31                    | 52                        | 37.3                  | 62.7                      |
| Spring        | 80                    | 11                        | 87.9                  | 12.1                      |
| <b>Total:</b> | 111                   | 63                        | 63.8                  | 36.2                      |

The duration of daily activity differed significantly between seasons (t-test,  $t = -7.7$ ,  $P < 0.001$ ). Sungazers in winter averaged  $101 \pm 95$  min/day ( $\bar{x} \pm SD$ ) and  $331 \pm 112$  min/day ( $\bar{x} \pm SD$ ) in spring. Similarly, Sungazers were active for  $70 \pm 64$  min/day ( $\bar{x} \pm SD$ ) during winter, which was significantly lower than the  $178 \pm 55$  min/day ( $\bar{x} \pm SD$ ) that they were active during spring (t-test,  $t = -7.5$ ,  $P < 0.001$ ; Figure 3.3a). However, no differences were found between males and females ( $F_{1,16} = 1.7$ ,  $P = 0.2$ ), nor in the interaction of sex and season ( $F_{1,16} = 0.1$ ,  $P = 0.8$ ; Figure 3.3b). In addition, Sungazers spent a similar proportion of the duration of daily activity above ground during each season (t-test,  $t = 1.0$ ,  $P = 0.3$ , Figure 3.4a). However, the variation (in terms of standard deviation) was greater in winter

compared to spring (Figure 3.4a). Similarly, male and female Sungazers were active for a similar proportion of the duration of daily activity ( $F_{1,16} = 0.01, P = 0.9$ ), but the variation in the proportion of the daily activity that females were active per day was higher compared to males, during both seasons (Figure 3.4b).

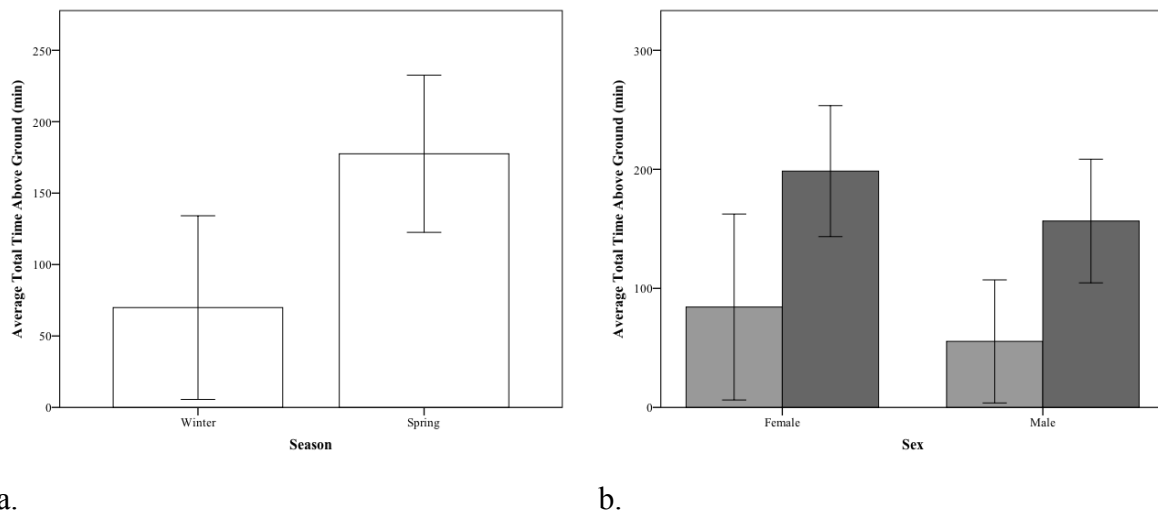

**Figure 3.3:** The average total time that Sungazers were above ground per day per season (a), and the comparison between sex (b). Data are representative of  $\bar{x} \pm SD$ ,  $N = 10$  ( $5\♂$ ;  $5\♀$ ). Dark grey bars and light grey bars are representative of spring and winter, respectively (b).

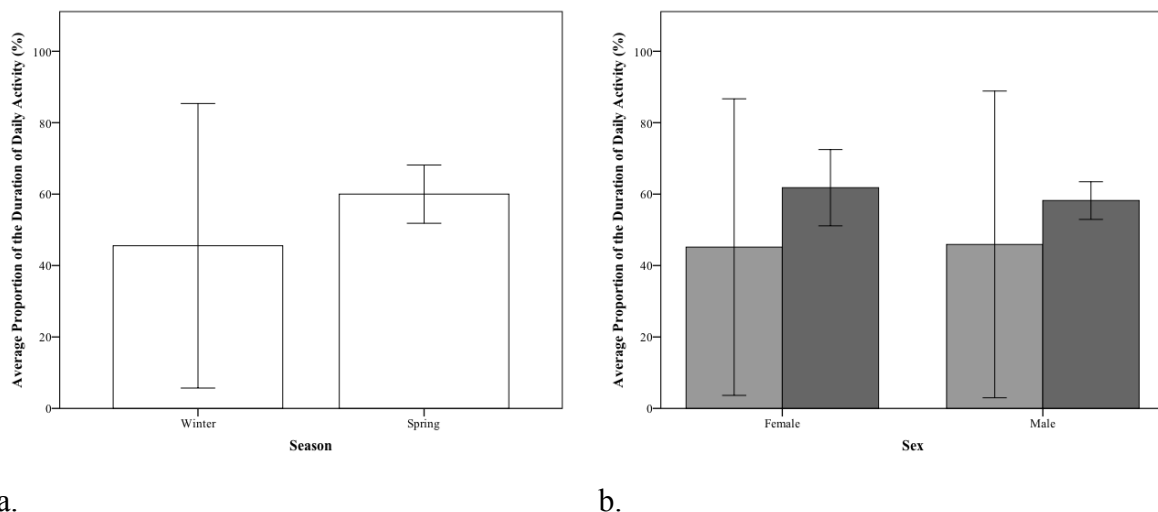

**Figure 3.4:** The average proportion of the duration of daily activity that Sungazers were active above ground between seasons (a), and the differences between sex (b). Data are representative of  $\bar{x} \pm SD$ ,  $N = 10$  ( $5\♂$ ;  $5\♀$ ). Dark grey bars and light grey bars are representative of spring and winter, respectively (b).

### **3.4 DISCUSSION**

Sungazers show high burrow fidelity in which no seasonal variation occurs, but movements to nearby burrows are more frequent in males than females. Although Sungazers generally enter brumation during the winter period, the results in the present study confirmed my hypothesis that at least some individuals are occasionally active during this time, and overall, the activity patterns of Sungazers differs between winter and spring. Sungazers spend less time above ground during the winter season, but the proportion of the duration of daily activity when they are active above ground is similar between winter and spring. In addition, due to the warmer environmental temperatures experienced during spring, Sungazers shuttle more frequent in and out of their burrows. Collectively, the results of this study suggest that seasonal variation exists in the activity patterns of Sungazers.

This is the first study to make use of a completely automated bio-logging system that uses PITs to monitor activity patterns, and that enables remotely accessible data. Although the ACRSs were effective tools for monitoring Sungazer activity, they did fail on occasion, primarily due to water seeping into the containers housing the circuitries, and two readers recorded few data points as a result poor network reception due to their position in the landscape (see Chapter 2). It is therefore recommended that network reception be tested across all areas of the landscape where the study is to occur, and that a backup data-storage component is built into the ACRSs as to ensure that data are not lost. Additionally, although the housing containers were considered to be watertight, any additional holes placed in the containers to thread the wires, need to be properly sealed to ensure water does not seep in (Boarman et al. 1992). Despite the failure of two readers, the addition of a cellphone engine as the data logger in the reader system, enabled me to access the data remotely on any electronic device that had an internet connection. The development of the ACRSs meant that this study would be the first to report high resolution data on the activity patterns of Sungazers across seasons, but more specifically activity patterns during winter – a season that has been neglected in the literature pertaining to Sungazers.

Site fidelity and movement patterns appears to be different between sexes of Sungazers, and other studies have reported similar findings in other species. Eifler et al. (2007) reported that graceful crag lizards (*Pseudocordylus capensis*) did not show differences in movement between males and females, but did reported that male movements were restricted to high

peaks on rocks and female movements to the middle region of the rocks. Another study reported differences in the distances travelled between male and female horned lizards (*Phrynosoma mcalli*) and found that males would travel further distances than females (Wone and Beauchamp 2003), which is the opposite finding to Eifler et al. (2007) but similar to the findings in my study on Sungazers and to Ruddock (2000). Additionally, the increased movements recorded in male Sungazers can be attributed to the breeding season in the species as Van Wyk (1992) reported that autumn and/or spring is the breeding season of Sungazers, so it is not surprising that males temporarily left their home burrows to seek out females. Burrows occupied by female Sungazers may be situated further apart from the burrows occupied by male Sungazers, which is likely the reason why male Sungazers travelled further distances than females.

The finding that male Sungazer moved between burrows more often than did females was also reported by Ruddock (2000). In addition, Ruddock (2000) reported that male Sungazers occupied more burrows compared to females, which supports my findings. Ruddock (2000) also found that ~65% of the females in the study moved between burrows, which is different to the results of the present study whereby only a single female lizard had changed burrows but remained active at that burrow for the duration of both seasons, but still concluded that males moved more frequently than did females. It has also been shown that Sungazers generally remain active at the entrance of their burrows unless a nearby foraging opportunity arises or if they engage in mating (Van Wyk 1992; Ruddock 2000). Thus, even though movements between burrows occurs, movements tend to be short, and Sungazers generally return to their home burrows.

Environmental factors such as temperature and humidity have significant impacts on the activity patterns of ectothermic animals. It is not surprising that Sungazers are more active during spring compared to winter, when environmental temperatures are higher, which is a similar finding to other studies (e.g. Avery 1978; Ellinger et al. 2001). However, although higher environmental temperatures result in an increase in activity, additional abiotic factors, such as wind and cloud cover could potentially reduce above-ground activity (Avery 1978; Ellinger et al. 2001), forcing Sungazers to remain within their burrows or to retreat again shortly after emerging from their burrows (Van Wyk 1992). Additionally, it has been shown that Sungazers are likely to emerge from their burrows when deep burrow temperatures are exceeded by entrance and mid-burrow temperature, which is generally earlier during the



summer months (Van Wyk 1992). Although, factors such as light or an endogenous rhythm could also contribute to Sungazers emerging from their burrows (Van Wyk 1992). It should, however, be noted that increased activity under higher environmental temperatures is not standard across lizards and other reptiles, as Nicholson et al. (2005) reported that no differences occurred in the activity patterns of adult *Anolis stratulus* under changing environmental temperatures. Additionally, the study found that juvenile *Anolis* were more active under colder environmental temperatures (Nicholson et al. 2005). Nicholson et al. (2005) also reported that lizards were more active under high humidity. The increased activity during more humid conditions can be attributed to small body size of both species, as a smaller body size makes individuals more vulnerable to water loss (Nicholson et al. 2005). However, in the case of the Sungazers, who are comparatively larger lizards, water loss because of body size is unlikely, and high rainfall occurs during the warmer seasons of the year (Van Wyk 1992).

Sungazers tend to show bimodal activity patterns during spring. Generally, Sungazers emerged from their burrows at sunrise, remained active around burrow entrances, conducted numerous shuttles in and out of burrows and would finally retreat for the day at sunset, which is a similar finding to Van Wyk (1992). However, during the midday hours (hottest part of the day), a small proportion of Sungazers observed by Van Wyk (1992), were active and displayed increased shuttling behaviours over this time, suggesting that there is some variation in activity patterns. The finding that Sungazers spend a small proportion of their time active above ground during the midday hours is also supported by Stanton-Jones et al. (under review). By comparison, the winter dataset suggests that the small number of Sungazers that were active exhibited unimodal activity patterns, which is a similar find to their activity during the colder days of autumn (Van Wyk 1992). Although, the increased variation in the proportion of the duration of daily activity during winter can be attributed to the fact that there were occasionally warm days. However, it is still unclear as to why some individuals emerged from their burrows on cold winter days. Such behaviour has the potential to be linked to an immune response, meaning that individuals emerge from their burrows in an attempt to bask to raise  $T_b$  (behavioural fever) in response to infection (Rakus et al. 2017). Such studies on reptiles remain understudied, however are of growing interest (e.g. Ryan et al. 2018). Alternatively, however, the change in environmental conditions from summer to autumn and then to winter could possibly trigger reproduction in the species, as Van Wyk (1992) reported that vitellogenesis in breeding females begins during autumn and is

maintained throughout winter, peaking at the end of winter. Although, this suggestion remains speculative and further research is required to conclusively prove the hypothesis.

It is without doubt that the behaviours of field-active Sungazers is dependent on environmental conditions, but it is likely that captive individuals show different behavioural trends. There has been an increasing concern for the species survival since they are sought after in the pet trade (Parusnath et al. 2017). In addition, breeding Sungazers in captivity has largely been ineffective, but notes on their activity in captivity have been recorded (Fogel 2000). The patterns of activity that I recorded in male Sungazers in this study are similar to those measured in captive Sungazers (Fogel 2000). What differs, however, is that females in captivity tend to visit burrows occupied by male Sungazers, which contradicts the findings in this study (Fogel 2000). It is likely that in captivity, Sungazers do not have a choice of where to construct burrows thus movements or visits to burrows is restricted to within the enclosure, and if a female burrow is strategically built near the male burrow, she will investigate that burrow, given an opportunity. However, it is possible that this observed behavioural response in females could be linked pheromonal secretion by male Sungazers but this is speculative, given the current lack of research in the field of pheromonal communication in the species.

My study provides an informative comparison of activity patterns exhibited by Sungazers during the winter and spring seasons, periods where Sungazer activity has received the least attention, especially during the winter season. Although Van Wyk (1992) measured the activity of Sungazers across different seasons, the results of this study have already shown that the use of a passive system whereby continuous monitoring occurs, allows data to be collected during periods where no activity is expected. Thus, it would be worthwhile to assess activity patterns of the species during summer and autumn, using the ACRSs such that an extensive comparison on seasonal variation can be made, and compared to the results on seasonal activity whereby the direct observational method is used (Van Wyk 1992). It is reasonable to expect that just like the data collected in this study, the ACRSs will collect high resolution data on activity patterns during the summer season, providing an opportunity to conduct a detailed analysis on shuttling behaviour, in which it is expected that more shuttles would occur during the summer months, especially over the midday hours when environmental temperatures are at their peak. Additionally, as environmental temperatures become colder, autumn is likely to result in a transition of increased activity to decreased activity, and is likely to trigger the onset of vitellogenesis (Van Wyk 1992). Since this study

occurred on a farm that was free from conventional farming practices, analyzing activity patterns of individuals inhabiting farmlands where conventional farming practices occur, and in locations where other anthropogenically-driven activities (e.g. mining) occur would be another worthwhile comparison. With respect to movement patterns, assessing long-term movement patterns of Sungazers would provide valuable information regarding population change and structure.

My study has shown how effective the ACRS is for recording high resolution data on the activity patterns of Sungazers. While Sungazers only display sex differences in terms of movement patterns, there appears to be no differences in sex within the aspects of activity patterns reported in this study, but a larger sample of male and female lizards is needed to conclusively prove no differences in the activity patterns of male and female Sungazers. Additionally, there is enough evidence to suggest that, for reasons yet to be studied, only a few Sungazers spend a small proportion of the day active during winter, supporting my initial hypothesis. Additionally, Sungazers show seasonal variation in activity patterns which is likely to change with respect to land cover change due to anthropogenically-driven activities.

## CHAPTER 4

### General Discussion and Conclusion

---

#### **4.1 GENERAL OVERVIEW**

The purpose of this study was to develop a new automated PIT tag tracking system to enable me to remotely assess data collected in a field setting and to use the device to study free-ranging Sungazers. The addition of the cellphone engine to the reader system effectively served as the datalogger, and a continuous internet connection meant that data were posted to a secure website in real time, allowing for the access of data anywhere, anytime. The automated cellular reader system (ACRS) builds on the system designed by Boarman et al. (1998), and differs not only because of the inclusion of an internet-based datalogger, and temperature and humidity sensor, but in that it has been structurally modified for the use on Sungazer burrows. The ACRSs were highly effective in their ability to accurately report on the activity of Sungazers. Due to the warmer temperatures experienced during spring, Sungazers were more active. However, an important finding was that only a few Sungazers emerged from their burrows during the winter season, while others remained in their burrows, brumating, for the duration of winter. This finding could be linked to the reproductive cycle in female Sungazers in which vitellogenesis is maintained throughout winter (Van Wyk 1992), but could also suggest a behavioural response from Sungazers, in which some of the lizards are attempting to achieve their target body temperature ( $T_{\text{target}}$ ) in a response similar to behavioural fever whereby the animal raises their  $T_{\text{target}}$  if they require a heightened immune response (Rakus et al. 2017). However, this phenomenon has not been extensively investigated in reptiles, but is of growing interest (e.g. Ryan et al. 2018).

While the traditional methods of direct observations for monitoring animal activities are effective, they suffer several limitations. As a result, the growth of technology over the past few decades have resulted in studies reporting on more accurate, meaningful findings. There are various methods of tracking systems that have each, in their own way, been modified to suit the requirements of a specific study on animals. With respect to the direct observational methods, the inclusion of video cameras has led to findings on previously unrecorded behaviours (e.g. Glaudas & Alexander 2017). In capture-mark-recapture (CMR) techniques, clippings of scales and toes are avoided through the development of other tags such as PITs and microwires (Sharp et al. 2000), despite the physiological and behavioural implications

that may result. These technological developments along with radiotelemetry, satellite transmitters, geolocators and bioacoustic monitoring technologies, have resulted in researchers being able to answer previously intractable questions relating to an animals physiology and ecology, especially with regard to movement patterns, habitat use, population structure and turnover, and activity patterns.

One of the most useful tagging systems has been from the implementation of RFID technology, especially whereby PITs are used. Having been used extensively in ichthyological studies (Prentice & Park 1983, Prentice et al. 1990, Roussel et al. 2000, Cooke et al. 2013, Weber et al. 2016), PITs have proven to be a successful method of permanently tagging individuals. The result is that researchers are able to monitor population change, habitat use and movements past specific points. PITs have since been used to tag small mammals (Kunz 2001), amphibians (Schulte et al. 2007) and reptiles (Boarman et al. 1998, Ruddock 2000, McIntyre & Whiting 2012, present study). The development of autonomous reader systems (ARS) has reduced the need for the traditional handheld readers. However, although most ARSs collect data remotely, they still require a researcher to actively download the stored data on regular occasions depending on the storage capacity of the datalogger. This in turn incurs additional costs associated with the extra travelling to those field sites. Additionally, commercially available ARSs can be costly. The development of the ARS in this study overcomes those prior issues, especially with regard to remote access to data. I also included a temperature and humidity sensor, into the ARSs with the future purpose of monitoring above-ground environmental conditions experienced during Sungazer activity. Of course, like previously modified systems, my ARS can be easily modified and adapted to suite other studies.

The ACRSs developed for this study proved to work efficiently on Sungazers since Sungazers have high site fidelity, are ambush foragers and rarely move far from their home burrows (Van Wyk 1992, Ruddock 2000). In addition, the results of the study provides support for the use of ACRSs in studies where researchers monitor movements past specific points. This coincides with the use of the ARS developed by Harper & Batzli (1996) who employed it to track the movements of voles within highways. Boarman et al. (1998) provides additional support for tracking animal movements past specific points, through the development an autonomous system to track the movements of desert tortoises through culverts under highways. Since many individuals are killed along highways, runways or even

by other anthropogenically-driven activities, the use of ARSs and findings from each of the above studies provides important information for the conservation strategies for animals.

My study has provided useful information regarding the activity patterns of Sungazers. More specifically, I found that Sungazers displayed seasonal variation in their activity patterns which aligns to most studies on activity patterns in reptiles (e.g. Van Wyk 1992; Foa et al. 1994, Zamora-Camacho et al. 2013). Due to the changes in temperature and humidity, it is not surprising that Sungazers are more active during the spring and less active during winter. In some cases, certain species favour more humid environments so as to prevent water loss, presumably because of a small body size (Nicholson et al. 2005). However, in the case of the Sungazer, which is the largest lizard species within the Cordylidae, being active under more humid conditions is unlikely to align with the finding by Nicholson et al. (2005). With a lack of a nearby water source near burrows, Sungazers would do not generally have access to free water and must therefore remain in water balance by using water in their food, or through the occasional drinking of rain water or early morning dew. Since humid conditions are likely to reduce water loss, activity bouts during higher humidity would help maintain water balance. Additionally, although not reported in my study, I have observed an increased activity of Sungazers after a rainfall event, presumably as to benefit from the water supply and foraging opportunities that arise after rainfall. It is also worthwhile noting, that Sungazers are occasionally forced to the entrance of their burrows during an intense rainfall event, as a result of burrows flooding which may take several days to drain. However, this is a separate study in itself in which the implications of high rainfall on Sungazer activity could be assessed. Now, with the development of the ACRSs, such a study would certainly be possible.

Environmental temperature and solar radiation is a major contributing abiotic factor to the activity of ectothermic animals such as reptiles (Avery 1978; Nicholson et al. 2005). Typically, reptiles regulate their body temperature over a wide thermal range in which they attain a target temperature to ensure optimal functioning of physiological functions (Alexander 2007, Stanton-Jones et al. under review). Sungazers achieve this by spending a large portion of their time active above ground, employing different postures and orientations to achieve this target temperature (Stanton-Jones et al. under review). It is therefore expected that Sungazers spend proportionally more days active above ground during spring compared to winter. Additionally, due to the higher temperatures experienced during spring, the finding

of increased shuttling behaviours was expected. However, the Sungazers that were active above ground during winter not only showed reduced shuttling behaviours, but also displayed large variation in the proportion of the duration of daily activity when they were actually above ground. On warmer winter days, it is plausible that Sungazers would be active for proportionally more time compared to colder winter days. Although, the contrasting finding was that only few individuals emerged from their burrows during winter. This aligns with the hypothesis that active individuals are motivated by the need for a more effective immune system (Rakus et al. 2017). Nevertheless, this study has provided the first evidence for Sungazer activity during the winter season.

#### **4.2 LIMITATIONS AND RECOMMENDATIONS**

As with all scientific studies, there were limitations to the present study. While the ACRSs were effective in the field, they occasionally did fail (Chapters 2 and 3). Firstly, towards the end of the data collection period, a high rainfall was experienced at the study site. As a result, water had seeped into the housing containers of the RFID and cellphone engine circuitries. Closer inspection revealed that the glue used to seal off the wiring entry/exit terminals of the housing containers were unable to withstand the temperature extremes during the latter part of spring. The melting of the glue resulted in water seeping into the housing containers. Thus, it is recommended that an alternative adhesive, perhaps silicon based, be used to seal off the wiring entry/exit terminals. In addition, two readers displayed poor network reception. Unfortunately, this resulted in a loss of data from the lizards occupying those particular marked burrows. However, because this study presented the first field test of the ACRSs, such failures were expected, and such failures can easily be corrected by replacing the current antenna of the cellphone engine with a larger one. Alternatively, pre-emptively testing the network reception at the study site would highlight such limitations. As a backup, I would recommend installing a data-storage component into the ACRSs as to ensure that under poor network availability, data are still collected and stored. Vodacom served as the network provider in this study, purely because they offered the best range of network for the study site. The implication of this, however, was that because the data expired after a month, the study became more costly. Finally, because the habitat was not occupied by only Sungazers, the additional wildlife does occasionally disrupt the setup of the systems which cannot easily be controlled.

### **4.3 FUTURE WORK**

The development of the ACRSs are without a doubt, an important breakthrough in terms of monitoring the activities of animals that have high site fidelity. The system can easily be modified to suit the requirements of studies on other animals, including more mobile animals, with the major modifications arising in the reading antennas. Future developments of this system could also include directionality information with the addition of a second antenna. Additionally, the low development costs (~\$130 - \$170 per reader) makes the system one of the most cost-effective systems available, thus opening up a market targeted for behavioural ecologists. Additionally, upgrades to the cellphone engine will not only allow for larger antennas for enhanced network reception, but through the addition of a built-in camera, one would be able to observe and compare the aligned behaviours of individuals to the data recorded by the ACRS, further enhancing the results of a particular study. Despite the future developments, the current system certainly has the potential to evolve behavioural studies.

The current dataset forms part of a larger study, in which all seasons will be considered. In addition to this, a larger dataset will allow for a better assessment of social interactions in Sungazers, and a fine-scaled analysis of shuttling behaviours. The inclusion of the temperature and humidity sensors to the ACRSs means that future work will be able to assess how these abiotic factors influence the activity of Sungazers. Marking individual Sungazers with PITs enables a long-term assessment on behaviours of the species to be conducted. As previously mentioned, mining contaminants influence physiological aspects of Sungazers (McIntyre & Whiting 2012). Thus, with the aid of the ACRSs, a study on the effects of mining and other anthropogenically-driven activities (including agriculture and pesticide treatments) on Sungazers would provide insightful data for the implementation of conservation strategies for the species. I highlight, again, the important finding that some, but not all Sungazers, were active during the winter season. This has opened a core research area as to the reason why this behaviour by those individuals is observed.

### **4.4 CONCLUSION**

This study has successfully designed a new, cost-effective autonomous PIT tag reader system that is effectively able to report on the activity patterns of Sungazers. The system is largely able to function maintenance-free for extended periods of time and provides researchers with



the opportunity to safely access data on activity patterns remotely, from any device with internet connectivity. Testing of this system has revealed insightful information regarding Sungazer activity across seasons. Finally, although only two seasons were considered during this study, it is evident that Sungazers display seasonal variation regarding activity patterns, and while Sungazers do brumate in winter, it is likely that activity during this time has important physiological implications associated with their wellbeing and reproductive cycles.

## REFERENCES

---

- Alexander, G. J. 2007. Thermal biology of the Southern African Python (*Python natalensis*). Pp. 51-75 in R. W. Henderson and R. Powell editors. *Biology of the Boas and Pythons*. Eagle Mountain Publishing Company, Eagle Mountain, Utah.
- Armstrong, A. J. 2011. Status of the Sungazer *Smaug giganteus* in Kwazulu-Natal Province, South Africa. *African Herp News* 54: 1-4.
- Avery, R. A. 1978. Activity Patterns, Thermoregulation and Food Consumption in two Sympatric Lizard Species (*Podarcis muralis* and *P. sicula*) from Central Italy. *The Journal of Animal Ecology* 47: 143–158.
- American Veterinary Identification Devices (AVID). 2003. Why EZ-ID Electronic Identification?. (15 November 2017; [www.ezidavid.com](http://www.ezidavid.com) ).
- Bates, M. F., Branch, W. R., Bauer, A. M., Burger, M., Marais, J., Alexander, G. J., De Villiers, M. S. (eds.). 2014. Atlas and Red List of the Reptiles of South Africa, Lesotho and Swaziland. Suricata 1. South African National Biodiversity Institute, Pretoria.
- Blouin-demers, G. & Weatherhead, P. J. 2001. Habitat use by black rat snakes (*Elaphe obsoleta obsoleta*) in fragmented forests. *Ecology* 82: 2882–2896.
- Blumstein, D. T., Mennill, D. J., Clemins, P., Girod, L., Yao, K., Patricelli, G., Deppe, J. L., Krakauer, A. H., Clark, C., Cortopassi, K. A., Hanser, S. F., Mccowan, B., Ali, A. M. & Kirschel, A. N. G. 2011. Acoustic monitoring in terrestrial environments using microphone arrays: Applications, technological considerations and prospectus. *Journal of Applied Ecology* 48: 758–767.
- Boarman, W. I., Beigel, M. L., Goodlett, G. C. & Sazaki, M. 1998. A passive integrated transponder system for tracking animal movements. *Wildlife Society Bulletin* 26: 886–891.
- Bond, M. H., Hanson, C. V., Baertsch, R., Hayes, S. A. & Macfarlane, R. B. 2007. A New Low-Cost Instream Antenna System for Tracking Passive Integrated Transponder (PIT)-Tagged Fish in Small Streams. *Transactions of the American Fisheries Society* 136: 562–566.
- Branch, W. R. 1998. Field Guide to Snakes and Other Reptiles of Southern Africa. Struik Publishers, Cape Town.
- Broekhoven, C. & Mouton, PLFN. 2015. Some like it hot: camera traps unravel the effects of weather conditions and predator presence on the activity levels of two lizards. *PLoS One* 10(9): 1–15.

- Brothers, N., Gales, R., Hedd, A. & Robertson, G. 1998. Foraging movements of the Shy Albatross *Diomdea cauta* breeding in Australia: Implications for interactions with longline fisheries. *IBIS* 140: 446–457.
- Brown, R. S., and Caputi, N. 1985. Factors affecting growth and survival of juvenile western rock lobsters, *Panulirus longipes*, George, returned by fishermen to the sea. *Fisheries Research* 2: 567–574.
- Butler, M. A. 2005. Foraging mode of the chameleon, *Bradypodion pumilum*: a challenge to the sit-and-wait versus active forager paradigm? *Biological Journal of the Linnean Society* 84: 797–808.
- Castro-Santos, T., Haro, A. & Walk, S. 1996. A passive integrated transponder (PIT) tag system for monitoring fishways. *Fisheries Research* 28: 253–261.
- Christian, K. A. & Weavers, B. W. 1996. Thermoregulation of Monitor Lizards in Australia : An Evaluation of Methods in Thermal Biology. *Ecological Monographs* 66: 139–157.
- Conway, C. J. & Gibbs, J. P. 2005. Effectiveness of call-broadcast surveys for monitoring marsh birds. *The Auk* 122: 26–35.
- Cooke, S. J., Hinch, S. G., Wikelski, M., Andrews, R. D., Kuchel, L. J., Wolcott, T. G. & Butler, P. J. 2004. Biotelemetry: a mechanistic approach to ecology. *Trends in Ecology and Evolution*. 19: 334–343.
- Cooke, S. J., Midwood, J. D., Thiem, J. D., Klimley, P., Lucas, M. C., Thorstad, E. B., Eiler, J., Holbrook, C. & Ebner, B. C. 2013. Tracking animals in freshwater with electronic tags: past, present and future. *Animal Biotelemetry* 1: 5.
- Cooper, E., Whiting, M. J. & Wyk, J. H. Van. 1997. Foraging modes of crocodyliform lizard. *South African Journal of Zoology* 32: 9–13.
- Collier, T. C., Kirschel, A. N. G. & Taylor, C. E. 2010. Acoustic localization of antbirds in a Mexican rainforest using a wireless sensor network. *Journal of the Acoustical Society of America* 128: 182–189.
- Costantini, D. & Møller, A. P. 2013. A meta-analysis of the effects of geolocator application on birds. *Current Zoology* 59: 697–706.
- Cucherousset, J., Roussel, J.-M., Keeler, R., Cunjak, R. A. & Stump, R. 2005. The Use of Two New Portable 12-mm PIT Tag Detectors to Track Small Fish in Shallow Streams. *North American Journal of Fisheries Management* 25: 270–274.
- Cutler, T. L. & Don, E. S. 1999. Using Remote Photography in Wildlife Ecology: A Review. *Wildlife Society Bulletin* 27: 571–581.

- de Waal, S. W. P. 1978. The Squamata (Reptilia) of the Orange Free State, South Africa. *Memoirs of the National Museum* 11.
- Dietz, R. & Heide-Jorgensen, M. P. 1995. Movements and swimming speed of narwhals, *Monodon monoceros*, equipped with satellite transmitters in Melville. *Canadian Journal of Zoology* 73: 2106–2119.
- Dillon, A. & Kelly, M. J. 2008. Ocelot home range, overlap and density: Comparing radio telemetry with camera trapping. *Journal of Zoology* 275: 391–398.
- Dixon, A., Ragyov, D., Purev-Ochir, G., Rahman, M. L., Batbayar, N., Bruford, M. W. & Zhan, X. 2016. Evidence for deleterious effects of harness-mounted satellite transmitters on Saker Falcons *Falco cherrug*. *Bird Study*: 1–11.
- Eifler, D. A., Eifler, M. A. & Eifler, E. N. 2007. Habitat use and movement patterns in the graceful crag lizard, *Pseudocordylus capensis*. *African Zoology* 42: 152–157.
- Ellinger, N., Schlatter, G., Jerome, N. & Hodl, W. 2001. Habitat use and activity patterns of the neotropical arboreal lizard *Tropidurus* (Uracentron) *Azureus weneri* (Tropiduridae). *Journal of Herpetology* 35: 395–402.
- Elliott, K. H., Mcfarlane-Tranquilla, L., Burke, C. M., Hedd, A., Montevecchi, W. A. & Anderson, W. G. 2012. Year-long deployments of small geolocators increase corticosterone levels in murrelets. *Marine Ecology Progress Series* 466: 1–7.
- Fair, W. S. & Henke, S. E. 1999. Movements, Home Ranges, and Survival of Texas Horned Lizards (*Phrynosoma cornutum*). *Journal of Herpetology* 33: 517–525.
- Fancy, S. G., Pank, L. F., Douglas, D. C., Curby, C. H., Garner, G. W. & Amstrup, S. C. 1988. Satellite telemetry: a new tool for wildlife research and management 172: 1–54.
- Finkenzeller, K. 2010. *RFID handbook: fundamentals and applications in contactless smart cards, radio frequency identification and near-field communication* (Third). John Wiley and Sons, Ltd.
- Fitzpatrick, J. W., Lammertink, M., Luneau, M. D. J., Gallagher, T. W., Harrison, B. R., Sparling, G. M., Rosenberg, K. V., Rohrbaugh, R. W., Swarthout, E. C. H., Wrege, P. H., Swarthout, S. B., Dantzker, M. S., Charif, R. A., Barksdale, T. R., Remsen, J. V. J., Simon, S. D. & Zollner, D. 2005. Ivory-billed Woodpecker (*Campephilus principalis*) persists in continental North America. *Science* 308: 1460–1462.
- Foa, A., Monteforti, G., Minutini, L., Innocenti, A., Quagliari, C. & Flamini, M. 1994. Seasonal changes of locomotor activity patterns in ruin lizards *Podarcis sicula*. *Behavioral Ecology and Sociobiology* 34: 267–274.

- Fogel, G. 2000. Observations on the giant sungazer lizard, *Cordylus giganteus*, in captivity. *Bulletin of the Chicago Herpetological Society* 35: 277–280.
- Garson, P. J. 1975. Social interactions of Woodmice (*Apodemus sylvaticus*) studied by direct observations in the wild. *Journal of Zoology* 147: 496–500.
- Gibbons, J. W. & Andrews, K. M. 2004. PIT Tagging : Simple Technology at Its Best. *BioScience* 54: 447–454.
- Glaudas, X. & Alexander, G. J. 2017. A lure at both ends: aggressive visual mimicry signals and prey-specific luring behaviour in an ambush-foraging snake. *Behavioral Ecology and Sociobiology* 71:1–7.
- Grace, J. K. 1990. Mark-recapture studies with *Reticulitermes flavipes* (Isoptera: Rhinotermitidae). *Sociobiology* 16: 297–303.
- Guan, R. Z. 1997. An improved method for marking crayfish. *Crustaceana* 70: 641–652.
- Harper, S. J. & Batzli, G. O. 1996. Monitoring the use of runways by voles with passive integrated transponders. *Journal of Mammology* 77: 364–369.
- Hays, G. C., Broderick, A. C., Godley, B. J., Luschi, P. & Nichols, W. J. 2003. Satellite telemetry suggests high levels of fishing-induced mortality in marine turtles. *Marine Ecology Progress Series* 262: 305–309.
- Hedd, A., Gales, R. & Brothers, N. 2001. Foraging strategies of Shy Albatross *Thalassarche cauta* breeding at Albatross Island, Tasmania, Australia. *Marine Ecology Progress Series* 224: 267–282.
- Heggøy, O., Aarvak, T., Øien, I. J., Jacobsen, K.-O., Solheim, R., Zazelenchuk, D., Stoffel, M. & Kleven, O. 2017. Effects of satellite transmitters on survival in Snowy Owls *Bubo scandiacus*. *Ornis Norvegica* 40: 33–38.
- Hill, R. D. 1994. Theory of geolocation by light levels. In: Elephant seals, population, ecology, behavior and physiology (B. J. Le Boeuf, and R. M. Laws, eds.), pp. 227–236. University of California Press, Berkeley, CA.
- Hill, G. E., Mennill, D. J., Rolek, B. W., Hicks, T. L. & Swiston, K. A. 2006. Evidence suggesting that ivory-billed woodpeckers (*Campephilus principalis*) exist in Florida. *Avian Conservation and Ecology - Écologie et conservation des oiseaux* 1(3): 2.
- Hubel, T. Y., Myatt, J. P., Jordan, N. R., Dewhirst, O. P., McNutt, J. W. & Wilson, A. M. 2016. Energy cost and return for hunting in African wild dogs and cheetahs. *Nature Communications* 7, 11034.
- Huey, R. B. & Pianka, E. R. 1981. Ecological consequences of foraging mode. *Ecology* 62: 991–999.

- Identipet. 2017.FDX-A Microchips (16 November 2017; [www.identipet.com/product/fdx-a-microchips/](http://www.identipet.com/product/fdx-a-microchips/)).
- Jacobsen, N. H. G., Newbery, R. E., Peterson, W. 1990. On the ecology and conservation status of *Cordylus giganteus* A. Smith in the Transvaal. *South African Journal of Zoology* 25: 61–66.
- Kays, R., Tilak, S., Crofoot, M., Fountain, T., Obando, D., Ortega, A., Kuemmeth, F., Mandel, J., Swenson, G., Lambert, T., Hirsch, B. & Wikelski, M. 2011. Tracking animal location and activity with an automated radio telemetry system in a tropical rainforest. *The Computer Journal* 54: 1931–1948.
- Keefer, M. L., Peery, C. P., Ringe, R. R. & Bjornn, T. C. 2004. Regurgitation Rates of Intra-gastric Radio Transmitters by Adult Chinook Salmon and Steelhead during Upstream Migration in the Columbia and Snake Rivers. *North American Journal of Fisheries Management* 24: 47–54.
- Kirchhof, S., Linden, J., Rödder, D. & Richter, K. 2010. Daily activity patterns of *Australolacerta rupicola* (FitzSimons, 1933) (Sauria: Lacertidae) with comments on niche segregation within a syntopic lizard community. *North-Western Journal of Zoology* 6: 172–181.
- Kirschel, A. N. G., Cody, M. L., Harlow, Z. T., Promponas, V., Vallejo, E. E. & Taylor, C. E. 2011. Territorial dynamics of Mexican Antthrushes revealed by individual recognition of their songs. *IBIS* 153: 255–268.
- Kolz, A. L., Lentfer, J. W. and Fallek, H. G. 1980. Satellite radio tracking of polar bears instrumented in Alaska. Pages 743–752 in C. J. Amlaner, Jr., and D. W. MacDonald, eds. A handbook on biotelemetry and radio tracking. Pergamon Press, Oxford. 804 pp.
- Knapp, C. R. & Owens, A. K. 2005. An Effective New Radio Transmitter Attachment Technique for Lizards. *Herpetological Review* 36: 264–266.
- Kucera, T. E. and Barrett, R. H. 1993. The trailmaster camera system for detecting wildlife. *Wildlife Society Bulletin* 21: 505–508.
- Kunz, T.H., 2001. Seeing in the dark: Recent technological advances for the study of free-ranging bats. *Bat Research News* 42: 91.
- Lemke, H. W., Tarka, M., Klaassen, R. H. G., Åkesson, M., Bensch, S., Hasselquist, D. & Hansson, B. 2013. Annual Cycle and Migration Strategies of a Trans-Saharan Migratory Songbird: A Geolocator Study in the Great Reed Warbler. *PLoS ONE* 8: 1–10.
- Lozano-Nieto, A., 2010. *RFID design fundamentals and applications*. CRC press.
- Madsen, T. 1984. Movements, Home Range Size and Habita Use of Radio-Tracked Grass

- Snakes (*Natrix natrix*) in Southern Sweden. *Copeia*: 707–713.
- Maritz, B. & Alexander, G. J. 2012a. Dwarfs on the move: spatial ecology of the world's smallest viper, *Bitis schneideri*. *Copeia* 2012: 115–120.
- Maritz, B. & Alexander, G. J. 2012b. Population density and survival estimates of the African viperid, *Bitis schneideri*. *Herpetologica* 68: 195–202.
- Mcgregor, P. K., Dabelsteen, T., Clark, C. W., Bower, J. L., Tavares, J. P. & Holland, J. 1997. Accuracy of a passive acoustic location system: empirical studies in terrestrial habitats. *Ethology Ecology and Evolution* 9: 269–286.
- Mcintyre, T. & Whiting, M. J. 2012. Increased metal concentrations in giant sungazer lizards (*Smaug giganteus*) from mining areas in South Africa. *Archives of Environmental Contamination and Toxicology* 63: 574–585.
- Measey, J. G., Stevenson, B. C., Scott, T., Altwegg, R. & Borchers, D. L. 2017. Counting chirps: acoustic monitoring of cryptic frogs. *Journal of Applied Ecology* 54(3): 894–902.
- Mennill, D. J., Battiston, M., Wilson, D. R., Foote, J. R. & Doucet, S. M. 2012a. Field test of an affordable, portable, wireless microphone array for spatial monitoring of animal ecology and behaviour. *Methods in Ecology and Evolution* 3: 704–712.
- Mennill, D. J., Doucet, S. M., Ward, K. A. A., Maynard, D. F., Otis, B. & Burt, J. M. 2012b. A novel digital telemetry system for tracking wild animals: A field test for studying mate choice in a lekking tropical bird. *Methods in Ecology and Evolution* 3: 663–672.
- Meyers, P. M., Hatch, S. A & Mulcahy, D. M. 1998. Effect of implanted satellite transmitters on the nesting behavior of murres. *Colonial Waterbirds* 100: 172–174.
- Montevicchi, W., Fifield, D., Burke, C., Garthe, S., Hedd, A., Rail, J.-F. & Robertson, G. 2012. Tracking long-distance migration to assess marine pollution impact. *Biology Letters* 8: 218–221.
- Nicholls, D. G., Robertson, C. J. R., Prince, P. A., Murray, M. D., Walker, K. J. & Elliott, G. P. 2002. Foraging niches of three Diomedea albatrosses. *Marine Ecology Progress Series* 231: 269–277.
- Nicholson, K. L., Torrence, S. M., Ghioca, D. M., Bhattacharjee, J., Andrei, A. E., Owen, J., Radke, N. J. A. & Perry, G. 2005. The Influence of Temperature and Humidity on Activity Patterns of the Lizards *Anolis stratulus* and *Ameiva exsul* in the British Virgin Islands. *Caribbean Journal of Science* 41: 870–873.
- Nowicki, P., Tirelli, T., Mussat Sartor, R., Bona, F. & Pessani, D. 2008. Monitoring crayfish using a mark-recapture method: Potentials, recommendations, and limitations. *Biodiversity and Conservation* 17: 3513–3530.

- Parusnath, S. 2014. A conservation assessment of the Sungazer (*Smaug giganteus*). MSc Dissertation. University of the Witwatersrand, Johannesburg, South Africa.
- Parusnath, S., Little, I., Cunningham, M. J., Jansen, R. & Alexander, G. J. 2017. The desolation of Smaug: The human-driven decline of the Sungazer lizard (*Smaug giganteus*). *Journal for Nature Conservation* 36: 48-57.
- Phillips, R. A., Xavier, J. C. & Croxall, J. P. 2003. Effects of satellite transmitters on albatrosses and petrels. *The Auk* 120: 1082–1090.
- Powell, L. A., Conroy, M. J., Hines, J. E., Nichols, J. D. & Krementz, D. G. 2000. Simultaneous use of mark-recapture and radiotelemetry to estimate survival, movement, and capture rates. *The Journal of Wildlife Management* 64: 302–313.
- Pradel, R. 1996. Utilization of capture-mark-recapture for the study of recruitment and population growth rate. *Biometrics* 52: 702–709.
- Pradhan, R. N., Shah, F. A., Arya, R. N. & Makhijani, K. M. 2013. 125 KHz RFID System. *Journal of Information, Knowledge And Research in Electronics and Communication Engineering* 2: 425–431.
- Prentice, E. F., Flag, T. A., Mccutcheon, C. S. & Brastow, D. F. 1990. PIT-tag monitoring systems for hydroelectric dams and fish hatcheries. *American Fisheries Society Symposium* 7: 323–334.
- Prentice, E. F. & Park, D. L. 1983. A Study to Determine the Biological Feasibility of a New Fish Tagging System. *Annual Report of Research*: 83–19.
- Rakus, K., Ronsmans, M. & Vanderplasschen, A. 2017. Behavioral fever in ectothermic vertebrates. *Developmental and Comparative Immunology* 66: 84–91.
- Rodríguez, A., Negro, J. J., Fox, J. W. & Afanasyev, V. 2009. Effects of geolocator attachments on breeding parameters of Lesser Kestrels. *Journal of Field Ornithology* 80: 399–407.
- Ropert-Coudert, Y. & Wilson, R. P. 2005. Trends and perspectives in animal-attached remote sensing. *Frontiers in Ecology and the Environment* 3: 437–444.
- Roussel, J.-M., Haro, A. & Cunjak, R. A. 2000. Field test of a new method for tracking small fishes in shallow rivers using passive integrated transponder (PIT) technology. *Canadian Journal of Fisheries and Aquatic Sciences* 57: 1326–1329.
- Ruddock, L. 2000. Social structure of the lizard, *Cordylus giganteus*. MSc Dissertation, University of Stellenbosch, Stellenbosch, South Africa.



- Ryan, M. P., Neuman-Lee, L. A., Durham, S. L., Smith, G. D. & French, S. S. 2018 (in press). A sex-dependent change in behavioral temperature regulation in African house snakes (*Lamprophis fuliginosus*) challenged with different pathogens. *Journal of Thermal Biology*.
- Schulte, U., Küsters, D. & Steinfartz, S. 2007. A PIT tag based analysis of annual movement patterns of adult fire salamanders (*Salamandra salamandra*) in a Middle European habitat. *Amphibia-Reptilia* 28: 531–536.
- Sharp, W. C., Lellis, W. A., Butler, M. J., Herrnkind, W. F., Hunt, J. H., Pardee-Woodring, M., Matthews. 2000. The use of coded microwire tags in mark-recapture studies of juvenile caribbean spiny lobster, *Panulirus argus*. *Journal of Crustacean Biology* 20: 510–521.
- Stanton-Jones, W. K., Parusnath, S. & Alexander, G. J. under review. The importance of posture and basking orientation to thermoregulation in the Sungazer (*Smaug giganteus*). *Journal of Thermal Biology*.
- Stutchbury, B. J. M., Tarof, S. A., Done, T., Gow, E., Kramer, P. M., Tautin, J., Fox, J. W. & Afanasyev, V. 2009. Tracking long-distance songbird migration by using geolocators. *Science* 323: 896.
- Teilmann, J., Born, E. W. & Acquarone, M. 1999. Behaviour of ringed seals tagged with satellite transmitters in the North Water polynya during fast-ice formation. *Canadian Journal of Zoology* 77: 1934–1946.
- Turchin, P. & Thoeny, W. T. 1993. Quantifying dispersal of Southern Pine Beetles with mark-recapture experiments and a diffusion model. *Ecological Applications* 3: 187–198.
- Ujvari, B. & Madsen, T. 2009. Increased mortality of naive varanid lizards after the invasion of non-native cane toads (*Bufo marinus*). *Herpetological Conservation and Biology* 4: 248–251.
- Van Wyk, J. H. 1988. Sungazer or giant girdled lizard (*Cordylus giganteus*). Pp. 78-80. In: W. R. Branch, editor, South African red data book - reptiles and amphibians. South African National Scientific Programmes Report No. 151
- Van Wyk, J.H. 1991. Biennial reproduction in the viviparous lizard, *Cordylus giganteus*. *Amphibia-Reptilia* 12: 329–342.
- Van Wyk, J.H. 1992. Life history and physiological ecology of the lizard, *Cordylus giganteus*. Unpublished PhD thesis. University of Cape Town, Cape Town, South Africa.

- Van Wyk, J.H. 2000. Seasonal variation in stomach contents and diet composition in the large girdled lizard, *Cordylus giganteus* (Reptilia: Cordylidae) in the Highveld grasslands of the northeastern Free State, South Africa. *African Zoology* 35: 9–27.
- Want, R. 2006. An Introduction to RFID technology. *IEEE pervasive computing* 5:2 5–33.
- Weber, C., Scheuber, H., Nilsson, C. & Alfredsen, K. T. 2016. Detection and apparent survival of PIT-tagged stream fish in winter. *Ecology and Evolution* 6: 2536–2547.
- Weimerskirch, H., Guionnet, T., Martin, J., Shaffer, S. A. & Costa, D. P. 2000. Fast and fuel efficient? Optimal use of wind by flying albatrosses. *Proceeding of the Royal Society of London, Series B* 267: 1869–1874.
- Williams, T. M., Wolfe, L., Davis, T., Kendall, T., Richter, B., Wang, Y., Bryce, C., Elkaim, G. H. & Wilmers, C. C. 2014. Instantaneous energetics of puma kills reveal advantage of felid sneak attacks. *Science* 346: 81–85.
- Wilson, A. M., Lowe, J. C., Roskilly, K., Hudson, P. E., Golabek, K. A. & McNutt, J. W. 2013. Locomotion dynamics of hunting in wild cheetahs. *Nature* 498: 185–189.
- Winne, C. T. & Keck, M. B. 2004. Daily activity patterns of Whiptail Lizards (Squamata: Teiidae: *Aspidoscelis*): a proximate response to environmental conditions or an endogenous rhythm? *Functional Ecology* 18: 314–321.
- Wone, B. & Beauchamp, B. 2003. Movement, Home Range, and Activity Patterns of the Horned Lizard, *Phrynosoma mcallii*. *Journal of Herpetology* 37: 679–686.
- Zamora-Camacho, F. J., Reguera, S., Moreno-Rueda, G. & Pleguezuelos, J. M. 2013. Patterns of seasonal activity in a Mediterranean lizard along a 2200 m altitudinal gradient. *Journal of Thermal Biology* 38: 64–69.
- Zulich, A. W., Hamper, D., Clark, B. & Peitz, T. 1992. A report on the use of implanted transponders for permanent identification of reptiles and amphibians. *Reptile and Amphibian Magazine*. September–October: 60–62.