

**WITS**  
UNIVERSITY



**Hydrometallurgical Extraction of Copper and Cobalt from Oxidised Copper-Cobalt Ore Using Ammonia Solution.**

**Seliee Thabane**

**1166813**

**A dissertation submitted to the Faculty of Engineering and the Built Environment at the University of Witwatersrand, Johannesburg, in part-fulfilment of the requirements for the degree of Master of Science in Engineering.**

**17 May 2018**

## **DECLARATION**

I declare that this dissertation is my own unaided work. It is being submitted for the Degree of Master of Science in Engineering to the University of the Witwatersrand, Johannesburg. It has not been submitted before for any other degree or examination in any other University.

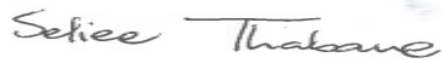
A handwritten signature in black ink that reads "Seliee Thabane". The signature is written in a cursive style with a horizontal line underlining the name.

**Seliee Thabane**

**May 2018**

## Abstract

Traditionally, copper and cobalt are extracted from oxidised ores via hydrometallurgical processing route. The ore is leached in sulphuric acid in reducing conditions. This method co-extracts impurity metal values like iron and manganese, necessitating downstream solution purification, which causes significant valuable losses. Pregnant leach solution purification is performed through step-wise oxidation and acid neutralisation of the leach solution. Cobalt is the most affected component in this process due to high losses incurred during the precipitation stages. Moreover, because the lixiviant is not recycled, the method consumes ominously high quantities of sulphuric acid. As a result, the process must be accompanied by readily available and cost-effective acid-making plant. In the event of an increase in the price of sulphuric acid raw materials or a decline in the ore grade, a source of 50% of the world's cobalt might be rendered impracticable.

This work investigates the viability of using ammoniacal solution as an alternative lixiviant to sulphuric acid. Ammoniacal solution forms soluble complexes with copper and cobalt at pH and potential where iron, manganese and other impurities tend to form precipitates. Because of the preferential leaching, downstream solution purification can be circumvented, thereby reducing valuable losses. Furthermore, because there is no solution altering, multi-step solution purification required, the leach solution retains its initial pre-leaching properties, making it fully recyclable. The recyclable nature of the lixiviant thus reduces lixiviant costs. Furthermore, an advantage of leaching in ammonia is lower equipment costs because ammonia is less corrosive than acid.

The feed material used in this study was an oxidised copper-cobalt ore sourced from Katanga Region in the DRC. A size fraction analysis was undertaken in order to determine the deportation of the copper and cobalt metals in the feed material. In the leaching tests conducted, the effect of particle size, temperature, concentration of the reducing agent and concentrations of ammonia and ammonium carbonate were investigated.

The results showed that a +63-75 $\mu$ m size fraction had the highest grade of copper and cobalt and was thus used for all the experiments undertaken. The results also indicated that cobalt and copper extraction was highly influenced by temperature. It was found that working at ambient temperature results in poor extraction of the value metal species while raising the temperature to 80°C significantly improves the extraction of both value metals if premature depressurising of the leach vessel is avoided.

The results also showed that there was no significant extraction advantage gained from milling finer than -63 $\mu$ m. Moreover, it was found that at 80°C, 2.0M ammonia solution, 0.4M ammonium carbonate, 300rpm, 0.4M reducing agent and 60 minutes pre-treatment and leach time, a peak extraction of 90% could be realised for copper. It was also noted that even better extraction efficiencies could be obtained for copper

in the absence of a reducing agent. Optimum cobalt extraction of 85% was obtained at 80°C, 2.0M ammonia solution, 2.0M ammonium carbonate solution, 0.4M ammonium sulphite, 60 minutes pre-treatment time and 60 minutes leaching time. This compares well to about 40-60% recovery reported when leaching in acid.

These findings point to the conclusion that ammoniacal solution is a viable alternative to sulphuric acid for hydrometallurgical processing of the copper-cobalt ore.

## ***Acknowledgements***

I would like to express deep and sincere gratitude to my supervisor, Prof. Selo Ndlovu, for her technical know-how, patience, insight, motivation, inspiration, suggestions and guidance throughout this work.

I would also like to express appreciation and gratitude to the Hydrometallurgy Research Group as well as Professors Merek Dworzanowski and Geoffrey Simate for their support and priceless input as I conducted this research work.

Special mention goes to young Mr. Leope Jimmy Thobejane, whose invaluable assistance and eventual friendship throughout the process of conducting this research work helped at times bring some much-needed method to the madness, and at times, useful madness to the method in the laboratory. Jimmy's company in the laboratory alleviated the tedium that can accompany laboratory work and helped make light work of the night-time laboratory work carried out during this research.

Additional heartfelt thanks go to Mr. Marlin Patchappa of the School of GeoSciences, Dr. Roy Forbes from the School of Chemistry and Messrs Mthunzi Mbense, Bruce Mothibeli and Motlatsi Phali from the School of Chemical and Metallurgical Engineering. Their assistance in the various analyses carried out in this work was instrumental in the completion of this work.

Last but certainly not least, I would like to express my never-ending unconditional love, appreciation and gratitude for the love and support I have received and continue to enjoy from my people. Nkepile Thokoa-Thabane, Mahlape Thabane, Boi Thabane, Kuena Thabane, Sophia Thabane, Letuma Thabane, Moliehi Thabane, 'Maletuma Malie, Teboho Malie, Nkhala Sefako and Hlompho Sefako, I love you, I could never have done this without you, *kea leboha Batebang*.

# Table of Contents

<b>Declaration</b> .....	<b>ii</b>
<b>Abstract</b> .....	<b>iii</b>
<b>Dedication</b> .....	<b>iv</b>
<b>Acknowledgements</b> .....	<b>v</b>
<b>1. Chapter 1</b>	
<b>Introduction</b> .....	<b>2</b>
1.1. Problem Identification .....	3
1.2. Research Objective .....	4
1.3. Research Questions .....	4
1.3.1. Research Approach .....	4
1.4. Report Layout.....	5
<b>2. Chapter 2</b>	
<b>Literature Review</b> .....	<b>6</b>
2.1. Introduction .....	6
2.2. Copper and Cobalt Occurrence .....	6
2.3. Traditional Processing of Copper and Cobalt Ores .....	7
2.3.1. Processing of Oxidised Copper-Cobalt Ores in the Central African Copperbelt .....	7
2.3.2. Pyro-Hydrometallurgical Processing of Sulphide Copper-Cobalt Ores .....	12
2.4. Processing of Cobalt Associated with Nickel .....	14
2.4.1. Processing of Cobalt in Nickel Laterite Ores .....	14
2.4.2. Processing of Cobalt Occurring in Nickel Sulphide Ores .....	16
2.5. Processing of Copper Ores .....	17
2.6. Alternative Hydrometallurgical Techniques for Copper and Cobalt Processing .....	19
2.6.1. Overview .....	19
2.6.2. Leaching of Copper and Cobalt Ores in Ammoniacal Solution .....	19
2.7. Cobalt Losses in Ammoniacal Leaching .....	27
Summary .....	30
<b>3. Chapter 3</b>	
3.1. Materials and Methods .....	32
3.2. Overview .....	32
3.3. Ore Preparation and Characterisation .....	32
3.4. Reagent Preparation .....	32
3.5. Experimental Procedure .....	33

3.5.1. The Effect of Reducing Agent Concentration .....	33
3.5.2. The Effect of Temperature .....	35
3.5.3. The Effect of Particle Size .....	36
3.5.4. The Effect of the Concentrations of Ammonia Solution and Ammonium Carbonate .....	37
3.6. Optimisation .....	38
3.6.1. Pre-Treatment .....	38
3.6.2. Diluting Samples in Hydrochloric Acid .....	40
3.7. Flowsheet Diagrams .....	40
<b>4. Chapter 4 .....</b>	<b>42</b>
<b>Results and Discussion .....</b>	<b>42</b>
4.1. Ore Composition .....	42
4.2. The Effect of Reducing Agent Concentration .....	43
4.3. The Effect of Temperature .....	47
4.4. The Effect of Particle Size .....	49
4.5. Troubleshooting and Optimising Cobalt Extraction .....	50
4.6. The Effect of the Concentrations of Ammonia Solution and Ammonium Carbonate .....	54
Summary .....	64
<b>5. Chapter 5</b>	
<b>Conclusions and Recommendations .....</b>	<b>69</b>
5.1. The Effect of Reducing Agent Concentration .....	69
5.2. The Effect of Temperature .....	69
5.3. The Effect of Particle Size .....	70
5.4. The Effect of the Concentrations of Ammonia Solution and Ammonium Carbonate .....	70
5.5. Recommendations .....	71
<b>References .....</b>	<b>74</b>

## List of Figures:

Figure 2.1(a) Typical Flowsheet of Traditional Processing of Copper-Cobalt Oxide Ores as per Crundwell et al., 2011.....	8
Figure 2.1(b) Generic Copper-Cobalt Recovery flow diagram as per Fischer, 2011. ....	9
Figure 2.2. Typical process flowsheet for copper-cobalt sulphide processing for African Copperbelt sulphide ores per Crundwell et al., 2011. ....	13
Figure 2.3. Generic hydrometallurgical processing of copper (Schlesinger et al., 2011). ....	18
Figure 2.4. Cu-NH <sub>3</sub> -(NH <sub>4</sub> ) <sub>2</sub> CO <sub>3</sub> ; Co-NH <sub>3</sub> -(NH <sub>4</sub> ) <sub>2</sub> CO <sub>3</sub> ; Fe-NH <sub>3</sub> -(NH <sub>4</sub> ) <sub>2</sub> CO <sub>3</sub> and Mn-NH <sub>3</sub> -(NH <sub>4</sub> ) <sub>2</sub> CO <sub>3</sub> Pourbaix Diagrams per Welham et al., 2015. ....	20
Figure 2.5. Proposed Flowsheet for Ammonia Leaching as per Welham et al., 2015. ....	21
Figure 3.1: Schematic Diagram of Laboratory Equipment.....	31
Figure 3.2(a): Leaching flow diagram for Preliminary Tests. ....	40
Figure 3.2(b): Optimised Flowsheet for Leaching .....	40
Figure 4.1(a) (i): Preliminary Investigation of the Effect of a Reducing Agent. ....	44
Figure 4.1(a) (ii): Preliminary Investigation of the Effect of a Reducing Agent Showing Changes in Leaching Efficiency with Time at 0.1M Ammonium Sulphite. ....	44
Figure 4.1(b): The Effect of Reducing Agent Concentration on Leaching at 60°C. ....	45
Figure 4.1(c): The Effect of Reducing Agent Concentration on Leaching with Increased Reagent Concentrations. ....	46
Figure 4.2: The Effect of Temperature on Leaching. ....	47
Figure 4.3: The effect of particle size distribution on leaching efficiency. ....	49
Figure 4.4: The Effect of Leaching at 80°C. ....	52
Figure 4.5: The Effect of Reducing Agent Concentration with Optimised Conditions Employed.....	53
Figure 4.6(a): The Effect of Changing Ammonia Solution Concentration at Fixed 0.1M Ammonium Carbonate. ....	54



Figure 4.6(b) The Effect of Changing concentration of Ammonia Solution at Fixed 0.2M Ammonium Carbonate. ....	55
Figure. 4.6(c): The Effect of Changing Ammonia Solution Concentration at Fixed 0.4M Ammonium Carbonate. ....	57
Figure 4.6(d): The Effect of Changing Ammonia Solution Concentration at Fixed 1.0M Ammonium Carbonate. ....	58
Figure 4.6(e): The Effect of Changing Ammonia Solution Concentration at Fixed 2.0M Ammonium Carbonate. ....	59
Figure 4.6(f): The Effect of Changing Ammonia Solution Concentration at Fixed 4.0M Ammonium Carbonate. ....	60
Figure 4.6(g): The Effect of Ammonia Solution and Ammonium Carbonate on Copper Extraction. ....	62
Figure 4.6(h): The Effect of Ammonia Solution and Ammonium Carbonate on Cobalt Extraction. ....	63
Figure 4.7: Proposed Flowsheet for Leaching the Resource as per Findings. ....	68

## List of Tables.

Table 2.1: Predominant Species in Ammonia-Ammonium Salt at pH 9.0-9.5 and 25°C (Achadrya and Das, 1987). .....	22
Table 3.1(a): Preliminary Investigation on the effect of the concentration of reducing agent on leaching. ....	32
Table 3.1(b) The Effect of Reducing Agent Concentration at 60°C. ....	35
Table 3.1(c): The effect of Reducing Agent Concentration at Increased Concentration of Reducing Agent. ....	35
Table 3.2: The effect of temperature on leaching. ....	36
Table 3.3: The effect of particle size on leaching. ....	37
Table 3.4: The Effect of Ammonia and Ammonium Carbonate Concentrations on Leaching. ....	38
Table 4.1 (a): Elemental Analysis by size of the ore material. ....	42
Table 4.1 (b) Ore Mineral Phase Analysis (Kyembo, 2015). ....	42

## **APPENDICES**

Appendix 1: The Effect of Reducing Agent Concentration .....	77
Appendix 2: The Effect of Temperature. ....	81
Appendix 3: The Effect of Particle Size. ....	83
Appendix 4: The Effect of the Concentrations of Ammonia Solution and Ammonium Carbonate.....	84

## **DEDICATION**

I dedicate this work to the powerful women that influenced it. They are Professor Selo Ndlovu, Mrs. Kuenta Thabane, Mrs Nkepile Thokoa-Thabane, Dr. Sophia Thabane, Mrs. 'Maletuma Malie, Mrs. Nkhala Sefako and Ms. Mahlape Thabane.

# Chapter 1

## Introduction

Copper and cobalt are valuable metals that are used extensively in industry. Copper is malleable, ductile, corrosion-resistant and an excellent conductor of heat and electricity. These characteristics have been exploited singularly or in combination for use of copper in the construction industry, power generation and transmission, electronic products manufacturing as well as the production of industrial machinery and transportation vehicles (Doebrich and Masonic, 2009). Copper also has excellent alloying properties. Alloys of copper improve its already attractive properties. For instance, copper can be combined with tin to make bronze and with zinc to make brass. Moreover, copper-nickel alloy is used to construct ship hulls that are resistant to corrosion in sea water and are difficult for marine life like barnacles to adhere to. Barnacles attach themselves to ships and boats increasing drag and reducing fuel efficiency (Doebrich and Masonic, 2009). More recently, copper has been alloyed with silicon to make computer microprocessors that are faster and use less energy.

Cobalt was only isolated as a metal in 1735 (Boland and Kropschot, 2011) and has found extensive industrial application. For many years, it has found use as a dark blue pigment in glass. Cobalt is also used in the manufacture of super-alloys. Super-alloys are metal alloys that retain their properties at very high temperatures. Cobalt-containing alloys retain their strength, corrosion resistance and magnetic properties at temperatures in excess of 1000°C. These super-alloys are used in the construction of gas turbine engines and other components used in aircraft and space vehicles, chemical and petroleum plants as well as power-plants. Cobalt-containing super-alloys are also important components of the magnets used in computer disc drives, electric motors and in rechargeable batteries (Boland and Kropschot, 2011).

Cobalt is mostly recovered as a valuable by-product of other more abundant metals. It exists linked with copper in mixed copper-cobalt ores found in the Central African Copperbelt that spreads from Zambia into the Democratic Republic of Congo. This deposit is about 50% of the world's source of cobalt and 10% of the world's copper (Crundwell et al., 2011). As a result, in the Central African Copperbelt, the production of cobalt is linked with the production of copper. Cobalt also exists associated with nickel ores in the mineral pentlandite ((Ni,Fe,Co)<sub>9</sub>S<sub>8</sub>) and in oxidised nickel laterite ores where it is associated with minerals like goethite ((Fe,Ni,Co)OOH). Copper is however, more abundant than cobalt. In addition to the mixed copper-cobalt ores of the Central African Copperbelt, copper is also found in porphyry deposits in South America where 50% of the world's supply can be found. The rest of the world's copper

is spread around the world and is found in minerals like chalcopyrite ( $\text{CuFeS}_2$ ) and malachite ( $\text{CuCO}_3 \cdot \text{Cu(OH)}_2$ ).

The subject of this research project is an oxidised copper-cobalt ore sourced from the Katanga district in the Democratic Republic of Congo. Typically, this oxidised ore is a mixture of heterogenite ( $\text{CoOOH}$ ) and sphaerocobaltite ( $\text{CoCO}_3$ ), associated with malachite ( $\text{CuCO}_3 \cdot \text{Cu(OH)}_2$ ) and chrysocolla ( $\text{CuO} \cdot \text{SiO}_2 \cdot \text{H}_2\text{O}$ ) hosted in dolomite ( $\text{CaCO}_3 \cdot \text{MgCO}_3$ ) or quartz ( $\text{SiO}_2$ ) gangue.

Copper-cobalt ores are processed via hydrometallurgical and pyrometallurgical routes. Oxidised copper-cobalt ores are treated via a hydrometallurgical route. The ore is leached in sulphuric acid in the presence of a reducing agent. The reducing agent commonly used is sodium metabisulphite (Crundwell et al., 2011) but sulphur dioxide (Mwema et al., 2002; Ferron, 2008), ferrous ions (Apua and Mulaba-Bafubiandi, 2011), ammonium thiosulphate and ammonium sulphite (Niinae et al., 1994), sodium sulphite (Welham et al., 2015) and even glucose (Das et al., 1986) have also been investigated with positive results. These reducing agents are required to ensure high recovery of cobalt as the trivalent oxidation state of cobalt is insoluble in aqueous solution. This reductive leaching also manages to dissolve other metallic species like iron, manganese, zinc and aluminium into solution. These are undesirable in the pregnant leach solution and need to be removed before metal recovery.

The impurity metal ions do not pose a processing threat to the copper recovery because copper can be removed from the pregnant leach solution through the established process of selective solvent extraction. Obtaining a selective solvent extraction route for cobalt is however, a major challenge (Kyembo, 2015) and as yet no extractant capable of selectively extracting cobalt from a pregnant leach solution containing iron, manganese and other dissolved impurity ions has been identified. Currently, these impurity metal ions are removed from solution by a multi-stage selective precipitation technique that uses pH manipulation and controlled oxidation (Crundwell et al., 2011). Since oxidation is employed, it is possible to precipitate cobalt at each precipitation step resulting in significant cobalt losses through co-precipitation and adsorption on iron and manganese.

Leaching copper and cobalt in sulphuric acid also characteristically consumes large quantities of acid. This is because for every processing cycle the acid lixiviant enters the process at pH 1.5. It is progressively neutralised as selective precipitation of the gangue metals is effected and finally neutralised to pH 8.8 so as to precipitate cobalt hydroxide (Crundwell et al., 2011). This means that the lixiviant is not recycled and fresh acid is required for each production cycle. The fact that lixiviant pH needs to be maintained by addition of fresh acid (Crundwell et al., 2011) means that acid consumption is very high.

## **1.1. Problem Identification**

The currently employed method for copper and cobalt extraction through reductive acidic leaching of the oxidised copper-cobalt ore coupled with copper solvent extraction and selective precipitation of impurity metals from the cobalt-rich pregnant leach solution, results in significant cumulative losses of cobalt through co-precipitation and adsorption. These losses have been observed in plants in Tenke and Ligasi in the DRC (Welham et al., 2015). Although it is a fact that with the current method, certain cobalt losses have to be accepted (Crundwell et al., 2011), these losses can however be as high as 50% (Welham et al., 2015), which is unacceptable. Cobalt is the most valuable metal in the copper-cobalt ore body and such high losses mean significant revenue losses. Secondly, the acid consumption of the reductive acid leach process is ominously high because the process route effectively neutralises the acid when effecting selective impurity precipitation and cobalt hydroxide precipitation. This means that for every leaching cycle, the lixiviant must be replenished with significant volumes of fresh acid. Thus, for the process to remain viable, the cost of acid has to be very low. As such, there must be either a readily available source of cheap acid or an acid-making unit which uses cheap raw materials and is cheap to run that is linked to the plant. In the absence of cheap acid and sufficiently high grade ore, the exploitation of an important source of the world's cobalt could be rendered intractable.

To ensure that a source of half the world's cobalt remains viable, it is prudent to investigate an alternative leaching solution that can eliminate the problems associated with acid leaching. Therefore, this research work investigates basic ammonia/ammonium salt direct ore leaching of mixed copper-cobalt ore as an alternative.

Thermodynamic data shows that at a pH of 8.5-10.5, copper and cobalt ammine complexes are stable while iron and manganese are more stable as oxides or hydroxides at the same pH. Thus, theoretically, using ammonia solution as a lixiviant has the possibility of selectively leaching cobalt and copper and rejecting manganese and iron. This means that the multi-stage pregnant leach solution purification step performed in acid leaching is eliminated. Eliminating this step has the advantage of reducing cobalt losses.

Furthermore, unlike in acid leaching, the high oxidation state of cobalt is stable in aqueous solution as an ammine complex while iron and manganese do not form ammine complexes in their high oxidation states. This means that in the event that there are traces of leached iron and manganese, they can be rejected by oxidation without incurring cobalt losses.

## **1.2. Research Objective**

The objective of this research is to investigate the selectivity of copper and cobalt leaching in ammonia/ammonium solutions over impurities such as iron and manganese, which tend to co-dissolve during the traditional leaching process. The specific aims are:

- i) To determine the extent of dissolution of copper and cobalt in ammonia solution;
- ii) To investigate the extent of rejection of impurities like iron and manganese when using ammonia solution;
- iii) To investigate the effect of adding ammonium sulphite and the optimum level required for high recovery of copper and cobalt and low recovery of manganese and iron;
- iv) To investigate the effect of temperature on the extent of dissolution of copper and cobalt and rejection of iron and manganese;
- v) To investigate the effect of particle size distribution on the extent of dissolution of copper and cobalt and rejection of iron and manganese;
- vi) To investigate the effect of concentration of ammonia solution on the extent of dissolution of copper and cobalt and rejection of iron and manganese;
- vii) To investigate the effect of the concentration of ammonium carbonate on the extent of dissolution of copper and cobalt and rejection of iron and manganese.

### **1.3. Research Questions**

Questions that need to be answered by the research study are as follows:

- i) To what extent can copper and cobalt be recovered from a low grade copper-cobalt ore by ammonia leaching?
- ii) To what extent can iron and manganese be rejected when leaching in ammonia?
- iii) Which leaching conditions will result in a maximum for question i) and a maximum of question ii)?

#### **1.3.1. Research Approach**

To arrive at a well-articulated answer to the questions asked in 1.3 above, the following methodology is necessary:

- i) Characterise the ore by X-ray fluorescence (XRF) to determine the quantitative elemental composition of the ore;
- ii) Characterise the ore material by X-ray diffraction (XRD) to determine the mineral phases in the ore;
- iii) Leaching of the ore in varied conditions to study or investigate: concentration of reducing agent, particle size distribution, temperature, concentration of ammonium salt and concentration of ammonia solution;



- iv) Analysis of the resultant pregnant leach solutions for copper, cobalt, iron and manganese using atomic absorption spectroscopy (AAS/AA);
- v) Use of the results obtained from XRF and AA to determine the extraction efficiency of the tested conditions.

#### **1.4. Report Layout**

This report consists of five chapters. These are:

Chapter 1: The introduction and Study motivations;

Chapter 2: The literature review;

Chapter 3: The experimental methodology;

Chapter 4: The results and discussions;

Chapter 5: The conclusions and recommendations.

# Chapter 2

## Literature Review

### 2.1. Introduction

With progress in industrialisation, the demand for copper and cobalt has grown steadily, with the United States and China being the biggest consumers of these metals. This chapter aims to discuss the occurrence of copper and cobalt and the current industrial practice in the extraction of copper and cobalt. The chapter will also discuss research in the hydrometallurgical processing of copper and cobalt ores, more specifically; research which has considered alternative approaches to the current industrial practice.

### 2.2. Cobalt and Copper Occurrence

About 10% of the world's copper supply and 50% of the world's cobalt supply comes from the Central African Copperbelt that stretches from Zambia into the Democratic Republic of Congo (Crundwell et al, 2011; Cailteux et al., 2005). The other 50% of the world's cobalt supply comes as a valuable by-product of ferronickel processing. Cobalt occurs in the Central African Copperbelt with copper sulphide as the mineral carrollite ( $\text{Co}_2\text{CuS}_4$ ). This mineral occurs in association with chalcocite ( $\text{Cu}_2\text{S}$ ) and digenite ( $\text{Cu}_9\text{S}_5$ ) at depths of about 250m and deeper. Nearer to the surface, the ore material is weathered by natural elements and cobalt is thus, found as heterogenite ( $\text{CoOOH}$ ) and sphaerocobaltite ( $\text{CoCO}_3$ ), associated with malachite ( $\text{CuCO}_3 \cdot \text{Cu}(\text{OH})_2$ ) and chrysocolla ( $\text{CuO} \cdot \text{SiO}_2 \cdot \text{H}_2\text{O}$ ) hosted in dolomite ( $\text{CaCO}_3 \cdot \text{MgCO}_3$ ) and quartz ( $\text{SiO}_2$ ) gangue (Crundwell et al, 2011; Cailteux et al., 2005 and Dewaele et al., 2006). Cobalt also exists in association with manganese wads in the ore (Dewaele et al., 2006; Cailteux et al., 2005). It follows that the production of cobalt in the Central African Copperbelt is tied to the production of the more abundant copper (Crundwell et al, 2011 and Fischer, 2011).

Cobalt is also commonly extracted as a by-product in nickel production. It occurs in the mineral pentlandite  $(\text{Ni,Fe,Co})_9\text{S}_8$ . The concentration of cobalt in pentlandite ores ranges between 0.8-1.4% while nickel is about 36% (Crundwell et al., 2011). Cobalt also occurs in nickel laterite ores, which are oxidised, nickel ores occurring in association with iron. Cobalt is recovered in limonitic layers of the laterite ores where it is hosted in goethite  $(\text{Fe,Ni,Co})\text{OOH}$  (Crundwell et al., 2011) and in manganese wads (Dewaele et al., 2006; Caliteux et al., 2005).

About 50% of the world's copper supply is also found in porphyry deposits in South American countries like Chile and Peru where it occurs in sulphide minerals like chalcopyrite ( $\text{CuFeS}_2$ ), chalcocite ( $\text{Cu}_2\text{S}$ ), bornite ( $\text{Cu}_5\text{S}_4$ ), digenite ( $\text{Cu}_9\text{S}_5$ ) and covellite ( $\text{CuS}$ ). The metal also exists in oxide minerals like cuprite ( $\text{Cu}_2\text{O}$ ), malachite

( $\text{CuCO}_3 \cdot \text{Cu}(\text{OH})_2$ ) and chrysocolla ( $\text{CuO} \cdot \text{SiO}_2 \cdot \text{H}_2\text{O}$ ). Copper ores always occur with impurity metals like iron, zinc, selenium, arsenic, nickel, antimony, tellurium, tin, lead and cobalt (Crundwell et al 2011 and Davenport et al., 2002). Other oxidised copper and cobalt minerals found in the Central African Copperbelt are cuprite  $\text{Cu}_2\text{O}$ , cornetite  $\text{Cu}_3(\text{PO}_4)(\text{OH})_3$ , libethenite  $\text{Cu}_2(\text{OH})\text{PO}_4$ , pseudomalachite  $\text{Cu}_5(\text{OH})_4(\text{PO}_4) \cdot \text{H}_2\text{O}$  and kolwezite  $(\text{Cu},\text{Co})_2(\text{CO}_3)(\text{OH})_2$  (Prasad, 1989).

### **2.3. Traditional Processing of Copper and Cobalt Ores**

This research work seeks to investigate an alternative route to the current industrial practice of the processing of copper and cobalt ores. As such, it is fitting to examine in depth some of the copper and cobalt processing techniques and note the advantages and disadvantages of each processing technique. It is also prudent to investigate published research work completed by other researchers on the subject in order to see how their findings can assist this research work. This section will examine the work done in the processing of mixed copper-cobalt ores, individual copper ores and mixed nickel-cobalt ores.

#### **2.3.1 Processing of Copper Cobalt Ores in the African Copperbelt using Hydrometallurgical Techniques**

According to Crundwell et al (2011), Mwema et al. (2002) and Apua and Mulaba-Bafubiandi (2011), the oxidised copper-cobalt ore from the Central African Copperbelt is processed via hydrometallurgy using sulphuric or hydrochloric acid in the presence of a reducing agent. This results in the production of leach liquor containing copper and cobalt ions. The use of a reducing agent is necessary when the mineral assemblages contain high oxides of cobalt i.e. the trivalent cobalt. In contrast to copper oxide minerals which readily dissolve in the sulphuric acid solution, the high oxides of cobalt e.g. the trivalent oxidation state ( $\text{Co}_2\text{O}_3$ ) are difficult to dissolve. The insoluble form of  $\text{Co}^{3+}$  only becomes soluble after reduction to  $\text{Co}^{2+}$ . This therefore, means that the hydrometallurgical dissolution of cobalt, especially in the oxidation state 3+, can only be possible in the presence of a reducing agent. The most commonly used reducing agent in industry is sodium metabisulphite. However, other reducing agents such as sulphur dioxide (Ferron, 2008; Mwema et al., 2002); ferrous ions (Apua and Mulaba-Bafubiandi, 2011); manganous ions (Achandrya and Das, 1987); sodium sulphite (Welham et al., 2015); ammonium thiosulphate (Niinae et al.; 1994) and ammonium sulphite (Niinae et al., 1994) have also been used in research and in industry.

During the leaching process, impurity elements such as aluminium, iron, manganese and zinc are also co-leached. After the leaching process, the impure Cu-Co bearing aqueous solution is then purified subsequently recovering copper and cobalt by electrowinning. In order to produce high grade copper, the recovery of copper from the resulting solution is best accomplished by means of copper solvent extraction followed by electrowinning (SX-EW). In the past, cathodic cobalt was produced out

of the bleed of copper electrowinning (Prasad, 1989). However, the impurity elements need to be removed to prevent the contamination of cobalt at the cathode. In the current processes used in the DRC, iron, manganese and aluminium are removed by neutralisation. Zinc, copper and nickel co-deposit with cobalt during electrowinning therefore, these impurities also need to be removed. Manganese does not co-deposit with cobalt but its presence in the electrolyte at high concentrations can adversely affect the electrowinning of cobalt by reducing the current efficiency (Crundwell et al., 2011; Fischer, 2011 and Welham et al., 2015).

Typical flowsheets of the leaching of the ore as taken from the *Tenke Fungurume* plant in the Democratic Republic of Congo are shown in Figure 2.1(a) and 2.1(b) below:

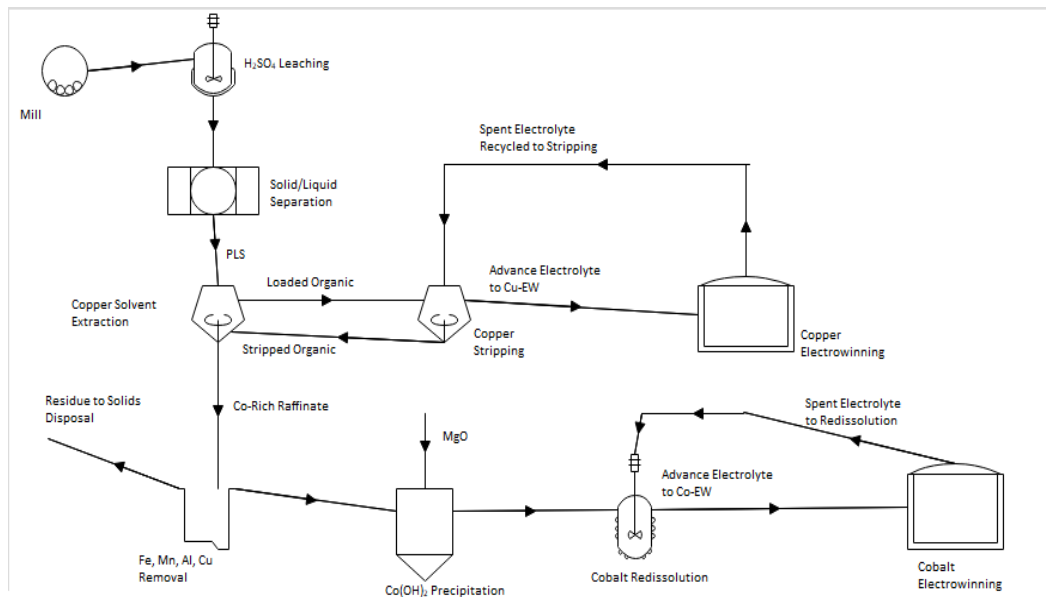

Figure 2.1 (a): Typical Flowsheet of Traditional Processing of Copper-Cobalt Oxide Ores. (Crundwell et al., 2011)

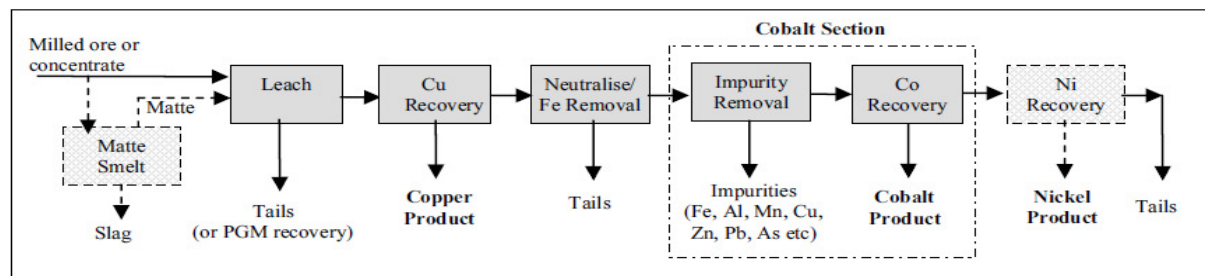

Figure 2.1(b) Generic Copper-Cobalt Recovery flow diagram (Fischer, 2011).

Figures 2.1 (a) and 2.1 (b) show that copper can be preferentially separated from other metal ions in the pregnant leach solution. This is achieved by using solvent extraction. Although a subject of ongoing test work (Kyembo, 2015), there has not been an identified solvent extractant capable of selectively extracting cobalt from copper, iron,

manganese and aluminium. The precipitation step of manganese, iron, aluminium and copper is a multi-stage process where the leach solution is oxidised with a controlled mixture of air and sulphur dioxide, while the pH of the solution is raised to 3.2 with limestone to precipitate the iron and manganese as trivalent carbonates. The solution pH is further raised to 4.7 to precipitate aluminium and then to 6.0 to precipitate any residual copper and zinc (Crundwell et al., 2011).

It is easy to see why the reductive acid leaching process route is attractive. There is a ready supply of sulphur that is available cheaply from the petroleum industry (Fischer, 2011). In a move by world governments and international organisations to address *inter alia* atmospheric pollution from sulphur dioxide from burning of fossil fuels, the grade of sulphur in diesel was regulated to be not greater than 500ppm sulphur (S.A. Govt. Gazette No. 28958 of 23 June 2006; SA Govt. Gazette No. 28191 of 4 November 2005). This means that the petroleum industry has a significant stock of sulphur gangue that can be sold cheaply.

There is high and reasonably rapid extraction of cobalt and copper into solution by the reductive acid leaching process. There exists established, tried, tested and proven technology to produce high purity copper from the process by solvent extraction and electrowinning. With stringent process control in the subsequent cobalt production section, this process route still represents a vast improvement in cobalt extraction and recovery compared to the process route of smelting. Cobalt smelting results in cobalt losses to slag of between 25-80% (Crundwell et al., 2011; Fischer, 2011) because cobalt tends to slag with iron in smelting (Fischer, 2011). However, it should be noted that the multi-stage precipitation step has the possible undesirable effect of precipitating some of the cobalt at every individual step. This means that without careful process control, it is possible to lose significant amounts of cobalt of up to 50% (Welham et al., 2015). Cobalt is the more valuable metal of the two, and such high losses result in considerable revenue losses.

The reductive acid leaching process technique also relies heavily on the availability of cheap sulphuric acid as the process consumes large amounts of sulphuric acid. This ominously high consumption of acid happens in several ways. Firstly, if the ore material is hosted in dolomite gangue, the carbonate consumes the acid and to maintain the leaching kinetics, the acid has to be replenished to maintain the appropriate pH levels. After the removal of copper by solvent extraction, the raffinate solution is henceforth called cobalt-rich pregnant leach solution (Co-rich PLS). The Co-rich PLS needs to be purified by controlled oxidation and pH manipulation, which means progressively neutralising the acid. The solution needs to be oxidised to convert iron and manganese species to trivalent and/or tetravalent species, which renders them practically insoluble at pH as low as pH 3. This controlled oxidation step can also convert the cobalt in solution to trivalent cobalt which would then be lost to residue. As such, after the controlled oxidation step, the pH is raised to pH 3.2 to remove iron and manganese as  $\text{Fe}^{3+}$  and  $\text{Mn}^{3+}$  and  $\text{Mn}^{4+}$  species which tend to precipitate from aqueous solution. The pH is then raised to 4.7 to remove aluminium from solution and

then to 6.5 to remove zinc and any residual copper. In the next step, the pH is raised to pH 8.8 to precipitate cobalt hydroxide (Crundwell et al, 2011 and Welham et al., 2015). The pH is raised by adding either caustic soda (NaOH), lime (Ca(OH)<sub>2</sub>) or limestone (CaCO<sub>3</sub>). These are consumed and not regenerated; adding to production costs. At the end of one leach-purification-metal production cycle, the lixiviant is at a basic pH and the next cycle requires fresh acid. Therefore, this means that more research into the improvement of the method is necessary.

Hydrochloric acid leaching in the presence of ferrous ions as a reducing agent (Apua and Mulaba-Bafubiandi, 2011) does not provide a compelling argument as an alternative to the current process. Hydrochloric acid leaching uses hydrochloric acid which causes potential equipment corrosion problems. High acid consumption is still a problematic concern in this process because the process route is similar to the sulphuric acid process route. Although sulphuric acid costs can currently be mitigated by the cheap supply of elemental sulphur from the petroleum industry (Fischer, 2011), there is no industry producing a cheap supply of any of the raw materials for the manufacture of hydrochloric acid. Furthermore, to enhance cobalt dissolution, the process introduces divalent iron ions into the solution. This means that there has to be a downstream process that removes this added iron as well as the iron that was initially present in the ore but inevitably co-leached. Research work by Dyer et al., 2012; Feurstenau and Osseo-Assare, 1987; Osseo-Assare and Feurstenau, 1980 and Osseo-Assare et al., 1983 has found that in principle, higher iron concentration in the pregnant leach solution results in higher co-precipitation of cobalt when purifying the cobalt-rich pregnant leach solution. It suffices then to argue that using ferrous ions as a reducing agent is undesirable because it increases the concentration of iron in the leach solution, which may result in increased losses of cobalt as the iron is rejected downstream. Although the work reported high extraction of cobalt and copper into solution, it did not address the downstream processes of cobalt-rich PLS purification and lixiviant regeneration. The work also did not present itself as a viable alternative to sulphuric acid leaching and therefore could not challenge the traditional copper and cobalt ores processing practice.

There are other hydrometallurgical process routes of mixed copper-cobalt ores that have lost favour (Prasad, 1989). One of the process routes entails partially leaching the ore in dilute sulphuric acid, solid/liquid separation then purifying the pregnant leach solution to remove iron presumably by oxidation and pH manipulation to get “pure” leach liquor that can be used to produce copper by electrowinning. The iron in solution is presumably rejected as jarosite. It is not clear how much cobalt is lost in the iron rejection step, but it is easy to imagine that a significant amount of cobalt is lost. This process route lost favour possibly because it was not as profitable as was desirable. There is no mention of a reducing agent in the process route so clearly only cobalt existing in divalent oxidation state was leached. Any cobalt recovery was due to the rich ore body and accumulation of cobalt in the leach solution as the leach solution underwent successive recycles. The processing route does not mention copper

solvent extraction. This means that the advance pregnant leach solution for copper electrowinning contained cobalt. The cobalt was extracted from the bleed of the spent acid solution from copper electrowinning. In this process route, the cobalt was precipitated by neutralising the solution to pH 8.2 and re-leaching the resulting precipitate in sulphuric acid, and taking the solution to cobalt electrowinning.

Test work (Ferron, 2008; Welham et al., 2015; Vu et al., 1980; Apua and Mulaba-Bafubiandi, 2011) shows that cobalt extraction in acid leaching cannot be significantly improved beyond 10% in the absence of a reducing agent. This means that 90% of the cobalt in the assay is lost to tailings in the primary leaching. Furthermore, the cobalt may be lost to the residue when the advance electrolyte is purified of iron. Test work by Sharma et al., 2005 revealed that some cobalt from cobalt electrowinning precipitated on the anode as trivalent cobalt oxide ( $\text{Co}_2\text{O}_3$ ) but such losses were reported as not significant since the precipitated cobalt (III) oxide was a small fraction of the cobalt metal recovered. Furthermore, there was no work done to assess the extent of the effect of this side reaction in cobalt electrowinning. It is not very far-fetched to imagine this side reaction of cobalt oxidation and precipitation occurring in copper electrowinning, especially in the process described by Prasad, 1989, where cobalt was allowed to accumulate in solution. All related research in cobalt leaching shows that without a reducing agent, significant cobalt losses of up to 90% occur. Any cobalt losses that add to the 90% already lost in leaching are significant. This precipitation of cobalt in the copper electrowinning would also cause a decrease in the current efficiency of copper electrowinning. All these factors point to a process that would not remain viable with reduced commodity prices and reduction of the grades of mined ore.

### ***2.3.2. Pyrometallurgical Processing of Copper-Cobalt Sulphide Ores.***

As the mines become deeper in the African Copperbelt, there are copper-cobalt sulphide ores that can be profitable to exploit. During the extraction process, the ore is first concentrated by froth flotation. The flotation concentrate is then roasted in a controlled oxygen environment, allowing for the conversion of the copper and cobalt sulphides to copper and cobalt sulphates. The sulphates are then leached in acid and metal recovery continues as in oxide processing. The flowsheet for the processing of sulphide copper-cobalt ores is shown in Figure 2.2.:

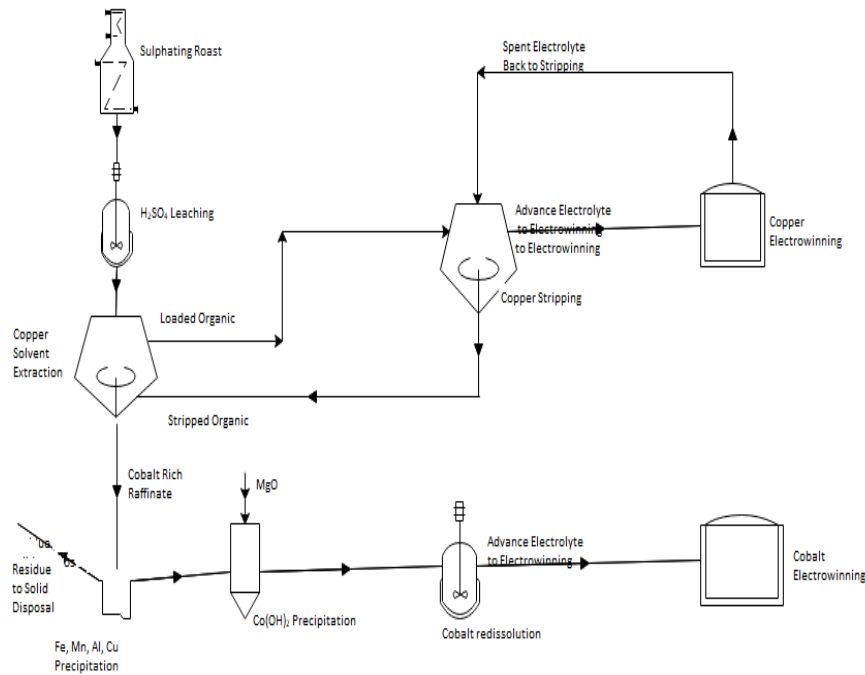

**Figure 2.2: Typical process flowsheet for copper-cobalt sulphide processing for African Copperbelt sulphide ores. (Crundwell et al., 2011)**

The sulphide ore process route in the Central African Copperbelt adds flotation and roasting to the overall process route. Flotation recovery results in about 85% copper and 60% cobalt for pure sulphide ores (Crundwell et al., 2011). When mining is performed at a depth where the ore is transitional mixed oxide and sulphide ores, recovery is about 60% copper and 40% cobalt. This means that before the losses associated with acid hydrometallurgical processing can be factored in, up to 60% of the available cobalt has already been lost to tailings (Fischer, 2011; Crundwell et al., 2011). Attempting to recover the cobalt and copper lost to tailings entails costly capital expenditure. Furthermore, the acid leaching of the calcine follows the same multi-stage precipitation route, which has risks of more cobalt losses. This means that operating costs for processing a sulphide ore are even higher because firstly, the ore is deeper in the ground meaning high mining costs. Secondly, the ore has to undergo flotation, which adds to the costs. Thirdly, the ore must undergo roasting which adds even more costs and then lastly, is the highly acid consuming hydrometallurgical process route. As a result, a possible route that reduces all or some of these costs is essential.

Currently, hydrometallurgical process routes for copper-cobalt ores are preferred to pyrometallurgical process routes because cobalt tends to slag with iron in both nickel and copper operations (Fischer, 2011). This means that up to 80% cobalt can be lost to slag when attempting to recover cobalt by pyrometallurgy (Crundwell et al., 2011; Fischer, 2011). Importantly, these high losses of cobalt to slag have led to the implementation of projects like the Chambishi cobalt from slag and copper as by-product (COSAC) project (Munnik et al., 2003) in Zambia. This project reported retrofitting cobalt from slag recovery equipment to normal processing. This is a lucrative



project because the feed material (slag) used is said to comprise 20 million tonnes of material with cobalt grade of 0.76% and copper grade of 1.2%. This material, found in slag dumps, is notably of higher grade than the material in many profitable running mines. It is fitting to argue that a fully pyrometallurgical process route in cobalt recovery only leads to high grade valuable slags and is too capital intensive to recover this lost cobalt.

## **2.4. Processing of Cobalt Occurring in Association with Nickel**

### **2.4.1. Cobalt in Nickel Laterite Ores.**

Laterite nickel ores account for about 70% of the world's nickel supply (Moskalyk, 2002). The cobalt in the limonitic layers of the nickel laterite ores is contained in goethite (Fe,Ni,Co)OOH (Crundwell et al., 2011) and in manganese wads (Georgiou and Papangelakis, 2009).

The ore material is leached in hot (250°C) sulphuric acid. Approximately 90-95% of cobalt is recovered in this leach reaction; the rest of the cobalt is lost with the residue as cobalt ferrite (CoFe<sub>2</sub>O<sub>4</sub>) (Crundwell et al., 2011) or in undissolved manganese (Georgiou and Papangelakis, 2009). The pregnant leach solution is purified by counter-current decantation and selective precipitation to give a solution containing 0.4g/L cobalt and 6g/L nickel (Crundwell et al 2011). In this leaching method, the iron is rejected as haematite but about 50-97% of the manganese in the ore is leached with the cobalt (Georgiou and Papangelakis, 2009; Guo et al., 2011; Crundwell et al., 2011).

Subsequent to leaching, the solution is precipitated by hydrogen sulphide to give sulphide precipitates. The sulphide precipitation is effected to reject the co-leached manganese. Manganese as well as most of the other impurities in cobalt-nickel production does not co-precipitate with nickel and cobalt during sulphide precipitation; it remains in solution (Crundwell et al., 2011). The sulphide precipitation technique also helps to reduce acid consumption. The recovery of cobalt from the solution to the precipitate is usually 98-99% (Crundwell et al., 2011); the rest of the cobalt is lost in the discard solution. The recovery of the cobalt from the precipitate is accomplished by leaching the cobalt in chlorine and hydrochloric acid or air and ammonia solution or oxygen and sulphuric acid to dissolve the nickel and cobalt sulphides. The metal ions are separated by solvent extraction and the resulting pregnant leach solution purified before metal recovery by either hydrogen reduction or electrowinning (Crundwell et al 2011). Electrowinning is more energy and labour intensive than hydrogen reduction (Crundwell et al., 2011). The costs of electrowinning are due to the fact that electrowinning of cobalt consumes about 3.0KWh/kg of cobalt at 400A/m<sup>2</sup> (Sharma et al. 2005) while hydrogen reduction is run at around 100-200°C (Kim et al., 2002 and Singh-Gaur, 2012).

Electrowinning is considered more labour intensive than hydrogen reduction because the cobalt has to be physically peeled from the cathode while hydrogen reduction results in fine metal powders that precipitate out of solution and can be filtered out.

The lower costs of hydrogen reduction are offset by the fact that hydrogen is not a cheap reagent to procure and the process does not recycle the hydrogen gas. In addition, the process also requires up to 4MPa (Kim et al., 2002; Singh-Gaur, 2012) of hydrogen partial pressure to effect reduction, which means that large stocks of hydrogen gas need to be stored onsite to keep the process viable. Moreover, the process also requires catalysis and added solids to act as nucleation sites for the powder precipitation of the cobalt. This means that a relatively impure product is recovered and reagent costs are high. The costs of electrowinning can be mitigated by shipping the concentrate as a solid hydroxide or sulphide offsite, where the electrowinning can be performed at sites where cheap sources of electricity are available. Furthermore, electrowinning produces acid, ensuring that the lixiviant for the advance electrolyte for electrowinning is recycled. Moreover, the electrodes are not consumed and the organic solvent is recycled so reagent costs are lower. In addition, cobalt electrowinning plant recovers a purer, more versatile and more market ready product. Hence, electrowinning is preferred over hydrogen reduction in most cobalt metal production applications as the product therefrom meets London Metal Exchange specifications.

It is easy to endorse the high-pressure acid leaching of cobalt and nickel. It rejects iron as haematite, which is stable and settles easily and can thus be filtered-out. The process leaves about 70% of the manganese in the leach solution and very little cobalt losses are reported. The metallic values are then precipitated as metallic sulphides by addition of hydrogen sulphide and then re-leached via oxidative leaching using chlorine and hydrochloric acid, air and sulphuric acid or air and ammonia. This step effectively rejects manganese while reducing acid consumption and re-extracting the nickel and cobalt (Crundwell et al., 2011).

When the oxidative leaching process is controlled, it oxidises the sulphide to either elemental sulphur or sulphate which renders cobalt and nickel precipitates soluble. Since manganese sulphide does not co-precipitate with the nickel and cobalt sulphides, the manganese remains in solution as the cobalt and nickel are precipitated and is thus rejected without excessive cobalt loss.

Significant portions of the laterite ores of nickel are destined for ferronickel smelting. There is usually no attempt to recover cobalt associated with nickel bound for ferronickel processing because the cobalt in ferronickel is not deleterious to stainless steel (Crundwell et al., 2011). Although cobalt recovery from the limonite layers of nickel laterite ores is excellent, some revenue from cobalt is lost with the nickel in ferronickel smelting. It is worth considering the application of a hydrometallurgical processing approach even for the ore destined for ferronickel processing to enable recovery and sale of cobalt for added revenue.

#### **2.4.2. Processing of Cobalt Occurring in Nickel Sulphide Ores**

Cobalt is also found associated with nickel sulphide ores. Nickel sulphide ores exist with other valuable metals like copper and platinum group metals (Warner et al., 2007). The concentration of cobalt in nickel sulphide ores ranges from 0.001-0.15% (Crundwell et al., 2011). The recovery of cobalt from nickel sulphide ores starts with the production of a flotation concentrate. The recovery of cobalt through the flotation of pentlandite ranges between 85-95% (Crundwell et al., 2011). Other researchers (Warner et al., 2007) have reported losses of nickel and cobalt when the cobalt-nickel ore exists with copper. The flotation concentrate is subsequently smelted to produce a copper-nickel-cobalt-iron matte with a low iron concentration. The recovery of cobalt in matte smelting ranges between 30-80% whilst the rest of the cobalt is lost to slag (Crundwell et al., 2011). Recovery of cobalt in nickel smelting can be as low as 20% in some smelters (Werner et al., 2007) as it tends to slag with iron (Fischer, 2011). The matte is then leached using chlorine and hydrochloric acid or air and ammonia; or oxygen and sulphuric acid. The resultant leach solution is purified by solvent extraction and selective precipitation. Metals are recovered by electrowinning or hydrogen gas reduction (Crundwell et al., 2011).

Because the matte still has iron in it, the same challenges associated with acid leaching are experienced. Before solvent extraction, the iron has to be removed by oxidation and precipitation, which leads to the co-precipitation and adsorption of cobalt thus, leading to further losses of cobalt.

Although smelting still accounts for approximately 60% of primary nickel production, the research and development in nickel and cobalt recovery seems to be moving in the direction of hydrometallurgy as opposed to smelting. (Oakley and Barcza, 2013). Generally, smelting only remains viable when ore grades are high and since high grade ores are getting mined-out and becoming more difficult to find, processing tends to be moving towards the direction of hydrometallurgy. Furthermore, as is the case in copper smelting, cobalt and even nickel losses to slag are sometimes unsustainable. Thus, the shift in processing preference for hydrometallurgy is justified. In this regard, the only pyrometallurgical technique that can be applied to enable leaching is roasting. Furthermore, the leaching solution can be ammoniacal to eliminate issues associated with acid leaching and the costs of high pressure acid leaching.

Research work on very low grade deep-sea ferromanganese nodules for recovery of cobalt and copper (and nickel) (Han et al., 1974; Niinae et al., 1994) has shown that direct ore leaching of low grade ore in ammonia, accompanied by the rejection of iron and manganese and high recovery of copper and cobalt (and nickel) is possible. It is thus fitting to investigate the viability of ammonia as a lixiviant. In addition, processes like the Caron Process (Oxley and Barcza, 2013; Crundwell et al., 2011) have shown that oxidative leaching of sulphide materials in ammonia is possible. Matte smelting results in a reduced mass for leaching but matte smelting also results in high cobalt losses (Crundwell et al., 2011; Fischer, 2011; Munnik et al., 2003). The high cost of

increased volume of lixiviant required can be mitigated by the high recovery of valuable metals.

## 2.5. Traditional Processing of Copper Ores

The technology for the processing of copper is old and well-established. 80% of produced copper is treated by pyrometallurgy (Davenport et al., 2002; Schlesinger et al., 2011). Copper sulphide ores containing minerals like chalcopyrite ( $\text{CuFeS}_2$ ), chalcocite ( $\text{Cu}_2\text{S}$ ), covellite ( $\text{CuS}$ ) and digenite ( $\text{Cu}_5\text{S}_9$ ) are concentrated by froth flotation, where the copper grade is improved from about 0.5-2% copper to about 25-50% copper (Moore, 1990). The flotation concentrate is partially roasted to ensure that all the copper in the concentrate exists as  $\text{Cu}_2\text{S}$  and to reduce the sulphur content. The roast is smelted to produce a matte containing copper sulphide and iron sulphide ( $\text{Cu}_2\text{S-FeS}$ ). The matte is subsequently transferred to a converter where the copper is converted to blister copper (98% copper) and the iron reacts with acidic products to form slag. The blister copper is further refined by fire resulting in a product containing 99.5% copper (Moore, 1990). Since the reaction of iron sulphide to form iron oxide is exothermic, the smelting of copper can be economically viable as after initial reaction, the process becomes self-sustaining.

For application in electric and electronic components, the copper needs to have 20ppm impurities or 99.999% purity. This is achieved by electro-refining. According to Davenport et al (2002), the fire refined copper is cast into anodes and fed into an electro-refining circuit. In electro-refining, the cast anodes are re-dissolved in sulphuric acid. The copper deposits on the cathode as high purity market-ready copper whilst base metal impurities like arsenic, bismuth, cobalt, iron, nickel and antimony remain in solution and noble metals like silver, gold and platinum sink to the bottom of the electro-refining vessel as slimes to be collected. The collected slimes are treated to recover the valuable metals (Davenport et al., 2002 and Schlesinger et al., 2011).

In the processes of matte smelting and matte conversion, cumulative copper to slag losses of between 5% and 25% occur. (Moore, 1990; Davenport et al., 2002) It can also be speculated that even higher amounts of cobalt associated with the ore are also lost to slag as cobalt tends to slag with iron (Fischer, 2011). If conservative estimates of cobalt losses in copper smelting are as high as in nickel smelting, it then means that cobalt losses can be as high as 75%. This therefore highlights a need for a hydrometallurgical process route that loses less cobalt or a flexible plant capable of treating slag like the Chambishi plant in Zambia (Munnik et al., 2003).

Copper is also recovered through a hydrometallurgical processing route. The hydrometallurgical processing route for copper production entails crushing, grinding, leaching in acid, solvent extraction and electrowinning. The generic flow-sheet for hydrometallurgical processing of copper is shown in Figure 2.3.

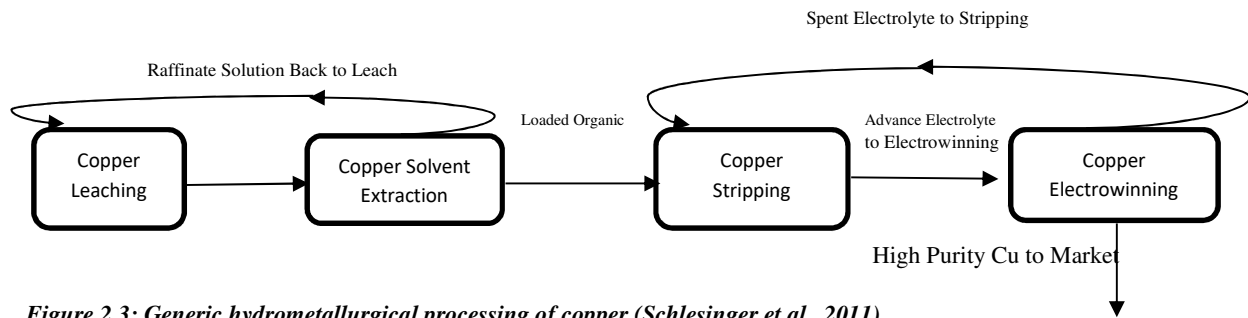

Figure 2.3: Generic hydrometallurgical processing of copper (Schlesinger et al., 2011)

It should be noted that the flow-sheet in figure 2.3 above is an overly simplified version which does not show the fact that copper always exists with other valuable metals like zinc, lead, cobalt and nickel. This means that the raffinate solution from solvent extraction is not recycled back to leaching as shown above, but is probably a cobalt and/or nickel and/or zinc rich pregnant leach solution which will undergo neutralisation to purify the valuable metallic ions for electrowinning or saleable intermediates. This indicates that the acid balance is not as clear-cut. Acid consumption is much higher because the acid is consumed and neutralised; the next leach-SX-EW cycle requires fresh acid not recycled acid.

## 2.6. Alternative Hydrometallurgical Processing Techniques

### 2.6.1. Overview

Having discussed the traditional leaching techniques and having considered their merits and demerits, it is fitting to discuss leaching techniques that are alternatives or modifications of the current common industrial practice. They can either be in acidic or in basic media. A study of the traditional processing techniques of copper and cobalt show cobalt losses in acid leaching and very high cobalt losses in smelting. It is thus clear that there needs to be an improved processing technique capable of high recovery of copper and cobalt, high rejection of iron, manganese and other impurity metals as well as an ability of the leach solution to be recycled after a cycle of leach-SX-EW. There are two methods that have been the subject of research and test work. These are broadly based on modifying the present sulphuric acid leaching route by using alternate reducing agents or using alternative lixivants in the overall process.

### 2.6.2. Leaching of Copper-Cobalt Bearing Ore Material in Ammoniacal Solution

The use of ammoniacal leaching solution in the processing of copper-cobalt oxide ores is the subject matter of this research work. In basic ammonia-ammonium salt solutions, iron and manganese exist predominantly as practically insoluble oxides and hydroxides at pH 8.5-11, while copper and cobalt (and nickel) form stable ammine complexes in the presence of excess ammonia (Welham et al., 2015).

When considering the Pourbaix diagrams in Figure 2.4 below, it can be seen that at pH between 8.5 and 10 and at a potential of 0.0-1.0V, soluble copper and cobalt

ammine complexes will form while the oxides and hydroxides of iron and manganese that are not as stable in aqueous solution, are more favoured.

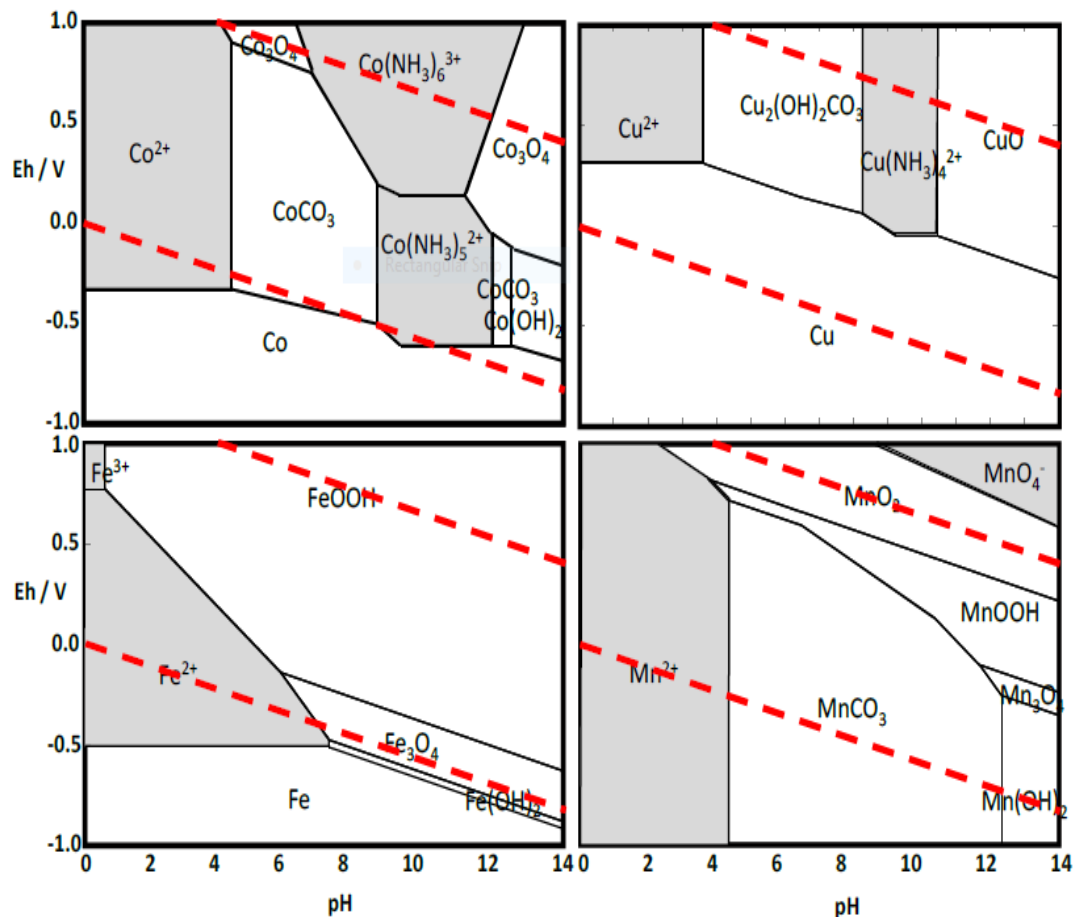

Figure 2.4:  $\text{Cu-NH}_3\text{-(NH}_4)_2\text{CO}_3$ ;  $\text{Co-NH}_3\text{-(NH}_4)_2\text{CO}_3$ ;  $\text{Fe-NH}_3\text{-(NH}_4)_2\text{CO}_3$  and  $\text{Mn-NH}_3\text{-(NH}_4)_2\text{CO}_3$  Pourbaix Diagrams. (Welham et al., 2015)

Further benefits of leaching the ore using ammonia include the fact that since there are very low concentrations of co-leached gangue metals, there is no downstream requirement to perform multi-stage precipitation of gangue metals. Furthermore, since the gangue is solid, there is no requirement to bleed the leach solution because there is no accumulation of ions in solution. In addition, because the discarded solids remain pretty much in the state they were in while in the ore, there are no environmental problems associated with waste disposal as no soluble species are discarded in the waste. Moreover, the residual ammonia in the waste is easily oxidised in air to become fertiliser in soil, thereby eliminating the need to monitor acid in tailings (Welham et al., 2015). The leached metals can be removed by solvent extraction with no threat of cobalt extractant contamination by iron. Furthermore, the residue can be easily allowed to settle and be easily filtered-out afterwards. This means that the ammonia leach solution can be easily recovered without significant replenishing; a feat not so easily achievable in acid leaching of a mixed ore.

There are unavoidable issues in acid leaching that can be theoretically by-passed in ammonia leaching. These include the fact that in the event that the ore is hosted in dolomite ( $\text{CaCO}_3 \cdot \text{MgCO}_3$ ) gangue, a significant amount of the acid will be consumed by the carbonate in the gangue. Furthermore, there will be generation of gypsum ( $\text{CaSO}_4 \cdot 2\text{H}_2\text{O}$ ), which is difficult to filter. In addition, in every cycle of the hydrometallurgical processing route from leaching to final product recovery, the acid is effectively neutralised (up to pH 8.8) (Crundwell et al., 2011 and Fischer, 2011) to effect the required multi-stage selective precipitation of the impurity metals and to effect cobalt hydroxide precipitation. This clarifies that as an operational requirement, there needs to be large stocks of acid available. Lastly, using magnesium oxide to precipitate cobalt out of the acid solution is not very efficient. There is an irreducible amount of about 1g/L of cobalt recirculating in the acid leaching solution (Welham et al., 2015) after cobalt precipitation. The alternative flowsheet proposed is shown in Figure 2.5:

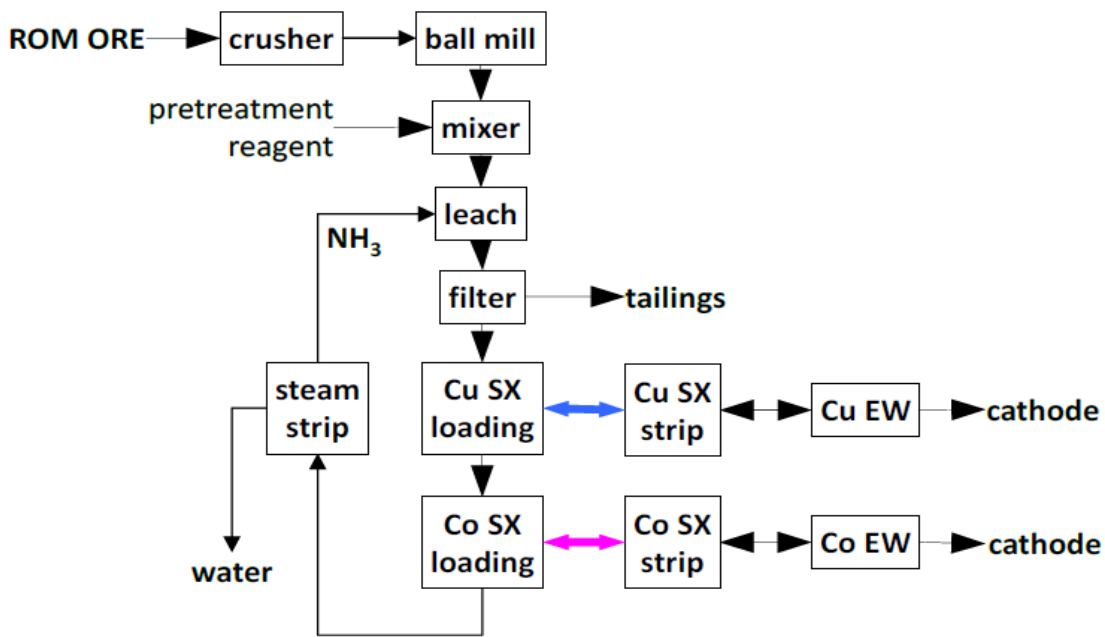

Figure 2.5: Proposed Flowsheet for Ammonia Leaching. (Welham et al., 2015)

With knowledge of the associations and dissemination of the components of the valuable material in the ore relative to the gangue, an appropriate pre-treatment solution can be selected to ensure high recovery of copper and cobalt as well as high rejection of impurity metals. This means that the gangue metallic values are rejected early in the process. If however, the valuable components of the ore are chemically linked to the gangue components as cobalt in manganese wads then the manganese must be rendered soluble to liberate the cobalt. The manganese precipitates later because the manganese ammine is relatively unstable. In addition, copper solvent extraction is more efficient in basic (Welham et al., 2015) than in acid solutions and

hence, with stringent process monitoring, it is possible to have no significant copper in the cobalt PLS.

Good knowledge of the associations and disseminations of the copper and cobalt bearing minerals can determine the required reagents for leaching and purification. Figure 2.4 shows that at their highest oxidation states, copper and cobalt ammine complexes are stable in solution whilst iron and manganese are insoluble in the working regions of 0.0-1.0 V redox potentials and pH 8.5-11. Theoretically, this means that iron and manganese can be rejected from aqueous solution by maintaining an oxidising environment in the leach liquor. However, research (Welham et al., 2015; Vu et al., 1980 and Fischer, 2011) has established that leaching of cobalt requires use of a reducing agent both in acid leaching and ammonia leaching. In acid leaching, the reducing agent is required to firstly liberate the cobalt intimately associated with manganese wads and iron minerals in the ore, and to further convert the cobalt from trivalent practically insoluble cobalt to divalent soluble cobalt. In acid leaching, cobalt has to be strictly in its divalent form. However, when the cobalt is complexed in ammonia, the trivalent form is still soluble. This is due to the fact that the trivalent cobalt ammine complex ( $\text{Co}(\text{NH}_3)_6^{3+}$ ) is stable in aqueous solution. That notwithstanding, reported empirical data (Vu et al., 1980; Welham et al. 2015) revealed that a reducing agent is still required to leach cobalt from its ore in ammonia. This is because the trivalent cobalt ammine complex forms slowly and also because cobalt exists in its ores intimately associated with manganese wads and iron-bearing minerals. Notably, Vu et al. (1980) did some work to test the hypothesis. The premise of the project was that because the species  $\text{Co}(\text{NH}_3)_6^{3+}$  is stable in aqueous solution at pH 8.5-10, it should be possible to leach cobalt without the use of a reducing agent or a reduction roast step. However, results from the test work undertaken showed that direct leaching of the ore without reduction was not economically feasible. This conclusion was the same for both acid leaching and alkaline leaching with ammonia. Thus, a step that effects reduction is required when the leaching of cobalt is performed.

Thermodynamic data presented in Table 2.1 and Figure 2.4 show that  $\text{Co}(\text{NH}_3)_6^{3+}$  and  $\text{Cu}(\text{NH}_3)_4^{2+}$  are stable in aqueous solution at pH 8.5-10. This premise can still be used to ensure a pure pregnant leach solution when undertaking ammonia leaching. It should be highlighted that the currently applied oxidation technique of using a mixture of sulphur dioxide and air (Ferron, 2008 and Crundwell et al., 2011) can be used to keep iron and manganese in their more insoluble trivalent and tetravalent states at basic pH. Further work investigating the dominant species existing at different potential values has been reported in research (Achadrya and Das, 1987). This work was aimed at controlling the rejection of manganese and iron from copper-cobalt-nickel ammonia leaching. The values are shown in Table 2.1.





The reaction then proceeds further to:

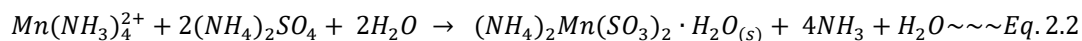

Han et al (1974) reported similar observations in their work and suggested that the initial dissolution is due to the formation of manganese (II) sulphate when manganese (IV) oxide is reacted with ammonium thiosulphate. The subsequent precipitation was attributed to the formation of the insoluble manganese (II) hydroxide at basic pH which is more stable than the corresponding manganese ammine. The reactions are shown in equation 2.3 and 2.4:

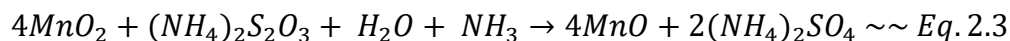

The reaction carries on in such a way:

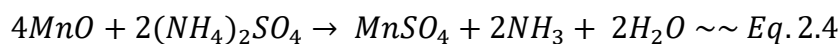

The precipitation reaction occurs as illustrated in Equation 2.5:

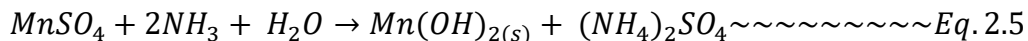

The observations show that when the ore is pre-treated with a reducing agent the manganese will dissolve with the cobalt and the copper. The manganese then precipitates as the oxide, hydroxide or the insoluble species postulated by Niinae et al., (1994). This means that the gangue problem in the form of iron and manganese sorts itself out in ammonia leaching even without the incorporation of a designated purification step. It can thus be concluded that soluble manganese species is formed after reduction and that an insoluble species then forms and precipitates out when exposed to ammonia.

A middle-ground argument has however been made in the work of Das et al, (1986). The argument suggests that subsequent to reduction, soluble manganese ammine species form, which precipitate as manganese (II) hydroxide due to the effect of pH. This was found to follow the equation:

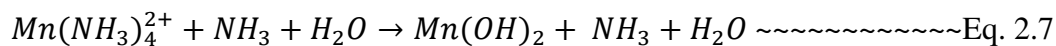
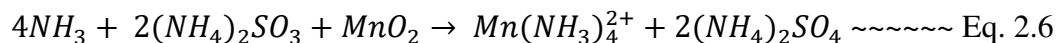

While still investigating and optimising leaching of copper, cobalt and nickel in ammoniacal solutions, glucose was investigated as a possible reducing agent when leaching copper, cobalt and nickel from deep-sea manganese nodules (Das et al., 1986). It was found that about 90% of the copper; 90% of the nickel and only 60% of the cobalt in the deep-sea manganese nodule ore material could be leached with ammonia-ammonium chloride solution and glucose as a reducing agent. The work further found that glucose is only effective as a reducing agent at pH 10 or below. Das et al., (1986) claimed that above pH 10, glucose reacts to form an unreported non-reducing species. No chemical reaction or chemical species was postulated and the

entire argument appeared to be speculation. A factor that Das et al. (1986) did not explore is the relative stability of copper and cobalt (and nickel) ammine complexes beyond pH 10 relative to their respective hydroxides and oxides. This argument seems more likely than a reaction of glucose to non-reducing species.

Another reduction approach investigated was the direct ore reductive roasting (Han et al., 1974) on deep-sea ferro-manganese nodules. This route of leaching was found to be able to recover 80% copper and 80% nickel but failed to recover more than 50% of cobalt. It is unclear how much time the roasted sample was in air prior to leaching and if any analysis was performed to ascertain if the ore had not been re-oxidised, even partially, between roasting and leaching. Roasting is also a costly energy-consuming process requiring burning of fossil fuels and stringent capital-intensive controls to mitigate environmental emissions. To avoid the high costs of roasting and because the process route seems to fail to extract economically sufficient cobalt from the ore (Han et al., 1974), a reductive roasting step is not preferred for this work.

An additional reducing agent investigated was manganous ( $Mn^{2+}$ ) ions (Achadrya and Das, 1987). This process was to be coupled with stringent potential and pH control to ensure sufficient rejection of manganese and iron downstream. The work only reports that with control of pH and potential, iron and manganese can be rejected in the pregnant leach solution. The discussion does not propose a practical way to control the potential between 0.25V and 1.0V or even show attempts to monitor or control potential in the experimental work. This means that it could be difficult to justify deliberately increasing the concentration of manganese in the leaching of copper and cobalt especially since at manganese concentration favouring 90% cobalt extraction into solution, there was a resultant 30% extraction of manganese into solution. Furthermore, the ore material that was used for the work was deep-ocean ferro-manganese nodules with 13% manganese and 0.112% cobalt. This meant that if 30% of the manganese in the ore material went into solution with 90% of the cobalt therefrom, the pregnant leach solution would be more concentrated in manganese than in cobalt by at least one order of magnitude, which cannot in anyway be called a rejection of manganese. Using manganous ions in industry may prove challenging and not very cheap. It would demand a cheap source of manganese, although the reducing agent may be recyclable, which would offset the cost of purchasing analytical reagents. This might not be as straightforward and easy as it sounds. Firstly, it is impossible to calculate the reducing agent requirement as the dissolution of cobalt in this ore may involve liberation of the cobalt from goethite and manganese wads, which means that manganese and iron must also be reduced. This can be rectified with laboratory test work but, when there is a high concentration of iron and manganese there are high possibilities to co-precipitate cobalt as the gangue metallic values are rejected (Welham et al., 2015; Feurstenau and Osseo-Assare, 1987 and Dyer et al., 2012).

It can then be argued that of the reducing agents worth suggesting for this work, ferrous ions and manganous ions are not recommended because they increase the

concentration of gangue metallic values in the matrix and thus, increase the problem of cobalt co-precipitation by adsorption on the gangue. The second group of reducing agents is sodium metabisulphite, sodium sulphite and sodium thiosulphate. These already enjoy use in this industry but necessitate bleeding of the leach liquor to remove the sodium. Moreover, they are fairly costly when compared to ferrous ions which can be made onsite from scrap iron around the plant (Welham et al., 2015). However, sodium metabisulphite, sodium sulphite and sodium thiosulphate are more effective and do not come with possible adsorption losses, so the excess costs can be justified if they result in the valuable cobalt being available for market. The third group of reducing agents that can be used in this work are ammonium sulphite and ammonium thiosulphate. Although ammonium thiosulphate was found to be a good reducing agent it increased manganese extraction (Niinae et al., 1994). This could be due to the fact that the thiosulphate is divalent and can be oxidised to tetravalent ( $\text{SO}_3^{2-}$ ;  $\text{S}_2\text{O}_5^{2-}$ ), and hexavalent ( $\text{SO}_4^{2-}$ ) species. Thus, of the two reducing agents ammonium sulphite is preferred to control the amount of dissolved manganese (Niinae et al., 1994). These ammonium compound reducing agents however, have the problem of being sold as aqueous solutions and their being liquid adds difficulty in their transporting unlike the sodium sulphur salts which are transported as solids. Despite being quite costly, they however, do not need to be bled out of solution because they increase the ammonia-ammonium salt concentration.

The last reducing agent for consideration is sulphur dioxide. Sulphur dioxide would seem to be the best choice for the current market. The raw material for sulphur dioxide is sulphur. Sulphur is currently very cheap when procured from the petroleum industry where it is a waste product. Sulphur is moved around as solid sulphur, which makes transportation easy. Furthermore, at the plant, sulphur dioxide can be moved around as aqueous sulphur dioxide. In addition, there is a perfected use of an air-sulphur dioxide mixture to use as an oxidising agent for the full rejection of iron and manganese. Lastly, aqueous sulphur dioxide or sulphurous acid can effect acidolysis on the ore as a pre-treatment step which can be proposed as an improvement of a technique styled sulphuric acid acidolysis and water leaching (Xu et al., 2005). The technique styled sulphuric acid acidolysis and water leaching (SAWL) proceeds this way; the ore is pre-treated by soaking in 98% (v/v) sulphuric acid for four days. After four days the ore is leached by percolating leaching with water. It has been reported that copper, cobalt and nickel extraction of over 80% while iron and manganese extraction of over 70% could be attained into solution (Xu et al., 2005). A method of soaking the ore in acidic reducing agent and then leaching in ammonia-ammonium salt has also been performed and was reported to yield 90% copper extraction and almost 100% cobalt extraction (Welham et al., 2015). In the method, hydrochloric acid and sodium sulphite were mixed to make an acidic reducing agent of sodium sulphite at pH 2.

Since it is an acid with a tetravalent sulphur species, aqueous sulphur dioxide can fulfil both the roles of the hydrochloric acid and the sodium sulphite. The downsides of

sulphur dioxide as a reducing agent are that it cannot be used in heap leaching arrangements because sulphur dioxide cannot be released into the atmosphere. Sulphur dioxide has also been reported (Ferron, 2008; Mwema et al. 2002) to reduce copper extraction due to two possible reactions. Either the copper is reduced to metallic copper which does not leach as easily as copper oxide or the copper precipitates as a mixture of copper sulphites ( $\text{CuSO}_3 \cdot \text{Cu}_2\text{SO}_3 \cdot 2\text{H}_2\text{O}$ ). In fact, one of the researchers who investigated sulphur dioxide as a reductant (Ferron, 2008) did not recommend sulphur dioxide as the primary reducing agent in copper-cobalt leaching because of the high copper losses associated with the reagent. Instead, it was recommended that the primary reducing agent be ferrous ions and that sulphur dioxide be used as the secondary reducing agent to regenerate the ferrous ions for subsequent leaching. Since other researchers (Dyer et al., 2012; Feurstenau and Osseo-Asare, 1987) have reported that as a general rule, high concentration of iron leads to cobalt adsorption losses, any activity that increases the concentration of iron is disavowed in this current research work.

Therefore, in this test work, ammonium sulphite will be used as a reducing agent. The reasons are that it is easy to handle and that it has been deemed (Niinae et al., 1994) to be better than ammonium thiosulphate at rejecting manganese from solution. In addition, there are no reports linking ammonium sulphite reduced copper extraction. Ammonium sulphite also adds to the total ammonia/ammonium ion concentration in the leaching solution and as such can improve the metal extraction efficiency. However, this claim has not been verified in research. There are two reports cited that used sodium sulphite (Welham et al., 2015) and ammonium sulphite (Niinae et al., 1994) and both have reported high extractions of copper and cobalt. Ammonium sulphite was also selected in this work because it does not add sodium to the environment.

## **2.7. Cobalt Losses Associated with Ammoniacal Leaching**

Dyer et al (2012) investigated cobalt loss due to adsorption of cobalt on iron precipitates. They indicated that the precipitating iron species during the ammoniacal leaching of cobalt and nickel was ferrihydrite ( $\text{Fe}_2\text{O}_3 \cdot 9\text{H}_2\text{O}$ ), which they argued had a very large surface area for adsorption when compared to iron (III) hydroxide ( $\text{Fe}(\text{OH})_3$ ) and haematite ( $\text{Fe}_2\text{O}_3$ ). This, they suggested, meant that the problem of cobalt loss due to adsorption on iron species was a bigger problem than initially believed. In their work, they found that cobalt loss increased when the concentration of co-leached iron increased. As a result, it is essential to ensure that iron and manganese are not co-leached to avoid cobalt losses to the residue. Possible process control could mean ensuring that leaching is carried out in the vicinity of pH 10 to avoid co-leaching of manganese and iron as their subsequent precipitation leads to unacceptable cobalt losses.

Further research on the adsorption of copper and cobalt on solid substrates (Feurstenau and Osseo-Asare, 1987) found that copper and cobalt (and nickel) tended to be lost by adsorption on solid substrates at the pH of their hydrolysis. It was reported that copper adsorption increased with a rise in pH, between 4 up to pH 7 where it started to decrease until a pH of about 9.3 then it started to increase again. It was reported that cobalt and nickel adsorption increased with an increase in pH until pH 8.5 where the increase would peak and start to decrease until a minimum at a pH of 9.3 where the adsorption would start to increase again. These observations were attributed to several phenomena. It was argued that the points where the adsorption peaked were the pH points of hydrolysis of that particular metal. It was further concluded that in general, the larger the surface area of the residue solids, the higher the adsorption of copper, cobalt and nickel.

It is further reported that in adsorption phenomena the species  $\text{Co}(\text{NH}_3)_6^{3+}$  is not specifically adsorbed on solid species (Stumm et al., 1968 cited in Feurstenau and Osseo-Asare, 1987). The work (Feurstenau and Osseo-Asare, 1987) investigated the effect of concentration of ammonia solution, the effect of the solid substrate (the substrates were haematite, titania, alumina and silica but curiously no manganese dioxide); surface properties of the solid substrates. The work also studied kinetics of the adsorption and developed a kinetic model for this adsorption. It was shown (Feurstenau and Osseo-Asare, 1987) that adsorption increased as pH increased between pH 4 and 8.5 because at that pH, ammine complexes are not stable while oxides and hydroxides are more predominant. This argument can be further confirmed by looking at the Pourbaix Diagrams. At pH 9.3 where minima of adsorption or minimum metallic loss is observed, this is where the most predominant species are the ammine complexes, which have been observed to not adsorb on these solid substrates. Beyond pH 9.5 there is ligand competition between the ammine complexes and the hydroxyl complexes. These hydroxides are unstable in solution and tend to precipitate and adsorb on solid substrates as observed by Dyer et al., (2012). The work by Dyer et al (2012) confirmed that the predominant species detected by XRD at the peak adsorption of copper, cobalt and nickel were the hydroxides and the aqua complexes of these metals. From the findings of these researchers (Feurstenau and Osseo-Asare, 1987; Dyer et al., 2012; Osseo-Asare et al., 1983) it can be concluded that the cobalt ammine complex does not adsorb on the precipitate. This means that at a pH where the cobalt ammine complex is predominant, minimum cobalt loss is reported. This was found to be between pH 9.3-10. At a pH more acidic than pH 9.3 the low solubility oxides and carbonates (when the ammonium salt used is ammonium carbonate) are more predominant and lead to observed cobalt losses. At a pH more basic than pH 10 there is a predominance battle between the ammine complex and the hydroxide. As such at pH 9.3-10 or  $\frac{[\text{ammonia}]}{[\text{ammonium salt}]}$  ratio between 1 and 10, there should be minimum cobalt losses.

The work investigating the adsorption of copper and cobalt on solid substrates (Feurstenau and Osseo-Asare, 1987) confirms that the information on Pourbaix

Diagrams (See Figure 2.4) can be used to design leaching conditions. The work was however, performed on pre-formed solid substrates and not on solids forming from the solution.

This makes findings of the work (Feurstenau and Osseo-Asare, 1987) difficult to use to predict the behaviour of cobalt and copper when the valuable metals exist in an ore body. This is because of the other metals and elements that make-up the ore matrix. However, it is still fitting to argue that when leaching is carried out at pH 9.3-10, loss of cobalt to residue can be reduced (Feurstenau and Osseo-Asare, 1987). This can be achieved by manipulating the concentration of the ammonia and ammonium salt. Manipulation of the pH of the leach solution can be effected by utilising the equation as cited in Das et al. (1986).

$$pH = 9.26 + \log \frac{[NH_3]}{[NH_4^+]} \text{ Eq. 2.8}$$

Thus, by managing the ratio of concentrations of the ammonia solution relative to the ammonium salt, it is theoretically possible to work at a pH that favours minimal valuable losses.

While Fuerstenau and Osseo-Asare (1987) were studying adsorption on pre-formed substrates, Dyer et al., (2012) took it a step further and studied the loss of cobalt in a solution where the precipitate is forming as the cobalt is being leached. This study is more relevant to this test work than adsorption on pre-formed substrates. It was reported that from a weakly acidic pH of about pH 5, the adsorption loss of cobalt increased with a rise in pH up to about pH 7 where the adsorption started to decrease until about pH 10, where minimum loss was observed. The argument is that at the weakly acidic pH, cobalt undergoes hydrolysis and the species  $Co(NH_3)_x(H_2O)_{(6-x)}^{3+}$  competes with the hexamine complex,  $Co(NH_3)_6^{3+}$ . At a pH where minimum cobalt is lost to adsorption, the predominant species is the hexamine cobalt complex, which does not adsorb on the precipitate. It is then feasible to deduce that at the pH of peak cobalt adsorption, the predominant species is the hexaaqua complex only, which translates to the hydroxide or the oxide. The addition of excess ammonia which allows the  $\frac{[NH_3]}{[NH_4^+]}$  ratio to generate a solution environment with a pH range between 9.3 and 10.5 is thus expected to theoretically minimise cobalt losses to adsorption on precipitates.

### Summary

From the literature studied, it can be learned that leaching of copper from the copper-cobalt oxide ore does not pose valuable loss problems (Welham et al., 2015; Das et al., 1986; Niinae et al., 1994). In all instances of leaching copper and cobalt in acid or basic ammonia >80% copper extraction has been reported. Furthermore, all the problems listed in the problem statement such as high acid consumption and unacceptable valuable losses are not due to copper. This is because of the solvent

extraction step that enables the extraction of the copper out of solution leaving the leach liquor sufficiently acidic to be recycled. The reason the acid cannot be recycled is because of the subsequent processing of cobalt. Most arguments pertaining to the consideration of this method are thus, based on improvements in the extraction of cobalt.

Literature (Das et al., 1986; Vu et al., 1980; Welham et al., 2015) reveals that all investigations of hydrometallurgical extraction of copper and cobalt in basic ammine leaching require the use of a reducing agent. This is regardless of the fact that the ammine complexes of copper and cobalt are stable at their highest oxidation states. It can be postulated that this is because the valuable metallic species of cobalt need to be released from the respectively tetravalent and trivalent manganese and iron wads in the ore and because formation of the trivalent cobalt ammine complex happens slowly.

The reducing agents that can be used are ferrous ions, manganous ions, sodium or ammonium sulphite, metabisulphite or thiosulphate. Research has shown that manganous and ferrous ions are unfavourable as reduction agents in spite of their low cost because they add impurities to the matrix that increase the probability of cobalt loss; a problem this work is trying to eliminate. Sodium-oxy-sulphur compounds are good reducing agents but add sodium into the leach liquor which has to be bled out. They however, have the advantage of being able to be transported as solids so they are worth considering as reducing agents in the process. In spite of this, sodium oxy-sulphur compounds are used extensively in industry and although they are more expensive than ferrous ions, they are still a good value proposition. Ammonium sulphite is also worth considering as a reducing agent. It is sold as an aqueous solution and is expensive; it also may not be very suitable for large scale use because of the costs but has been found to be good at rejecting manganese (Niinae et al., 1994) out of the leach liquor. It is also able to regulate the  $\frac{[NH_3]}{[NH_4^+]}$  ratio that regulates the leaching pH. Unlike sulphur dioxide, it has not been reported to lead to unwanted copper losses and as such was used in the current test work.

If it was not for the fact that it results in undesirable copper loss, the best reducing agent in a closed leaching set up would be sulphur dioxide. The raw material for its manufacture is cheap to purchase and cheap to store. The aqueous solution of sulphur dioxide can be moved around the plant easily as aqueous sulphur dioxide. It can also possibly improve on a method that found positive results in research (Xu et al., 2005). While aqueous sulphur dioxide sounds like a cheap favourable reducing agent, it is not recommended for use because it has been reported (Ferron, 2008; Mwema et al., 2002) to lead to high copper losses. Researchers (Ferron, 2008) who investigated sulphur dioxide as a reducing agent recommended sulphur dioxide as a secondary reducing agent and not the primary reducing agent. It was recommended that divalent iron solution be the primary reducing agent in leaching and aqueous sulphur dioxide as the secondary reducing agent to regenerate the ferrous ions after leaching (Ferron, 2008). Another team of researchers (Mwema et al., 2002) who investigated the use of



sulphur dioxide as a reducing agent reported only 10-13% copper extraction when using aqueous sulphur dioxide as reducing agent. Therefore, sulphur dioxide was not considered as a reducing agent for use in this work in spite of its other attractive attributes. Since this project does not favour using ferrous and manganous ions as reducing agents, ammonium sulphite and/or sodium metabisulphite were preferred as the primary reducing agents.

To prevent cobalt loss by adsorption on the residue, it is necessary to restrict the leaching to between pH 9.3 and 10 where ammine complexes are predominant. In this pH range there is reduced ligand competition from oxides and hydroxides. From literature, one can also learn the potentials at which manganese and iron can be rejected as insoluble oxides and hydroxides from leach solution. Hence by monitoring and controlling pH and potential, using the concentration ratio of  $\frac{[NH_3]}{[NH_4^+]}$  and air, a minimum of cobalt loss and a maximum of ferro-manganese rejection can be theoretically achieved.

# Chapter 3

## Materials and Methods

### 3.1. Overview

The ore material used in the study is an oxidised copper-cobalt ore from a plant in the Katanga region of the Democratic Republic of Congo in the Central African Copperbelt. The ore arrived in granular form with a wide particle size distribution.

The ore was milled and screened to four different size fractions. These were -150+90 $\mu\text{m}$ ; -75+63 $\mu\text{m}$ ; -53+45 $\mu\text{m}$  and -38 $\mu\text{m}$ . The +75-90 $\mu\text{m}$  material was incorporated into the -150 $\mu\text{m}$ , the +53-63 $\mu\text{m}$  formed part of the -75 $\mu\text{m}$  material, and the +38-45 $\mu\text{m}$  was incorporated into the -53 $\mu\text{m}$  material. Samples from these four size fractions were sent for quantitative elemental analysis by x-ray fluorescence (XRF). Mineral phase analysis was previously performed by x-ray diffraction (XRD) (Kyembo, 2015). Kyembo (2015) worked on the same ore material.

### 3.2. Ore Preparation and Characterisation

The ore was pulverised with a laboratory pulveriser and then screened to four size classes. These were -150+90 $\mu\text{m}$  (called -150 $\mu\text{m}$  for ease of reference); -75+63 $\mu\text{m}$  (called -75 $\mu\text{m}$  for ease of reference); -53+45  $\mu\text{m}$  (called -53  $\mu\text{m}$  for ease of reference) and -38  $\mu\text{m}$ . The -75 $\mu\text{m}$  size fraction was preferred because it was found to have the highest-grade size fraction of the ore for copper and cobalt (See Table 4.1(a)).

### 3.3. Reagent Preparation

*Ammonia solution:* 1200ml of 30-33% Ammonia Solution stock solution was diluted with deionised water to make 5.0L of 4.0M ammonia solution. From this stock solution, 125ml of the 4.0M ammonia solution was diluted with deionised to make 0.5M solution, 250ml of the 4.0M solution was diluted with deionised water to make 1L of 1.0M ammonia solution. 500ml of the 4.0M stock solution was diluted in deionised water to make 1L of 2.0M ammonia solution.

*Ammonium Carbonate Solution:* 769 g of solid ammonium carbonate was dissolved in deionised water to form a stock concentration 2L of 4.0M ammonium carbonate solution. From this stock solution, 12.5ml of the 4.0M solution was diluted in deionised water to make 500ml of 0.1M ammonium carbonate solution. 25ml of the 4.0M solution was diluted in deionised water to make 500ml of 0.2M ammonium carbonate solution. 200ml of the 4.0M solution diluted with deionised water to make 2l of 0.4M ammonium carbonate solution. 62.5 ml of the 4.0M ammonium carbonate solution was diluted with deionised water to make 250ml of 1.0M ammonium

carbonate solution. 125ml of 4.0M ammonium carbonate solution was further diluted to make 250mL of 2.0M ammonium carbonate solution.

*Ammonium Sulphite Solution:* 1367ml of 34% ammonium sulphite solution stock solution was diluted with deionised water to make 2L of 2.0M ammonium sulphite solution. From this solution 25ml of the 2.0M solution was diluted with deionised water to form 250ml of 0.2M ammonium sulphite solution. 200ml of the 2.0M solution was diluted with deionised water to form 1000ml of 0.4M ammonium sulphite solution. 75ml of the 2.0M solution was diluted with deionised water to form 250ml of 0.6M ammonium sulphite solution. 100ml of 2.0M ammonium sulphite solution was diluted with deionised water to form 250ml of 0.8M ammonium solution. 125ml of 2.0M ammonium sulphite solution was diluted with deionised water to form 250ml of 1.0M ammonium sulphite solution.

### 3.4. Experimental Equipment

Experiments were carried out in 250ml Pyrex sealable glass liquid sample container bottles. The bottles were attached to sample holder units in a heated shaking water bath with adjustable temperature. Samples were collected by pipetting using a calibrated glass pipette and filtered with a filter paper into a volumetric flask before dilution. The explanation is illustrated in Figure 3.1.

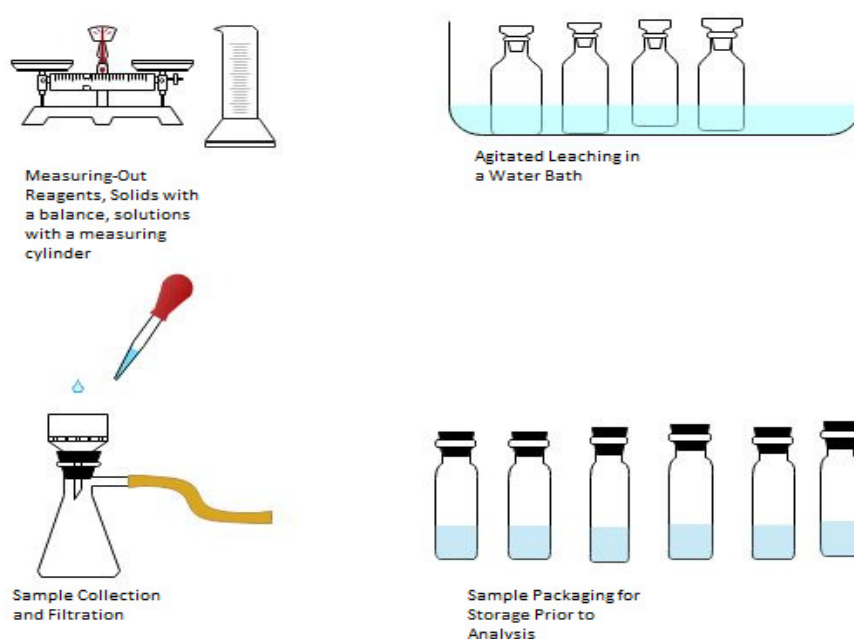

**Figure 3.1: Equipment Schematic Showing that Reagents were measured-out, Leached in a sealed glass vessel, filtered and collected in a labelled container for analysis.**

### 3.5. Experimental Procedure

#### 3.5.1. The Effect of the Concentration of Ammonium Sulphite (Reducing Agent) Solution on Leaching

Thermodynamic data in literature as illustrated in Figure 2.4 and in Table 2.1 show that the species  $\text{Cu}(\text{NH}_3)_4^{2+}$  and  $\text{Co}(\text{NH}_3)_6^{3+}$  which are ammine complexes of copper and cobalt in their highest oxidation states, are stable in solution as ammine complexes at pH 8.5-11. The higher oxidation states of iron and manganese do not form ammine complexes as illustrated in Figure 2.4 and as shown in Table 2.1. This means that they are not stable in solution at basic pH. Theoretically, this means that there is no need to leach the ore via reductive leaching. This also points to the fact that if a reducing agent is not required for leaching this ore, theoretically iron and manganese can be kept permanently out of solution by using an oxidising rather than a reducing agent. It is however, also possible that part or all the cobalt is intimately and chemically associated with an iron mineral like goethite or exists with a manganese wad which would mean that reduction of the manganese and/or iron is required to liberate the cobalt and enable the cobalt to react with the ammonia.

The first investigation was to determine the need to perform reductive leaching. This was performed by comparing leaching extraction efficiencies in the absence and in the presence of different concentrations of the reducing agent (ammonium sulphite). The matrix for the batch leaching experiments is shown in Tables 3.1(a), 3.1(b) and 3.1(c).

*Table 3.1(a): Preliminary Investigation Parameters on the effect of the concentration of reducing agent on leaching*

run	$[\text{NH}_3]$ (M)	$[\text{NH}_4^+]$ (M)	$[(\text{NH}_4)_2\text{SO}_3]$ (M)	Agitation ( $\text{min}^{-1}$ )	Temp ( $^{\circ}\text{C}$ )	PSD ( $\mu\text{m}$ )
1	2.0	0.2	0	300	Ambient	80% -75
2			0.01			
3			0.02			
4			0.04			
5			0.08			
6			0.1			

5g of the ore material was mixed with the reagents; 40ml of ammonia solution, 20ml of ammonium sulphite solution and 40 ml of ammonium carbonate solution with concentrations as shown in Table 3.1(a). 2ml of the leach liquor was sampled every 30 minutes for three hours. After pipetting the pregnant leach solution sample out of

the leach vessel, the sample was filtered to ensure that no residue particles formed part of the sample to be analysed and after filtration, the solution was diluted with deionised water to make 25ml of pregnant leach solution and booked for analysis by AAS. The samples were then analysed using an Agilent Technologies Series 200 atomic absorption spectrometer to determine the percentage extraction of copper, cobalt, manganese and iron. The copper and cobalt extraction represented the efficiency of the lixiviant to extract valuable metals from the ore and the manganese and iron extraction represented the efficiency of the lixiviant to reject the gangue from the pregnant leach solution.

The results of this test (See Section 4.2 in Chapter 4) show that there was no conclusive reducing agent concentration found for high extraction of copper and cobalt. Extraction for cobalt did not exceed 10% while extraction for copper did not exceed 40%. The inconclusive and unsatisfactory results prompted several speculations; either the temperature was too low to effect the necessary extraction or the concentration of reducing agent did not suffice to effect the required reduction for high cobalt and copper extraction. Two subsequent tests were performed; the first one investigating raised temperature (illustrated in Table 3.1(b)) and the second one investigating higher concentrations of the reducing agent (illustrated in Table 3.1(c)). The methodology of the test in Tables 3.1(a), 3.1(b) and 3.1(c) were performed following the flow sheet illustrated in Figure 3.2(a) shown and discussed in Sections 3.6 and 3.7 in the current chapter. The repeat test as shown in Table 3.2(b) was however, modified slightly and performed without half-hourly sampling and was run for only 60 minutes and not 180 minutes. This was because no significant improvements in extraction were observed beyond 60 minutes of leaching. The two subsequent tests did result in significantly higher observed cobalt extractions. The results were still unsatisfactory ( $\leq 40\%$  cobalt extracted into solution). In an attempt to optimise the observed extraction, a fourth run was performed at an even higher temperature following the flow sheet illustrated in Figure 3.2(b) shown and discussed in Section 3.6 in this chapter.

**Table 3.1(b) Investigation Parameters on the Effect of Reducing Agent Concentration at 60°C**

<b>run</b>	<b>[NH<sub>3</sub>] (M)</b>	<b>[NH<sub>4</sub><sup>+</sup>] (M)</b>	<b>[(NH<sub>4</sub>)<sub>2</sub>SO<sub>3</sub>] (M)</b>	<b>Agitation (min<sup>-1</sup>)</b>	<b>Temp (°C)</b>	<b>PSD (µm)</b>
1	2.0	0.2	<b>0</b>	300	60	80% -75
2			<b>0.01</b>			
3			<b>0.02</b>			
4			<b>0.04</b>			

5			<b>0.08</b>			
6			<b>0.1</b>			

**Table 3.1(c): Investigation Parameters on The effect of Reducing Agent Concentration at Increased Concentration of Reducing Agent**

<b>run</b>	<b>[NH<sub>3</sub>] (M)</b>	<b>[NH<sub>4</sub><sup>+</sup>] (M)</b>	<b>[(NH<sub>4</sub>)<sub>2</sub>SO<sub>3</sub>] (M)</b>	<b>Agitation (min<sup>-1</sup>)</b>	<b>Temp (°C)</b>	<b>PSD (µm)</b>
1	4.0	0.4	<b>0</b>	300	60	80% -75
2			<b>0.2</b>			
3			<b>0.4</b>			
4			<b>0.8</b>			

### 3.5.2. The Effect of Temperature on Leaching

The effect of temperature on the leaching of copper and cobalt was investigated. It is commonly known that the efficiency of extraction of a solid into solution is increased with increasing temperature. Since the aim of the project is to maximise the extraction of cobalt and copper and minimise the extraction of iron and manganese, it was imperative to investigate a trade-off temperature where both aims are met. The experimental conditions for the investigation on the effect of temperature on the extraction efficiency of copper, cobalt, manganese and iron is given in Table 3.2.

**Table 3.2: Investigation Parameters on The effect of temperature on leaching**

<b>Beaker</b>	<b>[NH<sub>3</sub>] (M)</b>	<b>[NH<sub>4</sub><sup>+</sup>] (M)</b>	<b>[(NH<sub>4</sub>)<sub>2</sub>SO<sub>3</sub>] (M)</b>	<b>Agitation (min<sup>-1</sup>)</b>	<b>Temp (°C)</b>	<b>PSD (µm)</b>
1	4.0	0.4	0.4	300	Ambient	-75+63
2					40	
3					60	
4					80	

The results of this test (See Section 4.3 in Chapter 4) show that raising the temperature improves the extraction of copper and cobalt until at 80°C where the extraction decreased significantly. A second test was administered to investigate the efficiency of extraction at 80°C. The test was performed following the flow sheet illustrated in Figure 3.2(b) as illustrated in Section 3.6. The test was to investigate whether the reduced copper and cobalt extractions were due to losses of hot ammonia fumes.

### 3.5.3. The Effect of Particle Size Distribution on Leaching

To investigate the optimum particle size for use in the leaching process, it was best to investigate any improvement of extraction efficiency with change in particle size. Even at the most elementary levels of science, empirical results have indicated that it is easier to dissolve finer material than to dissolve coarser material. As such, it can be hypothesised that the best extractions will be observed at finer particle sizes. That notwithstanding, finer milling increases operational costs and this part of the work will determine if finer milling would improve extraction efficiency. This is very important because if the cost of finer milling is not balanced by improved extraction efficiency, it could have an impact on the overall operational costs of the plant.

Size ranges of -150+75µm, -75+45µm, -53+38µm and -38µm were tested. 5g samples of the ore material were leached in an incubator-shaker at 300min<sup>-1</sup> at 60°C, at a  $\frac{[NH_3]}{[NH_4^+]}$  concentration ratio of 10. Samples of the pregnant leach solution were drawn every half hour for three hours. The samples were filtered, diluted in deionised water and analysed for copper, cobalt, iron and manganese in solution using AA spectroscopy. The experimental conditions for the batch is shown in table 3.1. The leaching was performed following the flow sheet in Figure 3.2(a) as illustrated in Section 3.6.

*Table 3.3: Investigation Parameters on the effect of particle size on leaching*

Beaker	[NH <sub>3</sub> ] (M)	[NH <sub>4</sub> <sup>+</sup> ] (M)	[(NH <sub>4</sub> ) <sub>2</sub> SO <sub>3</sub> ] (M)	Agitation (min <sup>-1</sup> )	Temp (°C)	PSD (µm)
1	4.0	0.4	3.4.3 Determined from Best Concentration Found in Section	300	60	-150
2						-75
3						-53
4						-38

### 3.5.4. The Effect of the Concentration of Ammonia Solution and Ammonium Carbonate on Leaching.

According to Equation 2.8 given in Chapter 2, the concentration of ammonia in the ammonia-ammonium carbonate leach solution is directly proportional to the pH while the concentration of ammonium ions in the leach solution is inversely proportional to the pH. This means that increasing the concentration of ammonia in the leach solution makes the solution more basic and increasing the concentration of ammonium ions in the leach solution makes the solution less basic.

Having determined the optimum temperature and the optimum particle size to work at, the concentration of the ammonia leach solution was varied at that temperature using the determined reducing agent concentration. The lixiviant used was an ammonia-ammonium carbonate solution of varying composition. The varying of the individual concentrations of the ammonia and ammonium carbonate in the ammonia-ammonium carbonate leach solution effectively doubles as an investigation of the best pH at which to effect leaching. The different leach batch-set ups to investigate the effect of the concentrations of ammonia and ammonium carbonate is tabulated in Table 3.4.

**Table 3.4: Investigation Parameters on The Effect of Ammonia and Ammonium Carbonate Concentrations on Leaching**

Vessel Number	[NH <sub>3</sub> ] (M)	[NH <sub>4</sub> <sup>+</sup> ] (M)	[(NH <sub>4</sub> ) <sub>2</sub> SO <sub>3</sub> ] (M)	Agitation (min <sup>-1</sup> )	Temp (°C)	PSD (µm)
1	0.5	0.1	0.4	300	80	-75
2	1					
3	2					
4	4					
5	0.5	0.2				
6	1					
7	2					
8	4					
9	0.5	0.4				
10	1					
11	2					
12	4					



13	0.5	1				
14	1					
15	2					
16	4					
17	0.5	2				
18	1					
19	2					
20	4					
21	0.5	4				
22	1					
23	2					
24	4					

In all the experiments undertaken, 5g of the ore material was leached with 40ml of ammonia solution, 40ml of ammonium carbonate solution and 20ml of ammonium sulphite solution with varying concentrations according to what was being investigated.

### 3.6. Optimisation

In later experiments including test work outlined in Section 3.4.4, an improved leaching regime was found to be imperative. This was because of the need to attempt to improve cobalt extraction; cobalt being the most valuable component of the ore. There were several tweaks and additions to the standard procedure and these are discussed in this chapter.

#### 3.6.1. Ore Reduction Pre-Treatment

To address and hopefully eliminate the possibility that there was cobalt that remained unleached in the ore, it was decided that ore pre-treatment prior to interacting the ore with the ammonia/ammonium carbonate leach solution was necessary.

Pre-Treatment was effected by preparing the required concentration of ammonium sulphite reducing agent and heating the reducing agent to a pre-determined temperature. When the reducing agent had attained the pre-determined temperature, the ore material was kept in the heated reducing agent solution for 60 minutes. Then the ammonia-ammonium carbonate leach solution of pre-determined concentrations was added to this ore-reducing agent mixture and agitation started for further 60 minutes.

### 3.6.2. Diluting the PLS in Hydrochloric Acid

It is imperative to present a solution with no solids for analysis by atomic absorption spectrometry. This is because solids choke the suction equipment of the AA-spectrometer and damage the equipment. Therefore it is imperative to filter the solution before analysis. However, filtering the solution used in the current work especially the heated solution caused a significant amount of the ammonia to be lost from the system as fumes. To prevent these fuming losses, it was decided that as far as possible the system would remain sealed. Because whatever method was used for filtration, the ammoniacal pregnant leach solution would be in an unsealed system for some time and ammonia fumes would escape, it was decided that filtration would be by-passed altogether. Therefore, instead of filtration, at the time of sampling, the residue was allowed to settle by ceasing agitation for five minutes and then pipetting from the solution phase of the mixture and immediately adding hydrochloric acid diluent. Diluting in hydrochloric acid had the two-fold effect of making it possible to by-pass filtration as a clear transparent solution would form, making the pregnant leach solution more resilient to crystallisation when in storage awaiting analysis.

### 3.7. Leaching Flow Diagrams

There were two flow sheets followed in this work. The first flow sheet illustrated in Figure 3.2(a) was performed for preliminary tests. These first tests showed relatively unsatisfactory ( $\leq 40\%$ ) cobalt extraction. This prompted further investigation and a more optimised leaching flow sheet. The more optimised flow sheet was intended to improve cobalt losses by reducing ammonia losses to fumes. Ammonia losses occur during sample filtration and solution crystallisation due to temperatures dropping during storage. Furthermore, the leaching flow sheet was intended to improve the extraction of cobalt. Since it was not determined whether the cobalt was lost from solution or remained in the residue, work from reported research work (Welham et al., 2015) was considered. In the work (Welham et al., 2015) pre-treatment was emphasised as being absolutely essential for high cobalt extraction.

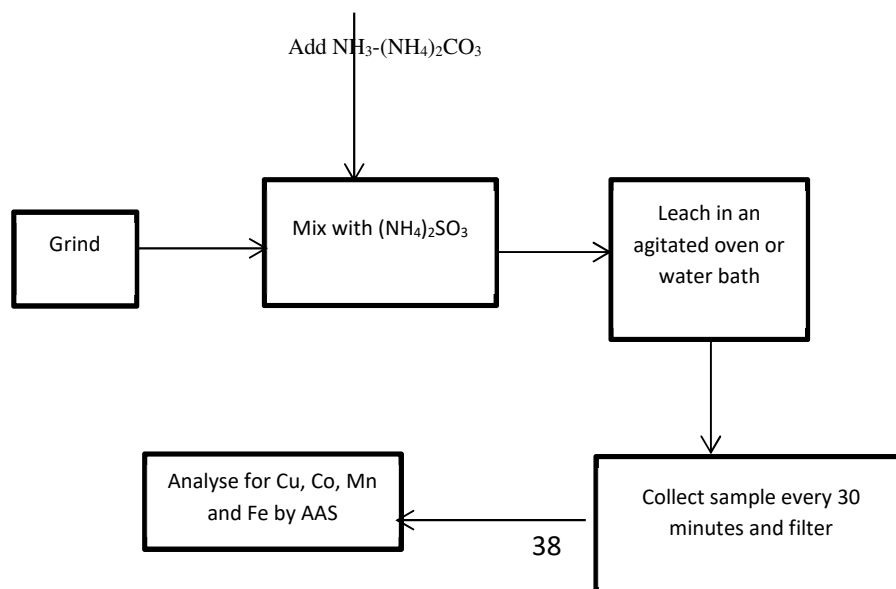

**Figure 3.2(a): Leaching flow diagram for Preliminary Tests**

For the optimisation tests whose results are reported in Section 4.6 and the test illustrated in Table 3.4 whose results are reported in Section 4.5 and the specifically mentioned further investigation tests including the tests performed at 80°C, the generic procedure illustrated in Figure 3.2(a) was changed to the procedure illustrated in Figure 3.2(b) to attempt to improve the extraction and to eliminate logistical issues that had been noted during the previous tests.

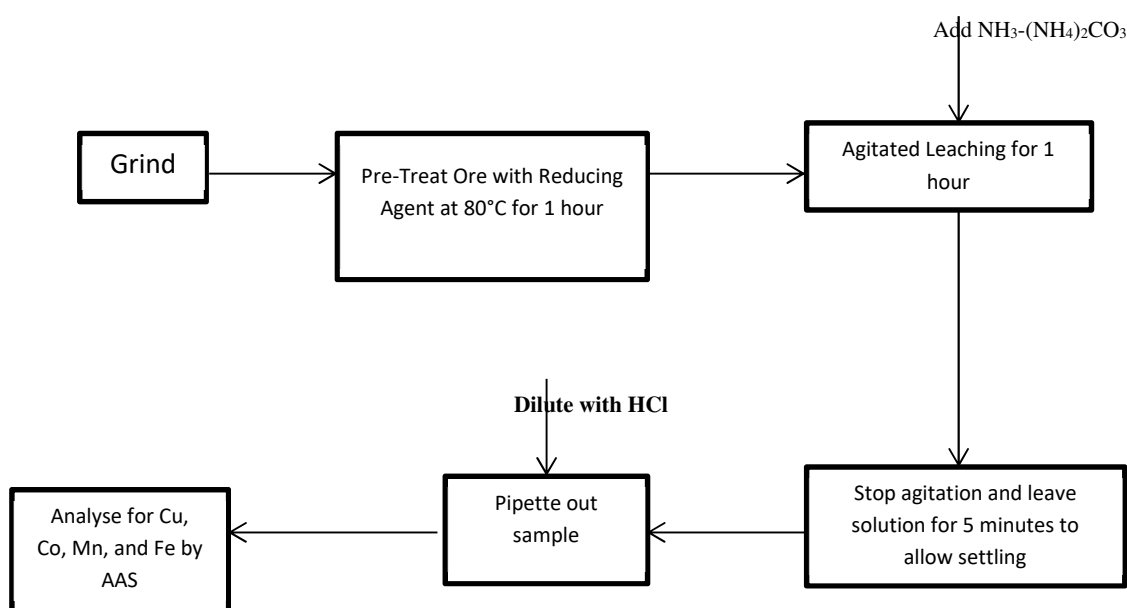

**Figure 3.2(b): Optimised Flowsheet for Leaching**

For the latter investigations reported in Sections 4.5 and 4.6, the leaching procedure was performed using the flow diagram illustrated in Figure 3.2(b). To be exact, the ore sample was kept in 0.4M ammonium sulphite at 80°C for 1 hour and then mixed with the ammonia-ammonium carbonate leach solution. Leaching under agitation at 80°C for 60minutes was then conducted. After 60 minutes of leaching, agitation was stopped for 5 minutes while the heat source was left running. After 5 minutes a 2ml sample was removed from the leaching vessel and diluted to 50ml with 2M hydrochloric acid.

The arguments that led to the suggestion that Figure 3.2(b) would be an improvement over Figure 3.2(a) are outlined further in Section 4.6.

The 5 minute wait was to allow the leach residue to settle to minimise any solids that can clog the suction pipe of the AA equipment. The sample was diluted in hydrochloric acid to by-pass ammonia losses that happen during sample filtration. The pre-treatment was run at a raised temperature because preliminary results from this current work and from the work of Thobejane (2016), who did comparable work, found that

pre-treatment (at ambient temperature) did not yield a significant extraction advantage when compared to just adding a reducing agent as a part of the leaching solution. These findings were in spite of the findings by other researchers (Welham et al., 2016) who found pre-treatment imperative for high cobalt extraction. Preliminary pre-treatment in this work and by the aforementioned researcher, (Thobejane, 2016), was carried-out at ambient temperature. This prompted an investigation of pre-treatment at elevated temperature.

These multiple investigations into pre-treatment were motivated by the fact that the researchers (Welham et al., 2015) that reported high ( $\leq 100\%$ ) extraction caused by *inter alia* pre-treatment reported neither the pre-treatment temperature nor the leaching temperature. Therefore, even though pre-treatment had found favour in other projects (Welham et al., 2015), there was still empirical data necessary to optimise pre-treatment. When investigating an optimised leaching procedure, raising the temperature from 60°C to 80°C was investigated and adopted as the temperature of the optimised leaching regime. Under these conditions, it was found that the raised temperature would allow for better leaching efficiency and the test in Section 3.4.4 was carried-out exclusively following the flow sheet in Figure 3.2(b)

# Chapter 4

## Results and Discussion

### 4.1. The composition of the Ore

The mineral phases of the ore were determined through an XRD analysis and an XRF analysis was done for the elemental composition of the ore. The elemental composition of the ore is tabulated in Table 4.1.

The ore material analysis results reported are shown in Table 4.1(a) and 4.1 (b).

*Table 4.1 (a): Elemental Analysis by size of the ore material*

Metal	Weight % in Ore			
	-150+90µm	-75+63 µm	-53+45 µm	-38 µm
Cu	6.357	8.021	5.072	4.214
Co	0.627	0.885	0.492	0.437
Fe	1.98	2.44	1.66	1.47
Mn	0.31	0.42	0.24	0.23
SiO <sub>2</sub>	73.68	78.97	81.62	83.06

*Table 4.1 (b) Ore Mineral Phase Analysis (Kyembo, 2015)*

-75µm		+75µm		Bulk ore	
<b>Chlorite</b>	9.64	<b>Chlorite</b>	5.55	<b>Chlorite</b>	7.27
<b>Dolomite</b>	0.56	<b>Dolomite</b>	1.87	<b>Dolomite</b>	0.77
<b>Malachite</b>	6.58	<b>Malachite</b>	4.35	<b>Malachite</b>	4.68
<b>Muscovite</b>	2.23	<b>Muscovite</b>	1.05	<b>Muscovite</b>	0.91
<b>Quartz</b>	76.94	<b>Quartz</b>	83.1	<b>Quartz</b>	82.35
<b>Talc</b>	4.04	<b>Talc</b>	4.07	<b>Talc</b>	4.02

Table 4.1 (a) shows that the bulk ore is a high grade copper and cobalt ore hosted in silica gangue. The ore is said to be high grade because it is common knowledge that

copper grades as low as 0.5% copper and cobalt ores as low as 0.1% can be processed profitably (Crundwell et al., 2011). The highest grade was found in the -75 $\mu$ m size fraction from the current work and in the -75 $\mu$ m size fraction in the cited work by Kyembo (2015).

The mineral phase analysis shown in Table 4.1 (b) indicates that the ore is high grade malachite with chlorite and quartz. The results in Table 4.1(b) are based on the report from the work done by Kyembo (2015), a researcher who worked on the same ore in the research group. The data from Table 4.1(a) will be used in this work to calculate the extraction fractions.

Mineral phase analysis was performed using x-ray diffraction (XRD). XRD analysis is a major phase identification technique and could only identify the quartz in the ore from the sample sent for this work. Results from another researcher (Kyembo, 2015) who had worked on the same ore material prior to the current work were used to get some knowledge on the mineral phases of the ore.

The copper bearing mineral in the resource was found to be malachite. XRD analysis (Kyembo, 2015) did not report any known cobalt, iron ore manganese bearing minerals in this ore. It was speculated that the cobalt was associated to iron and manganese bearing phases of the ore. It was also speculated that the iron and manganese were residing in the muscovite and chlorite phases. Some other researchers (Welham et al., 2015) also speculated that in the DRC ore cobalt existed associated to manganese wads. Therefore there was some justification to the speculation that the cobalt resided associated to the chlorite and muscovite phases. The main gangue mineral was found to be silica identified as crystalline quartz. Apart from these observations, it was observed from Table 4.1(a) that the highest grade of the resource was in the -75 $\mu$ m fraction where the ore was 0.88% cobalt and 8.02% copper. This finding led to the conclusion that the copper and cobalt were most concentrated in the -75 $\mu$ m size fraction. It was further observed that the grade of the ore decreased significantly in the finer fractions although it was still high enough to remain significant.

It is difficult to plan a leaching regime just from the assay because it is not clear where the cobalt resides in the ore material. Empirical knowledge of the cobalt-bearing mineral phase in the ore prior to leaching would make it easy to determine when to utilise a reducing agent in leaching. For instance, in the high pressure acid leaching of limonitic nickel-cobalt ore, leaching is performed without a reducing agent because the cobalt (and nickel) exist in divalent oxidation states (Crundwell, 2011). This undetermined data about cobalt-bearing minerals in the ore is not prohibitive though as the elemental analysis confirms that the resource is a high grade cobalt ore.

## 4.2. The Effect of reducing agent on leaching

The first investigation looked at the effect of the concentration of the reducing agent on the leaching efficiency of cobalt and copper. The initial argument was that it is possible that a reducing agent would not be required in this work if the cobalt existed in the ore independent of manganese and iron. If not, then a reducing agent would be required. It would then be necessary to find the minimum concentration of the reducing agent that would be required to leach maximum cobalt into solution.

Three replicate experiments using the reducing agent were run at ambient temperature. The concentration of the reducing agent was varied from no reducing agent to 0.1M concentration. Samples were taken every 30 minutes. There was no conclusive improvement on the extraction of cobalt with an increase in the concentration of the reducing agent. The extraction of cobalt into solution could not exceed 10%, which meant that more than 90% of the valuable metal was lost to residue. This was undesirable and did not lead to a conclusion on the amount of reducing agent that needed to be used in subsequent leaching experiments.

It is also important to note that the leaching conditions reported in Fig. 4.1(a) reported low extraction of both value metals. Cobalt extraction did not exceed 10% in these leaching conditions while copper extraction did not exceed 30% on average.

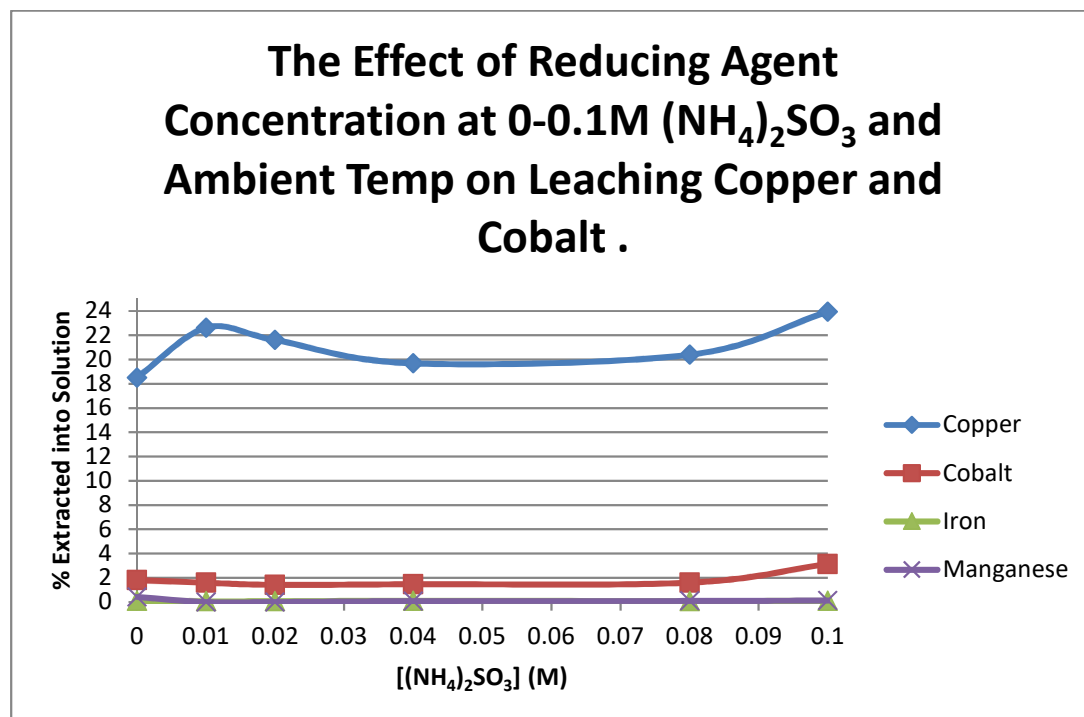

[NH<sub>3</sub>]: 2M; [NH<sub>4</sub>CO<sub>3</sub>]:0.2M; Agitation: 300rpm; Temperature: Ambient; PSD: -75µm, Leach time: 60 mins

*Fig 4.1(a)(i): The Effect of Reducing Agent Concentration at 0-0.1M and at Ambient Temperature on the Efficiency of Leaching Copper and Cobalt*

### The Effect of Reducing Agent Concentration on Leaching Copper and Cobalt at 0-0.1M and Ambient Temperature with Changing Time

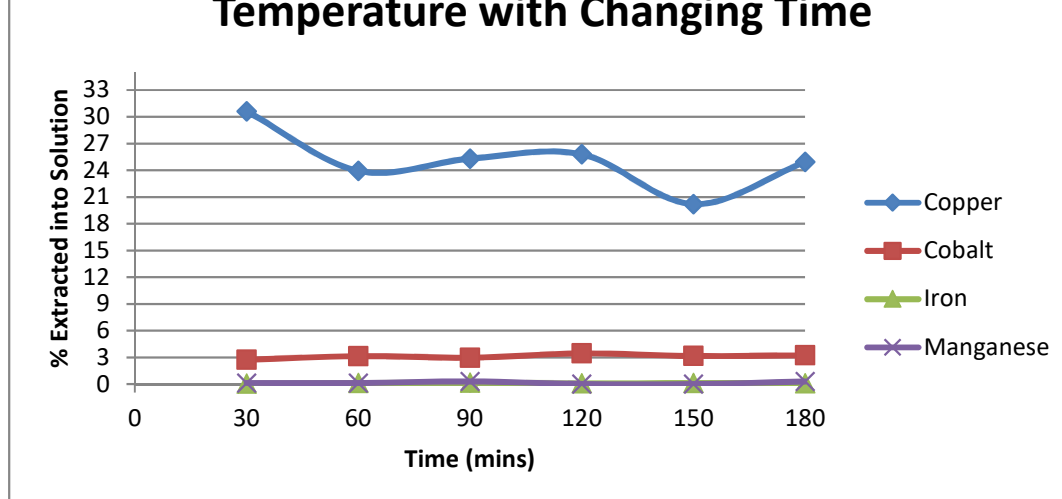

[NH<sub>3</sub>]: 2M; [NH<sub>4</sub>CO<sub>3</sub>]:0.2M; [(NH<sub>4</sub>)<sub>2</sub>SO<sub>3</sub>]: 0.1M Agitation: 300rpm; Temperature: Ambient; PSD: -75µm,  
**Fig 4.1(a)(ii): Preliminary Investigation of the Effect of a Reducing Agent Showing Changes in Leaching Efficiency with Time at 0.1M Ammonium Sulphite.**

The low extraction efficiency of cobalt and copper observed in Figure 4.1(a) may have been due to either the low temperature or the low concentration of reducing agent used. The suspicion of temperature was further bolstered by other researchers (Niinae et al., 1994; Das et al., 1986) who did comparable work. They ran their experiments between 50°C and 80°C (Niinae et al., 1994) and between 65°C and 160°C (Das et al., 1986). It is worth noting that these other researchers did not attempt to effect leaching at ambient temperature, hence the suspicion that the low extraction was due to low temperature.

Furthermore, Figure 4.1(a) (ii) shows that only a little increase in extraction efficiency occurs after 60 minutes. There was no discernible change of cobalt extraction with time. As a result, it was decided that the extraction was a fair representation of analysed percentage extraction after 60 minutes. There was a fluctuation of the copper extracted into solution for the entirety of the three hours and no reliable trend could be established. It is suspected that the unreliable trend in leaching was caused by primarily the low leaching temperature that caused the extracted copper in solution to be unstable. Consequently, the copper went into solution due to agitation but would rapidly precipitate when agitation was turned off because the temperature did not suffice for the copper to remain in solution.

To confirm the role that temperature played in the low extraction efficiencies observed, a supplementary test was performed. The leaching was carried out using the leach conditions as tabulated in Table 3.1(b). Under these conditions, the reagent concentrations were unchanged, but the temperature of leaching raised to 60°C



following the flow sheet illustrated in Figure 3.2(a). Further tests performed involved increasing the concentration range of the reducing agent. In doing this test, the concentration of ammonia and ammonium carbonate was increased to counter the effect of the increased ammonium ion concentration from the ammonium sulphite on the pH. The results of these experiments are shown in Figure 4.1(b) and 4.1(c).

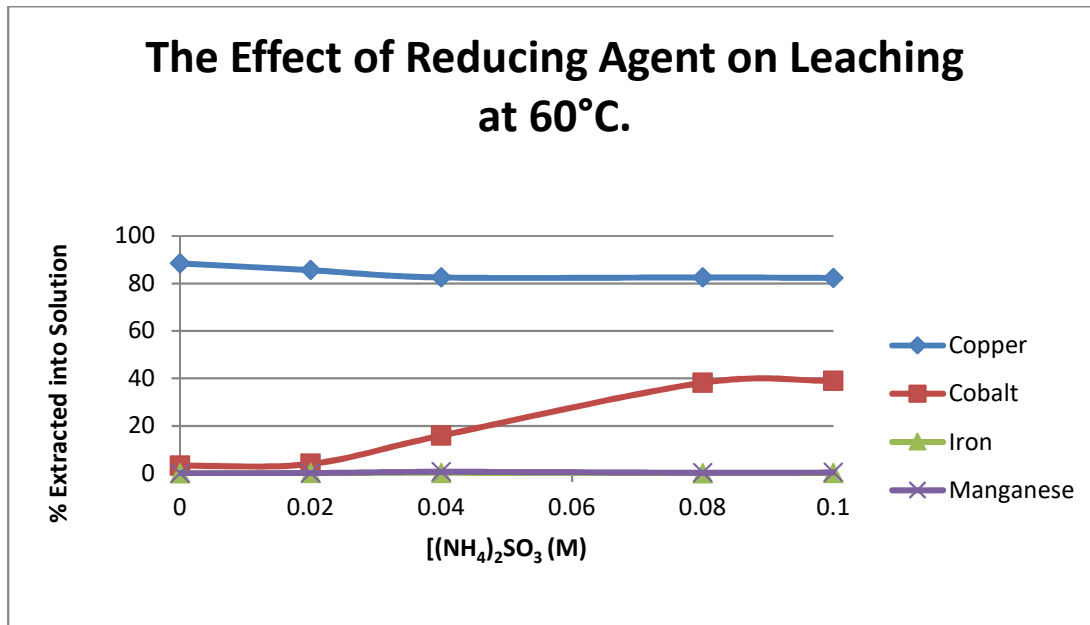

[NH<sub>3</sub>]: 2.0M; [(NH<sub>4</sub>)<sub>2</sub>CO<sub>3</sub>]: 0.2M; 300rpm; 60°C; Leaching: 60minutes; PSD: -75+63µm

Figure 4.1(b): The Effect of Reducing Agent Concentration on Leaching at 60°C.

Figure 4.1(b) shows that when the temperature is raised under the same initial leaching conditions as in Figure 4.1(a), the extraction of copper and cobalt rises quite substantially. There was no half-hourly sampling in this supplementary test because the test was meant to investigate if the observed low recovery was due to the low temperature of the test, whose results are reported in Figure 4.1(a).

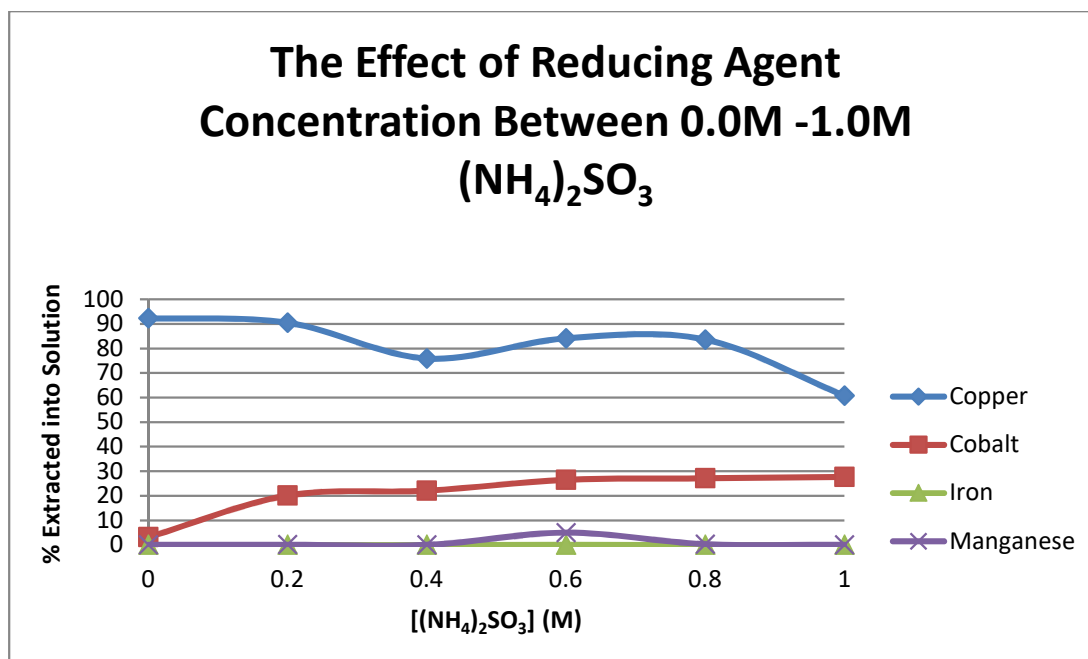

$[\text{NH}_3]: 4.0\text{M}; [(\text{NH}_4)_2\text{CO}_3]: 0.4\text{M}; 60^\circ\text{C}; 300\text{rpm}; \text{Leaching Time: } 60\text{mins.}$

**Figure 4.1(c): The Effect of Reducing Agent Concentration on Leaching with Increased Reagent Concentrations**

Figure 4.1(c) shows that increasing reducing agent concentration did not result in an improvement in extraction efficiency of copper and cobalt relative to the initial test work whose results are reported in Figure 4.1(a). However, Figures 4.1(a), 4.1 (b) and 4.1 (c) also show that an increase in the concentration of the reducing agent tends to decrease the efficiency of the extraction of copper in overall. There are two possible reasons. The first possible reason is that the leached copper ions could be getting reduced to copper metal with increased reducing agent concentration and then reporting to the residue because copper metal is more difficult to leach than oxide copper minerals. The second possibility could be that the copper forms a precipitate of sulphite compounds ( $\text{CuSO}_3 \cdot \text{Cu}_2\text{SO}_3 \cdot 2\text{H}_2\text{O}$ ) that are difficult to leach. This is a reported (Ferron, 2008) adverse effect of using aqueous sulphur dioxide ( $\text{H}_2\text{SO}_3$ ) as the primary reducing agent (Ferron, 2008). It is possible that one or both of these reactions are causing reduced copper extraction when the concentration of reducing agent is increased. It is however most likely that the reduced copper extraction is caused by precipitation of metallic copper.

Figures 4.1 (a) and 4.1 (b) show that increasing the leaching temperature increases leaching efficiency of both copper and cobalt while increasing the concentration of the reducing agent favours improved cobalt extraction, but has a negative impact on the copper extraction. Figure 4.1(c) shows an unreliable trend and prompts further investigation of the entire method. This investigation is reported in Section 4.6. This result however, presents a slight processing complication when processing the mixed ore. Since it was observed that copper leaching efficiency decreased with an increase in the concentration of the reducing agent, it is believed that in practice the best extraction efficiency for both copper and cobalt can be achieved by first subjecting the

ore to leaching in a non-reducing environment, then treating the residue under a reducing environment.

### 4.3. The Effect of Temperature on Leaching

The work in Section 4.2 determined the effect of a reducing agent concentration on leaching and also underscored the effect of temperature. Having determined the importance of temperature, subsequent work investigated this in some greater detail. The temperature was raised from ambient to 80°C. The results showing the effect of temperature on leaching are shown in Figure 4.2.

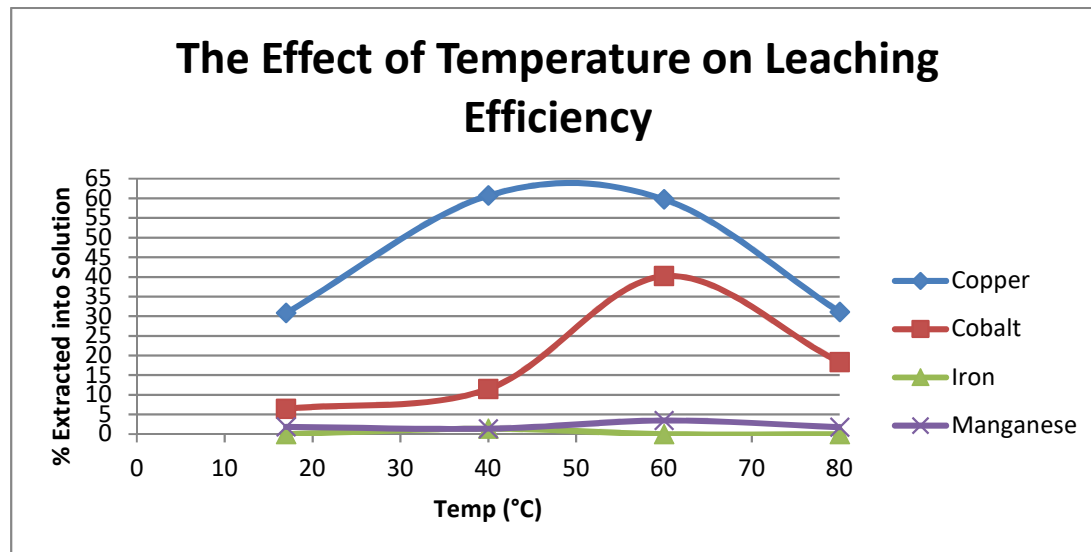

[NH<sub>3</sub>]: 4.0M; [(NH<sub>4</sub>)<sub>2</sub>CO<sub>3</sub>]: 0.4M; [(NH<sub>4</sub>)<sub>2</sub>SO<sub>3</sub>]: 0.4M;; 300rpm; 90mins  
 Fig 4.2: The Effect of Temperature on Leaching

The results in Figure 4.2 showed that there is very low extraction of cobalt at ambient temperature. Extraction for cobalt increased at 40°C to about 11%. Peak extraction for cobalt was observed at 60°C. At this temperature, extraction rose to about 40%. When the temperature was further raised to 80°C, cobalt extraction was, however, observed to decrease significantly. The reason could be that at 80°C, the lixiviant becomes violently effervescent. As a result, unsealing the leaching vessel to collect periodic samples caused high ammonia losses as fumes. Furthermore, if the unsealing of the vessel were not done carefully, even the solution would be boiling so violently as to fizzle out of the leaching vessel. This is believed to have caused the diminished extraction.

In the case of copper, the extraction was a lowly 31% at ambient temperature and peaked to 61% at 40°C. When the temperature was raised to 60°C the extraction did not improve but decreased slightly to 60%. When the temperature was raised further to 80°C, copper also showed significant decrease in extraction.

These results for the effect of temperature were further affected by logistical issues that may have affected their reliability and also begged further investigation to make them more reliable. Firstly, after leaching at different temperatures the samples were required to be stored at ambient temperature before analysis. Furthermore, as the temperature of leaching rose, the solution became increasingly effervescent and released more ammonia fumes during sampling. It is suspected that this ammonia loss to fumes caused the decreased copper and cobalt extraction as temperature rose. When compared to results observed and reported in Figure 4.1(c) and Figure 4.5, the combined effects of storage (the inevitable crystallisation due to temperature drop) while awaiting the required subsequent analysis made the results unreliable and necessitated an improvement of the leaching procedure. The results reported in Figure 4.5 were also from samples that were more resilient to the adverse effects of storage because they were stored as chlorides while the results reported in Figure 4.1(c) were from samples which were in storage for a shorter period and were not diluted. The samples for the effect of temperature reported in Figure 4.2 were analysed about five (5) days after they were leached while the samples reported in Figure 4.1(c) were analysed a day and a half after leaching.

In published work by Das et al., (1986); Niinae et al., (1994) peak extractions were observed at temperatures between 80 and 100°C. Peak extractions did however, also decrease significantly when temperature was raised higher than 100°C (Das et al., 1986). Copper extraction peaked at a reported (Das et al., 1986) 80°C and decreased significantly beyond that temperature while cobalt extraction peaked at 100°C (Das et al., 1986) and also decreased significantly beyond that temperature (Das et al., 1986). Both pieces of cited work (Das et al., 1986; Niinae et al., 1994) reported continuous leaching as opposed to periodic sampling as performed in the work being reported herein. A case could thus be made for the poor extraction at 80°C in this work to be due to significant cumulative ammonia losses as sampling was performed. The solution to such a problem would then be found if the leaching was continuous and the leach vessel remained sealed by by-passing periodic sampling and also by-passing filtration by dissolving the PLS samples awaiting analysis with hydrochloric acid as opposed to deionised water. Unsealing the leach vessel causes significant amounts of ammonia fumes to be lost to the atmosphere especially as the temperature was raised.

From the discussion above, it was therefore deemed necessary to investigate the extraction of copper and cobalt at 80°C by leaching constantly without half-hourly sampling. Furthermore, it was necessary to by-pass filtration to reduce losses. The residence time of the sample on filter paper during the filtration process was approximately 30 minutes. In this time the temperature of the sample was significantly reduced. Thus resulting in crystallisation of the sample. Furthermore, since the sample was hot and not sealed when introduced to filter paper, the hot ammonia would be lost to the atmosphere. A combination of decreased temperature and decreased concentration of ammonia solution caused precipitation of the species in solution onto filter paper. It was thus decided that an improved leaching methodology would ideally

by-pass filtration altogether as opposed to attempting to improve the filtration process. The results for this test are shown and discussed in Section 4.6 under optimisation of the leaching process.

#### 4.4. The Effect of Particle Size Distribution on Leaching

Figure 4.3 shows the percentage extraction of metals when the particle size distribution was sequentially changed. Using the grades in the different size fractions in the ore (Table 4.1a), the extraction efficiency could be computed.

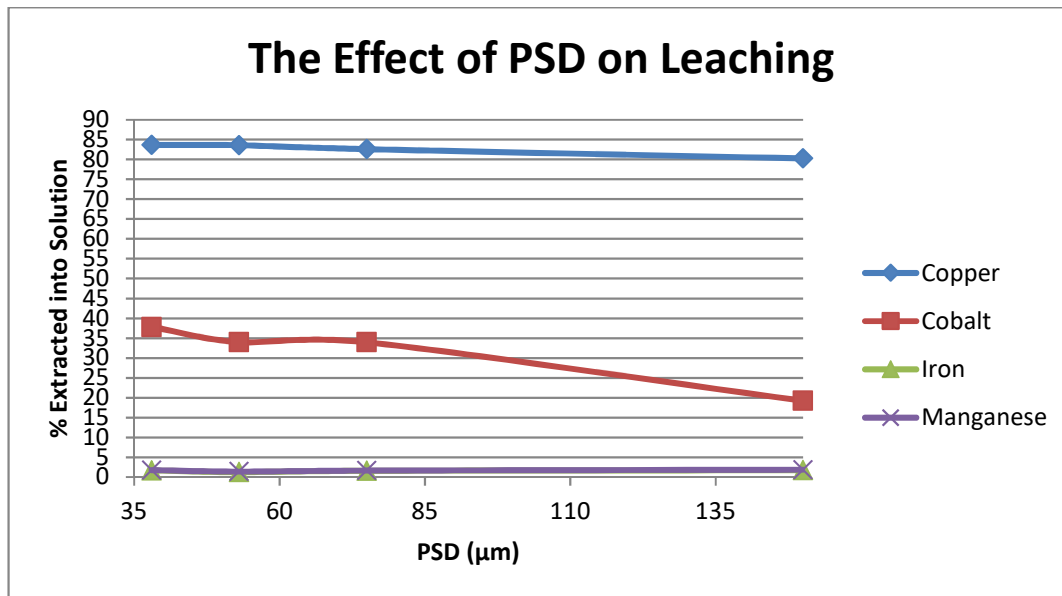

[NH<sub>3</sub>]: 4.0M; [(NH<sub>4</sub>)<sub>2</sub>CO<sub>3</sub>]: 0.4M; [(NH<sub>4</sub>)<sub>2</sub>SO<sub>3</sub>]: 0.4M; 300rpm; 60°C; 60 minutes.

**Figure 4.3: The effect of particle size distribution on leaching efficiency**

Figure 4.3 shows that there is no significant improvement of copper extraction from the ore when the ore is milled finer than -75μm. The extraction remained at around 83%. The cost of milling finer than 75μm was thus not be mitigated by increased copper extraction.

At the coarsest tested particle size of -150μm, cobalt extraction was about 19%. At the size of -75μm, cobalt extraction was about 34%. Milling finer to -53μm resulted in no improvement in extraction. At the finest particle size of -38μm there was slight extraction improvement to 38%.

Because there is no significant improvement in extraction from the copper and the cobalt when milling finer than -75μm, a case can be made that the best cost/value compromise is at -75μm. Although this was not investigated, it is suspected the slight increase in extraction efficiency reported when milling was finer than 38μm might not suffice to justify the cost of fine milling. Analysis of the samples for this particular test was performed about 12 hours after leaching.

Furthermore, in actual plant practice, there will be no convenient laboratory-scale size fractions, the ore will be milled at an unrestricted -75μm which encompasses the -

53 $\mu\text{m}$  and -38 $\mu\text{m}$  particles as opposed to the laboratory-scale -75+63 $\mu\text{m}$ , which for test purposes was restricted to particles finer than 75 $\mu\text{m}$  but coarser than 63 $\mu\text{m}$ .

#### **4.5. Troubleshooting and Optimising Cobalt Extraction**

Cobalt being the more valuable component of the ore, it was imperative to make improvements to the leaching regime. During troubleshooting and returning to the literature as well as considering observations and experiences from laboratory work, the following likely causes for relatively poor extraction of cobalt were shortlisted. A leaching procedure that addressed these likely causes was devised.

- The cobalt remained unextracted during leaching and thus reported to the residue;
- Higher extraction could be achieved at higher temperature (80°C) if the leaching vessel remained sealed throughout the leaching process.
- The cobalt was effectively leached but precipitated on filter paper when solution filtration was effected. This was due to ammonia losses to fumes and a significant temperature drop as the solution resided on filter paper for about 30 minutes;
- The cobalt was leached and successfully extracted into solution, remained as part of the filtrate but crystallised when the pregnant leach solution was in storage awaiting analysis.
- Cumulative effects of the three above-mentioned possibilities manifested as diminished cobalt extraction.

The optimised leaching regime assumed the fifth possibility that the cumulative effects of the above-mentioned possibilities caused diminished extraction. These likely causes were thus addressed and tests performed to investigate the extent of improvement when implementing the changes.

To address the first possibility, if the cobalt remained unextracted during leaching, it was imperative to render the cobalt more amenable to leaching. This was done by effecting pre-treatment as suggested in literature (Welham et al., 2015). In preliminary tests performed in collaboration with another researcher (Thobejane, 2016) pre-treatment had been effected at ambient temperature and had little effect in cobalt extraction. It only increased extracted manganese. Pre-treatment was thus initially abandoned. When the results showed predominantly poor cobalt extraction, pre-treatment was re-explored with a few adjustments. Pre-treatment was effected by adding the ore material into a pre-determined (0.4M) concentration of pre-heated (80°C) reducing agent (ammonium sulphite) solution for a pre-determined period (60 minutes). The pre-treatment action would have a two-fold effect. Since it had not been determined which phase of the ore the cobalt resided in, it was expected that pre-treating the ore would free the cobalt from its intimate associations. Secondly, the cobalt would be converted to its divalent form which is believed to be more amenable to leaching.

It had been noted in Section 4.2 that low temperature inhibits extraction of the valuable metallic species. It was further noted in Section 4.2 that other researchers (Niinae et al., 1994 and Das et al., 1986) who reported higher extractions, reported such high extractions at elevated temperatures between 80°C and 100°C. Moreover, instability of ammonia was only thought to occur at 160°C (Das et al., 1986). It was thus decided to effect leaching at 80°C.

The third possible hindrance to high cobalt extraction was that the cobalt was getting extracted into solution during agitated leaching but precipitating on filter paper when sample filtration was effected. It was speculated that a combination of ammonia losses to fumes occurring to the solution as it stayed on filter paper and the inevitable temperature drops as the sample spent a long time (about 30 minutes) on filter paper led to precipitation of cobalt onto filter paper. To address this possibility, at the time of sample collection, agitation on the sample was stopped but the heating left on, the sample was allowed to settle and pipetted from the solution phase while still in contact with the heat source. After sampling, dilution was immediately effected with hydrochloric acid as opposed to deionised water. These actions effectively eliminated the requirement for filtration as the indigo blue solution turned into a clear transparent solution that remained transparent and without solids even in storage. Hence, diluting the pregnant leach solution with hydrochloric acid duly addressed the possible losses from storage. This improvement to the method would possibly also make the pregnant leach solution more resilient to the adverse effects of storage.

Section 4.3 shows that increasing the temperature above 60°C causes decreased extraction. Since work by other researchers (Das et al., 1986) reported that decomposition of ammonia was suspected at temperatures greater than 160°C. The possibility of ammonia decomposition was set aside and it was suspected that the decreased extraction was caused by losses of ammonia to fumes. To investigate this suggestion, leaching was repeated at 80°C but was carried out continuously in a sealed vessel with the aim of reducing losses to fumes. The results of leaching at 80°C are illustrated in Figure 4.4.

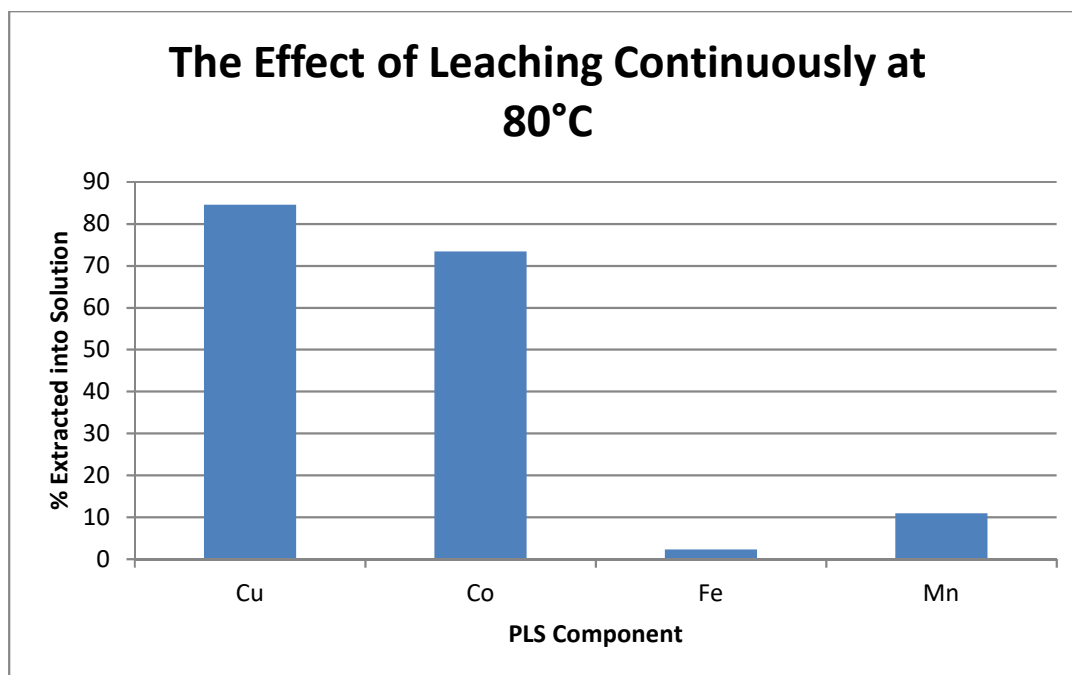

*[NH<sub>3</sub>]: 4.0M; [(NH<sub>4</sub>)<sub>2</sub>CO<sub>3</sub>]: 0.4M; [(NH<sub>4</sub>)<sub>2</sub>SO<sub>3</sub>]: 0.4M; 300rpm; Pre-Treatment: 60 mins; Leaching:60mins*  
**Figure 4.4: The Effect of Leaching at 80°C**

Figure 4.4 shows that when the sample was kept in reducing agent prior to continuous leaching in a sealed vessel at 80°C with filtration by-passed and substituted with dilution with 2.0M hydrochloric acid, appreciably high extractions of copper and cobalt could be recorded. The only downside when the temperature was raised was an increase in the extraction of manganese. This can be remedied by oxidising the pregnant leach solution in an air/sulphur dioxide mixture after leaching. The air/sulphur dioxide mixture is preferred because it does not oxidise cobalt. Cobalt is required to be in a divalent state to regulate electrowinning costs. If the potential is monitored and controlled by appropriate addition of reducing and/or oxidising agent such that the potential is in the range of 0.0V-0.25V, the cobalt remains divalent but the manganese and iron precipitate. Figure 4.4 further showed that raising the temperature to 80°C was a step in the right direction.

The second investigation to attempt to optimise cobalt extraction employing the flowsheet in Figure 3.2(b) was undertaken. This test investigated the effect of reducing agent concentration when optimised conditions were employed. The results of the investigation are illustrated in Figure 4.5.



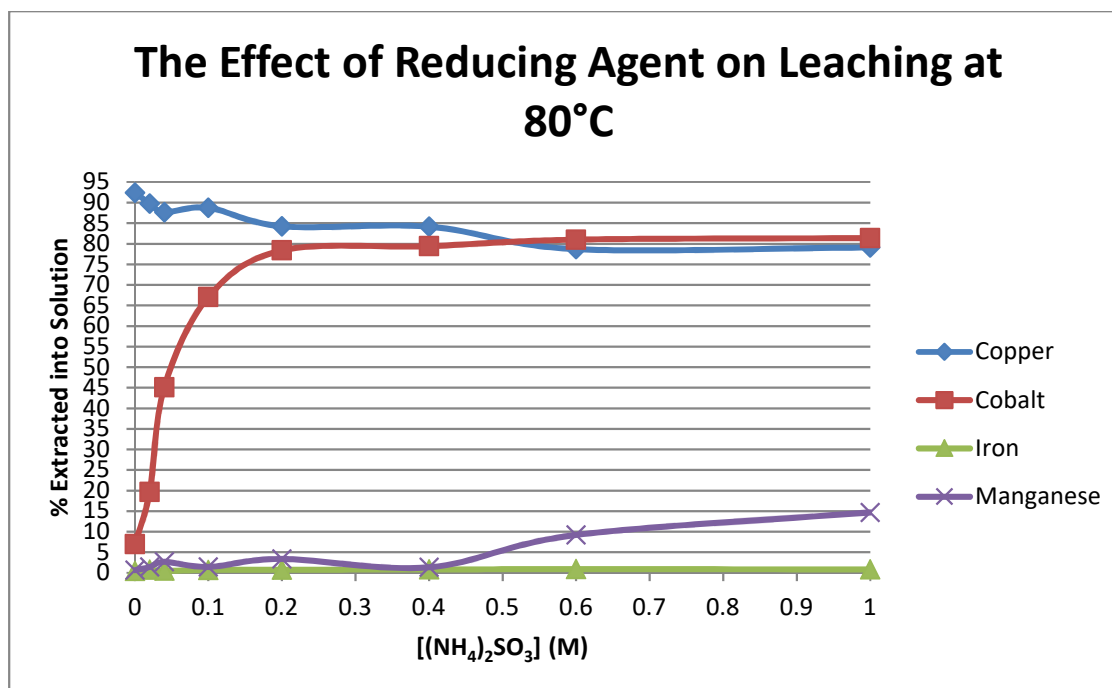

*[NH<sub>3</sub>]: 4.0M; [(NH<sub>4</sub>)<sub>2</sub>CO<sub>3</sub>]: 0.4M; 300rpm; 80°C; Pre-Treatment: 60minutes; Leaching: 60minutes.  
 Figure 4.5: The Effect of Reducing Agent Concentration With Optimised Conditions Employed.*

Figure 4.5 shows that even at high temperature; an increase in the extraction of a reducing agent favours an increase in the concentration of cobalt while decreasing the extraction of copper. An increase in the concentration of a reducing agent also favours an increase in the extraction of manganese. That notwithstanding, published work (Niinae et al., 1994) reports that an increase in the concentration of ammonium sulphite favours the eventual formation of a solid species  $(\text{NH}_4)_2\text{Mn}(\text{SO}_3) \cdot 2\text{H}_2\text{O}$  which eventually rejects manganese from solution. In spite of the formation of the solid manganese species, the work (Niinae et al., 1994) still reported manganese extraction as high as 30% in some experiments when increasing the concentration of reducing agent. Further still, increasing the concentration of the reducing agent might favour the generation of a reducing atmosphere in which the manganese ammine complex is stable (refer to table 2.1 Section 2.6.2 in Chapter 2). This unfavourable development can possibly be solved by using a sulphur dioxide/air mixture to oxidise the pregnant leach solution to form the practically insoluble trivalent and/or tetravalent manganese. If the oxidising agent is utilised with monitored potential to regulate addition of the oxidising agent such that the potential ranges between 0.0V and 0.25V, it is possible that the cobalt will remain in a divalent form. This step can be added to the process flow diagram as a solution purification step after leaching. This step should theoretically not result in significant cobalt losses because thermodynamic data shows that even if some of the cobalt is oxidised with the manganese, the trivalent cobalt ammine species is stable in solution.

#### 4.6. The Effect of the Concentrations of Ammonia and Ammonium Carbonate

Having in some way established the best cost/value compromises for the concentration of a reducing agent, particle size distribution, temperature and an optimised leaching procedure, the next test performed was to determine the effect of the concentrations of ammonia and ammonium carbonate. The results of these tests are plotted in Figures 4.6.

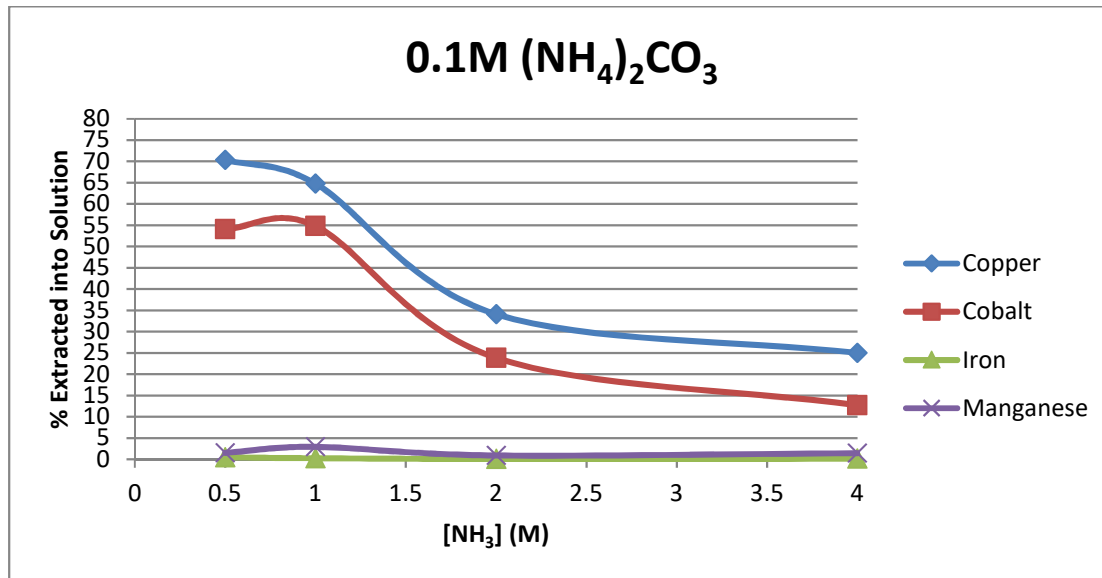

*[(NH<sub>4</sub>)<sub>2</sub>SO<sub>3</sub>]: 0.4M; 80°C; 300rpm; -75+63μm; Pre-Treatment Time: 1hour; Leach Time: 1hour;*  
**Figure 4.6(a): The Effect of Changing Ammonia Solution Concentration at Fixed 0.1M Ammonium Carbonate**

Figure 4.6(a) shows the leaching efficiency when the concentration of ammonium carbonate was fixed at 0.1M and the concentration of ammonia solution sequentially increased. The results show that at 0.1M ammonium carbonate, increasing the concentration of ammonia does not yield better extraction. The results show a decrease in both copper and cobalt extraction when ammonia is increased. It is believed that an increase in the ammonia solution concentration results in an associated increase in the solution pH. As the concentration of ammonia increased from 0.5M to 4.0M, in 0.1M ammonium carbonate, the pH increased from pH 10.61 to pH 11.77. At 4.0M ammonia solution concentration, the [NH<sub>3</sub>]:[NH<sub>4</sub><sup>+</sup>] ratio is 40.

It is believed that as the pH rose, oxides, hydroxides and carbonates started to co-exist with the ammine complex but since the hydroxides, oxides and carbonates tend to precipitate, this resulted in decreased metal extraction. Thermodynamic data illustrated in Figure 2.4 shows that at high pH, copper (II) oxide is dominant over the copper ammine complex and cobalt (II) hydroxide and cobalt (II) carbonate preferentially form over the cobalt ammine complex.

The next test was performed by keeping the concentration of ammonium carbonate at 0.2M and sequentially changing the concentration of ammonia solution. The results of this test are shown graphically in Figure 4.6(b).

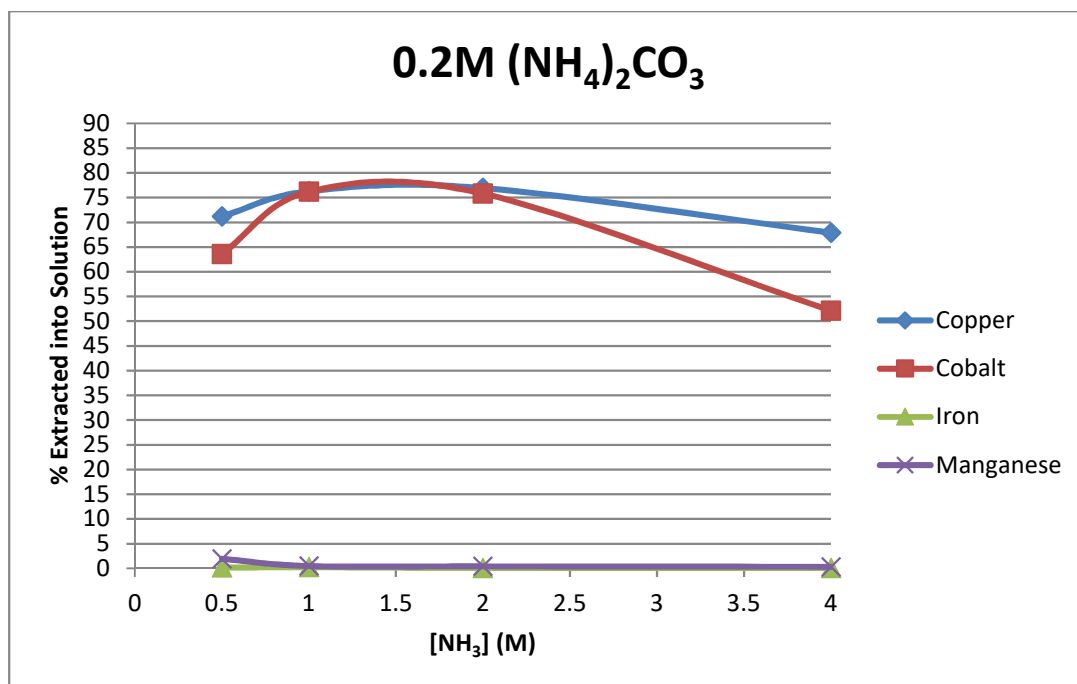

[(NH<sub>4</sub>)<sub>2</sub>SO<sub>3</sub>]: 0.4M; 80°C; 300rpm; -75+63µm; Pre-Treatment Time: 1 hour; Leach Time: 1 hour;  
**Figure 4.6(b): The Effect of Changing concentration of Ammonia Solution At Fixed 0.2M Ammonium Carbonate**

Figure 4.6(b) shows that copper and cobalt extractions were highest between 1.0M and 2.0M where the extraction of both metals was around 75%. It can also be seen that relatively high copper and cobalt extractions were observed over a longer range of ammonia solution concentrations when compared to the extractions observed in Figure 4.6(a) discussed earlier.

This observation could be due to the fact that the ammonia to ammonium ion ratio rose from 2.5 to 20 as the concentration of ammonia solution was increased from 0.5M through to 4.0M ammonia solution. It is believed that when the ratio rose beyond 10 at 2.0M ammonia, the pH (measured at 11.06) of the solution started to rise beyond the predominance region of ammine solutions.

There are other researchers (Osseo-Asare and Feurstenau, 1979, 1980, 1983, 1987; Dyer et al., 2012; Osseo-Asare et al., 1983) who investigated copper, cobalt and nickel loss in ammoniacal solutions. It was reported by researchers (Osseo-Asare and Feurstenau, 1979; Feurstenau and Oseo-Assare, 1987) who investigated cobalt, copper and nickel adsorption onto pre-formed substrates that at pH 9.25 ([NH<sub>3</sub>]:[NH<sub>4</sub><sup>+</sup>]=1), minimum metallic losses are observed and an increase in pH ([NH<sub>3</sub>]:[NH<sub>4</sub><sup>+</sup>])>1 resulted in a rise in metallic losses from solution. Another team of researchers (Dyer et al., 2012) who investigated valuable losses as iron precipitates were forming, reported that minimum cobalt losses are observed at pH 10-10.5 ([NH<sub>3</sub>]:[NH<sub>4</sub><sup>+</sup>] $\approx$ 10). Combining these findings, it can be argued that the range of highest extraction lies in the range between 1 and 10 [NH<sub>3</sub>]:[NH<sub>4</sub><sup>+</sup>]. However, there were more tests performed in this work to confirm these findings.

Figure 4.6(b) does not deviate very far from these above reported observations. At 1.0M ammonia solution concentration, the ratio of ammonia to ammonium ions is 5 and at 2.0M ammonia, the ratio of ammonia to ammonium ions is 10. These are the mixtures where the highest metal extractions are observed. At 4.0M ammonia solution concentration, the ratio of ammonia to ammonium ions is 20 and at that ratio the pH likely favours the corresponding oxides, hydroxides and carbonates according to Figure 2.4. The measured pH of the solution was 9.89 at 0.5M ammonia and 11.06 at 4.0M ammonia.

At 0.2M ammonium carbonate, the extraction efficiency of copper and cobalt was relatively higher over a larger range of ammonia solution concentration because the pH range remained lower than 11. When the concentration of ammonia solution was 0.5M, the measured pH at sampling was 9.89. When the concentration of ammonia solution was 1.0M, the measured pH of the leach solution at sampling was 9.95. Furthermore, when the concentration of ammonia solution was 2.0M, the measured pH at sampling was 10.32. When the concentration of ammonia solution was 4.0M, the pH of the solution at sampling was 11.06.

It can thus be deduced from Equation 2.8 that when the concentration of ammonium carbonate is low relative to the concentration of ammonia solution, the pH will rise beyond the predominance area of ammine complexes at a shorter range than when the concentration of ammonium carbonate is higher in the range of ammonia solution concentrations.

With a trend starting to emerge, the next test was performed at 0.4M ammonium carbonate concentration and the concentration of ammonia solution sequentially altered. Figure 4.6(c) shows the results when this test was performed.

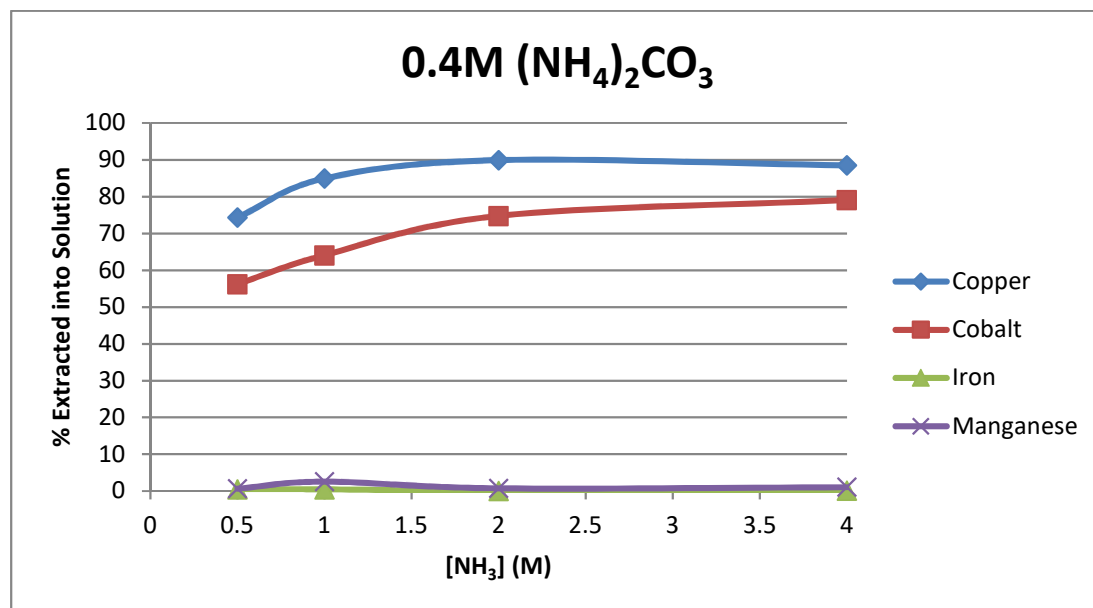

[(NH<sub>4</sub>)<sub>2</sub>SO<sub>3</sub>]: 0.4M; 80°C; 300rpm; -75+63µm; Pre-Treatment Time: 1 hour; Leach Time: 1 hour;

**Fig. 4.6(c): The Effect of Changing Ammonia Solution Concentration at Fixed 0.4M Ammonium Carbonate**

Figure 4.6(c) shows that at 0.4M ammonium carbonate concentration, the extraction efficiency of copper increases and levels-out at 2.0M ammonia where extraction of copper is about 90%. At this ratio of 5, the measured pH of the solution was pH 10.08. There was no significant change of extraction when the concentration of ammonia solution was increased beyond 2.0M.

The extraction efficiency of cobalt increased with increasing ammonia solution concentration and was at its maximum at 4.0M ammonia solution, where the extraction of cobalt was observed at 79%.

It can however, be noted at this early stage that the efficiency of extraction is not just dependent on the concentration ratios of ammonia and ammonium carbonate. If it were the case, the extractions of copper and cobalt at 0.1M  $(\text{NH}_4)_2\text{CO}_3$  and 0.5M  $\text{NH}_3$ ; 0.2M  $(\text{NH}_4)_2\text{CO}_3$  and 1.0M  $\text{NH}_3$  would have been equally high. Figure 4.6(c) shows that when the concentration of ammonium carbonate solution is at 0.4M, concentrating the ammonia solution beyond 2.0M does not significantly improve the extraction of copper and cobalt. There is thus a case to be made that the high extraction of cobalt and copper at 0.4M ammonium carbonate concentration compared to the lesser concentrations of ammonium carbonate reported in Figure 4.4 (a) and 4.4(b) shows that there exists an empirically determinable optimum concentration of the ammonium salt for efficient extraction. Thus the ammonium salt concentration may have a bigger role to play in the leaching of copper and cobalt than just being a pH buffer.

The general trend is the same as the general trend observed in Figure 4.6(b). At 2.0M ammonia and 0.4M ammonia carbonate, copper extraction peaks at about 90%. This was the highest recorded extraction of copper in the entire test of Section 4.5. Cobalt extraction also peaked at 79% at 4.0M ammonia solution.

Following on the conditions set out in Table 3.4, the next test was to investigate the effect of changing the concentration of ammonia solution when the concentration ammonium carbonate is fixed at 1.0M. The results are shown in Figure 4.6(d).

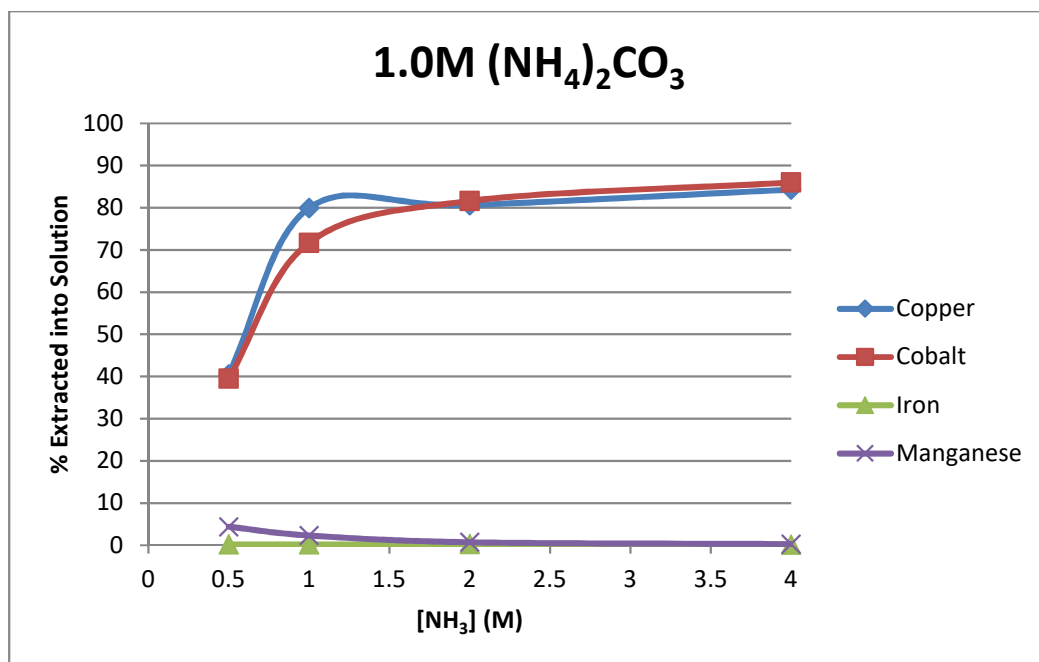

*[(NH<sub>4</sub>)<sub>2</sub>SO<sub>3</sub>]: 0.4M; 80°C; 300rpm; -75+63µm; Pre-Treatment Time: 1 hour; Leach Time: 1 hour;*  
**Figure 4.6(d): The Effect of Changing Ammonia Solution Concentration At Fixed 1.0M Ammonium Carbonate**

Figure 4.6(d) shows that at 1.0M concentration of ammonium carbonate, the high extractions of copper and cobalt are sustained over a longer range of increasing ammonia solution concentrations. At 1.0M ammonium carbonate concentration, the highest extraction of cobalt is observed at 4.0M ammonia concentration, where it is 86%. Furthermore, at 1.0M ammonium carbonate concentration, the highest extraction of copper is also observed at 4.0M ammonia concentration, where it is 84%.

It is worth noting at this point that there exists published work (Das et al., 1986) reported comparable experimental conditions. In the published work (Das et al., 1986), when the effect of ammonia solution was tested, ammonium ions concentration was fixed at 0.37M while ammonia solution concentration was varied from 0.0M to 5.0M. In the current work more ammonia and ammonium carbonate combinations were tested compared to the work by Das et al. (1986).

The next test was with the batch tests set out in Table 3.4 in Section 3.4.4. The concentration of ammonium carbonate was fixed at 2.0M and the concentration of ammonia solution varied from 0.5M to 4.0M. The results of the test are shown in Figure 4.6(e).

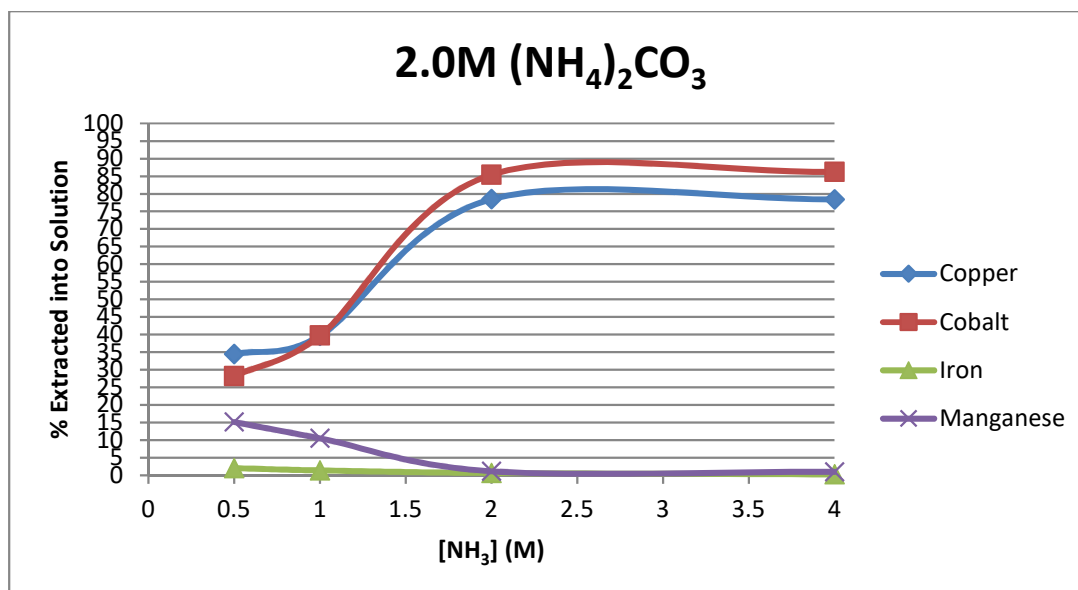

[(NH<sub>4</sub>)<sub>2</sub>SO<sub>4</sub>]: 0.4M; 80°C; 300rpm; -75+63µm; Pre-Treatment Time: 1 hour; Leach Time: 1 hour;

**Fig. 4.6(e): The Effect of Changing Ammonia Solution Concentration at Fixed 2.0M Ammonium Carbonate**

Figure 4.6(e) shows that at 2.0M ammonium carbonate concentration, an increase in the concentration of ammonia solution favours an increase in the extraction of copper and cobalt.

At 2.0M ammonium carbonate, the ratio of ammonia to ammonium carbonate ranged between 0.25 and 2. This means that the higher concentrations of ammonia solution per Equation 2.8 corresponded to the pH reported by Osseo-Asare and Feurstenau, (1979); Dyer et al., (2012) to result in highest extractions (lowest losses).

The extraction of cobalt increased with increasing ammonia concentration up to 2.0M ammonia. At 2.0M ammonia, the extraction of cobalt was 85% and did not significantly change when the concentration of ammonia was raised to 4.0M. This was almost equal to the observed extraction when the ammonium carbonate concentration was 1.0M and the ammonia solution concentration was 4.0M.

The last test performed was at 4.0M ammonium carbonate as the ammonia solution concentration was incrementally changed. The results are shown in Figure 4.6(f).

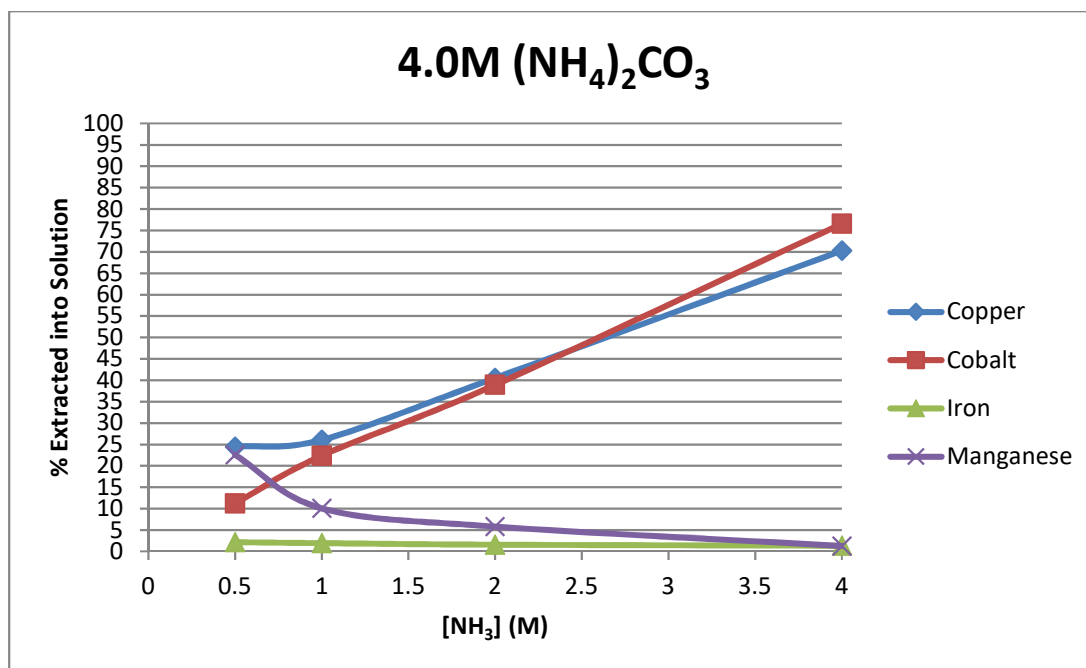

(NH<sub>4</sub>)<sub>2</sub>SO<sub>4</sub>: 0.4M; 80°C; 300rpm; -75+63µm; Pre-Treatment Time: 1 hour; Leach Time: 1 hour;

**Figure 4.6(f): The Effect of Changing Ammonia Solution Concentration at Fixed 4.0M Ammonium Carbonate**

Figure 4.6(f) shows the effect of incrementally changing the concentration of ammonia solution at 4.0M ammonium carbonate concentration. At this concentration, increasing the ammonia solution concentration increases the extraction throughout the selected range of ammonia solution concentrations. At 4.0M ammonium carbonate, the ratio of ammonia to ammonium carbonate was between 0.125 and 1 when ammonia solution concentration was adjusted from 0.5M to 4M.

The highest extraction of cobalt at 4.0M ammonium carbonate concentration was 76% when the ammonia concentration was also 4.0M.

Moreover, the concentration of copper at 4.0M ammonium carbonate was 70% when the ammonia concentration was also 4.0M.

According to equation 2.8 ( $pH = 9.26 + \log \frac{[NH_3]}{[NH_4^+]}$ ), increasing the concentration of ammonia solution while keeping the concentration of ammonium carbonate constant, increases the pH of the solution. Conversely, increasing the concentration of ammonium carbonate while keeping the concentration of ammonia solution constant, decreases the pH of the solution. According to thermodynamic data cited Figure 2.4 and reported research work (Welham et al., 2015; Dyer et al., 2012; Feurstenau and Osseo-Asare, 1987) there exists a limited range of pH within which ammine complexes of copper and cobalt are stable and predominant over copper and cobalt hydroxides and oxides. Thus, in a concentration of an unoptimised pH buffer (See Figure 2.4 and Section 2.7) the pH of the leaching solution can be either too acidic (reduced ammonia solution concentration) or too basic (excessive ammonia solution concentration) to form stable ammine complexes.



In summary, Figures 4.6(a)-(f) show the inter-dependence of ammonia and ammonium carbonate on the efficiency of leaching. When the concentration of ammonium carbonate was fixed at 0.1M increasing the concentration of ammonia solution decreased the efficiency of extraction. It is believed that the resultant rise in pH reached a region favouring the predominance of oxides, hydroxides and carbonates as opposed to the more aqueous soluble ammine complexes. However, as the concentration of ammonium carbonate is increased further, a larger range of peak extractions is observed with an increase in the concentration of ammonia solution. It was further observed that in most tested reaction conditions, increasing the concentration of ammonia solution beyond 2.0M did not result in a significant increase in valuable metal extraction.

Thermodynamic data shown in Figure 2.4 shows that there is a range of pH within which copper and cobalt amines will be stable and predominant. Outside of that pH range, species like oxides, hydroxides and carbonates preferentially form over the aqueous soluble ammine complexes. These species tend to precipitate from aqueous solution and are thus, associated with the reduced metal extraction into solution. Furthermore, published research work on copper and cobalt losses in ammoniacal solutions (Dyer et al., 2012; Feurstenau and Osseo-Asare, 1987; Osseo-Asare and Feurstenau, 1979; Osseo-Asare et al., 1983) shows that adsorption of dissolved ammine species on solid substrates; whether the solids are pre-formed (Feurstenau and Osseo-Asare, 1987; Osseo-Asare et al., 1983) or the solids are precipitating as the solution is being generated, (Dyer et al., 2012; Osseo-Asare and Feurstenau, 1979) is inter alia a function of the pH of the solution, the metal in solution and the substrate. The substrate in the current work being silica (determined to be crystalline quartz by XRD), it is therefore believed that further work on this resource should prioritise pH control to ensure high metal extraction. In this work, the pH was measured during sampling due to fears of losing precious ammonia fumes. It is recommended that further work on this resource entail real time pH monitoring and means of adding ammonia and/or the ammonium salt to control the pH to between 9.5 and 10.5.

Figures 4.6 (a)-(f) show the crucial effect of pH on the efficiency of extraction of copper and cobalt in ammine solutions. Measured metal extraction values were highest in the range pH 9.3-10.32. When the pH was below 9.32 and above 11 lowest extractions were reported.

The highest extraction of copper was observed when the reaction conditions were 2.0M ammonia solution and 0.4M ammonium carbonate where copper extraction was 90%.

The highest extraction of cobalt was observed when the reaction conditions were at 4.0M ammonia solution and 2.0M ammonium carbonate where the extraction was 86%. This extraction was however, not significantly different from when the mixture was 1.0M  $(\text{NH}_4)_2\text{CO}_3$ :4.0M  $\text{NH}_3$  and 2.0M  $(\text{NH}_4)_2\text{CO}_3$ :2.0M  $\text{NH}_3$  which were both >85%.

This data can be presented as separate figures for copper and for cobalt to show the optimum concentrations of copper and cobalt on one plane. The illustration for copper is shown in Figure 4.6(g).

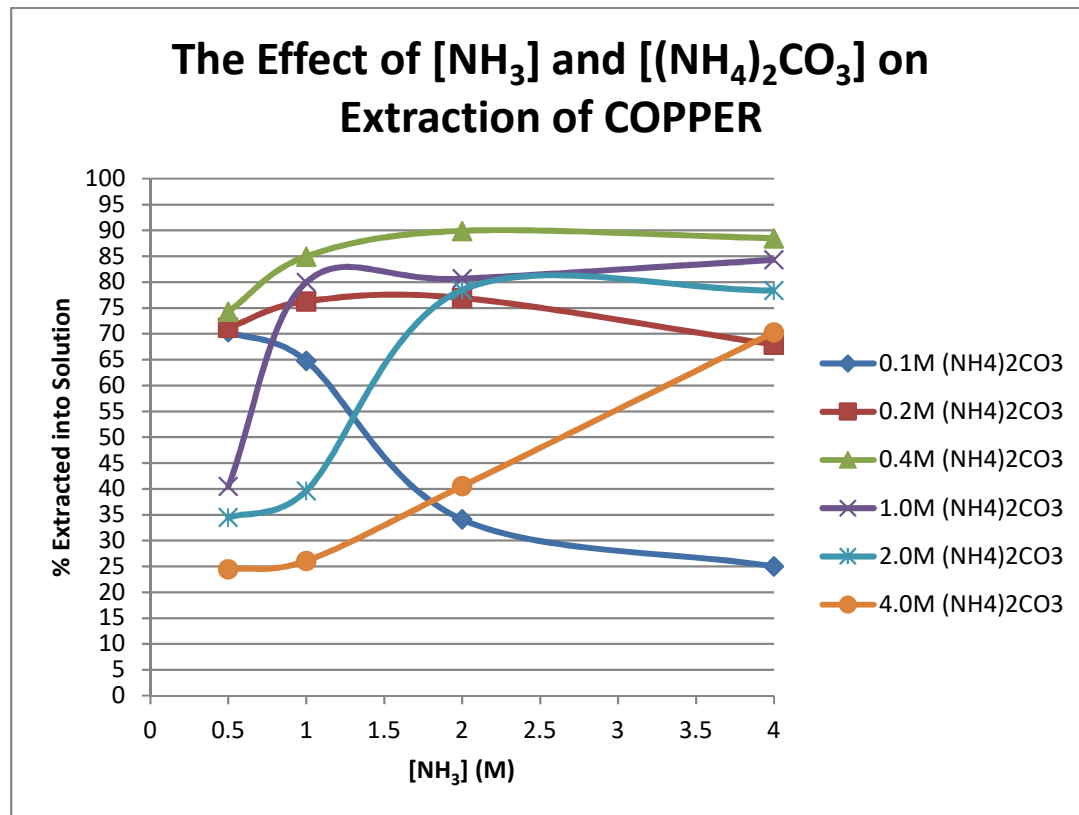

*(NH<sub>4</sub>)<sub>2</sub>SO<sub>3</sub>]: 0.4M; 80°C; 300rpm; -75+63µm; Pre-Treatment Time: 1 hour; Leach Time: 1 hour;*  
**Figure 4.6(g): The Effect of Ammonia Solution and Ammonium Carbonate on extraction of Copper**

Figure 4.6(g) shows the inter-dependence of the ammonia solution and ammonium carbonate concentrations on the efficiency of copper extraction. It is a summary of Figures 4.6(a) to 4.6(f) and shows that the best copper extraction is achieved at 0.4M ammonium carbonate concentration and 2.0M ammonia solution concentration. At this mixing ratio, the measured pH of the solution at sampling was pH 10.08 and copper extraction at about 90%.

It can also be noted from Figure 4.6 (g) that with the exception of 4.0M ammonium carbonate, increasing the concentration of ammonia solution beyond 2.0M does not result in increased copper extraction. It can further be noted that increasing the concentration of ammonium carbonate beyond 0.4M did not improve the extraction of copper.

A summarised graph on the effect of the concentration of ammonia solution and ammonium carbonate on the extraction of cobalt is shown in Figure 4.6(h).

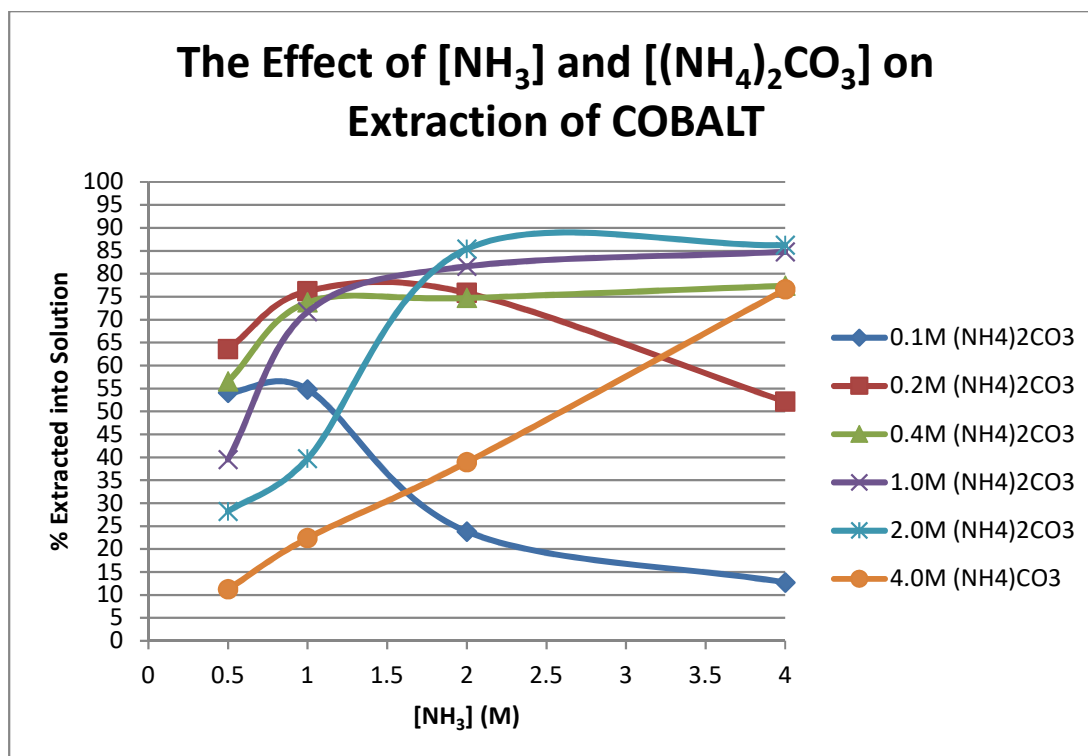

$(\text{NH}_4)_2\text{SO}_3$ : 0.4M; 80°C; 300rpm; -75+63 $\mu\text{m}$ ; Pre-Treatment Time: 1 hour; Leach Time: 1 hour;

Figure 4.6(h): The Effect of Ammonia Solution and Ammonium Carbonate on Extraction of Cobalt

Figure 4.6(h) shows that the highest extraction of cobalt of 86% occurred when the mixture was 4.0M ammonia and 2.0M ammonium carbonate. This was practically equal to the extraction at 1.0M ammonium carbonate and 4.0M ammonia and also not significantly greater than the extraction at 2.0M ammonium carbonate and 2.0M ammonia. A case can then be made that the best cost/value compromise would be 2.0M ammonia solution and 2.0M ammonium carbonate which resulted in extraction of approximately 85% cobalt.

Under these conditions the measured pH was 9.29 and the potential was -106mV. At this potential, some of the manganese will be in solution as per thermodynamic and empirical data. The manganese removal can be effected by aerating the solution to oxidise the manganese out of solution. A mixture of air and sulphur dioxide is sometimes used for oxidation in copper-cobalt treatment and recovery and can be used in this instance as well. The advantage of oxidising manganese to reject the manganese out of solution is that the trivalent cobalt ammine complex is stable and remains in solution. However, if manganese extraction can be kept low by controlling the potential (by monitoring and addition of reducing agent or oxidising agent) to between 0.0V and 0.25V, the co-extracted manganese can be rejected or kept at sufficiently low concentrations as not to pose problems in cobalt recovery because manganese does not co-deposit with cobalt (Crundwell et al., 2011).

## Summary

XRF analysis showed that the ore was a reasonably potentially profitable high grade resource. Furthermore, through XRF analysis it was discovered that the -75 $\mu$ m size fraction reported the highest copper and cobalt concentrations at 8.02% copper and 0.88% cobalt. For this reason, it can be argued that it is not necessary to incur the costs of milling the ore any finer than 63 $\mu$ m in practice.

In summary, the tests carried out investigated first the reducing agent concentration followed by the temperature, the particle size distribution and lastly the concentration of the individual concentrations of the ammonia-ammonium carbonate concentrations.

The first test investigating the effect of a reducing agent was performed. A sequential range of reducing agent concentration of between 0.0M and 0.1M was evaluated at ambient temperature and the results were inconclusive. The results showed poor extraction of copper and cobalt. It was suspected that the poor extraction was due to either low temperature or the low concentration of the reducing agent used during the experiment. To test both hypotheses, another leaching test was performed where the lixiviant was kept at the same initial concentrations but the temperature was raised to 60°C. There was a significant rise in the extraction of copper and cobalt when the temperature was raised. At ambient temperature, cobalt extraction did not exceed 5% but rose to about 30% when the temperature was raised to 60°C. At ambient temperature, copper extraction did not exceed 30% but rose to greater than 80% when the temperature was raised to 60°C.

Extraction in the supplementary test thus confirmed the importance of temperature. A further supplementary test at the elevated temperature and increased concentration of reducing agent was also carried out. The results therefrom did not show a distinct trend that was useful going forward. The results of these tests were however, marred by the leaching procedure and logistics. It was suspected that frequent periodic sampling which entailed *inter alia* repeatedly depressurising the sealed leaching vessel led to ammonia losses through fumes. Moreover, the process of filtration left the solution depressurised and prone to ammonia losses and reduced solution temperature. Lastly, the pregnant leach solution samples had to be kept in storage that could not maintain leaching conditions for periods between 12 hours and 5 days depending on the scheduling situation for AA analysis. This led to the first suspicion that the leaching procedure needed to be optimised to give more reliable trends and to make the leached samples more resilient to storage effects.

The next test was carried out to investigate the effects of raising the temperature. The temperature range was between ambient temperature and 80°C. The results showed that copper extraction peaked and plateaued at 40°C through to 60°C. The extraction of copper showed significant reduction when the temperature was raised further to 80°C.

The results further showed that cobalt extraction improved with increased temperature and was at its highest at 60°C. Raising the temperature to 80°C significantly reduced the extraction of cobalt as well.

This reduced extraction of copper and cobalt at 80°C was attributed to the significant ammonia losses observed as violent effervescence and foggy fuming when the solution was depressurised as sampling was effected. These observations further corroborated the arguments that the sampling procedure needed to be improved.

The next test was carried out to investigate the effect of particle size distribution on extraction efficiency. The basic elementary hypothesis of this test was that it is easier to extract finer particles into solution than coarser particles. The objective of the test was to investigate whether the anticipated ease of extraction would translate to more copper and cobalt extracted into solution. As such, the aim of the test was to determine the coarsest particle size representing the best cost/value compromise that would result in relatively high extraction efficiency because it was noted that fine to ultra-fine milling increases processing costs. The results of this test showed that no significant improvement in extraction efficiency for copper and cobalt are realised by milling finer than 63µm. It was further noted that in actual plant practice, milling to -75µm would encompass particles sized 53µm, 38µm and even finer. There would be none of the bench-scale size fractions where the investigated fraction was restricted to finer than 75µm but coarser than 63µm.

At this stage of test work, it had become apparent an improved leaching regime was necessary. The optimised leaching regime was to simultaneously attempt to address the relatively poor extraction possibly caused by the cumulative effects of low temperature; unleached cobalt remaining in the residue; cobalt precipitating on filter paper and ammonia losses to fumes. The procedure further aimed at making the pregnant leach solution samples more resilient to storage. The optimised leaching regime incorporated the pre-treatment method and using dilute hydrochloric acid as the diluent as opposed to deionised water. It further eliminated periodic sampling and enabled circumventing filtration. The optimised leaching procedure was tested and resulted in notable increased extraction for both copper and cobalt. The leaching procedure was further followed when investigating the effects of ammonia solution and ammonium carbonate concentrations. The leaching procedure is discussed in Section 3.5 and 3.6 and illustrated in Figure 3.2(b).

The last test was to investigate the effect of the concentration of the ammonia and ammonium carbonate. The test was carried out following the optimised leaching flow sheet illustrated in Figure 3.2(b). The results therefrom show that there are different solution mixtures that result in the highest copper and cobalt extractions. The NH<sub>3</sub>-NH<sub>4</sub><sup>+</sup> mixture resulting in the highest copper extraction was 2.0M NH<sub>3</sub> and 0.4M (NH<sub>4</sub>)<sub>2</sub>CO<sub>3</sub> at 90%. Unlike with copper, several mixtures resulted in reasonably similar extraction of >85%. These were 1.0M (NH<sub>4</sub>)<sub>2</sub>CO<sub>3</sub>-4.0M NH<sub>3</sub>; 2.0M (NH<sub>4</sub>)<sub>2</sub>CO<sub>3</sub>-2.0M NH<sub>3</sub> and 2.0M (NH<sub>4</sub>CO<sub>3</sub>)-4.0M NH<sub>3</sub>. For cobalt, the midway

cost/value compromise for the highest extraction was believed to be 2.0M NH<sub>3</sub> to 2.0M (NH<sub>4</sub>)<sub>2</sub>CO<sub>3</sub>.

It was also found in this test work that increasing the reducing agent concentration decreased copper extraction but increased cobalt extraction. This means that copper from this resource is best leached in the absence of a reducing agent while cobalt from this resource is best leached in the presence of a reducing agent. These diametrically opposed characteristics of copper and cobalt leaching lead to a suggestion that in practice, the leaching needs to be carried out in two stages.

It is recommended that the first step involve leaching of the material at 80°C; 0.4M (NH<sub>4</sub>)<sub>2</sub>CO<sub>3</sub> and 2.0M NH<sub>3</sub> in the absence of a reducing agent. From the experiments conducted, this approach should extract most of the copper into solution and leave most of the cobalt in the residue. The leach solution should then be filtered and the residue therefrom sent to the next stage of ore pre-treatment in a reducing agent. The pregnant leach solution will then be treated for copper recovery using solvent extraction and electrowinning. The raffinate solution from the copper solvent extraction unit can then be mixed with further ammonia-ammonium carbonate solution to correct the solution to 2.0M (NH<sub>4</sub>)<sub>2</sub>CO<sub>3</sub> and 2.0M NH<sub>3</sub> and be used in the leaching of the cobalt.

Another finding of the work was the ease at which copper was leached relative to cobalt. The ease of leaching of copper can be explained by discussing the mineral phase analysis of the ore material. Malachite, which is a known copper mineral, was found to be a discrete phase in the ore, which eased its leaching as the lixiviant interacted directly with it. There was no known cobalt-bearing mineral identified in the mineral phase analysis. Assuming the accuracy of the analysis, this means that the cobalt is intimately and chemically associated with another phase and requires separation therefrom before being extracted into solution. However, another possibility could be that copper and cobalt follow different mechanisms in order to form stable ammine complexes. That possibility being that the cobalt can only form cobalt ammine complexes when it is already in solution. i.e. solid trivalent compounds of cobalt react very slowly with ammonia.

It is suggested that further work on this resource pertaining to leaching in ammonia first ascertain the mineral phase in which cobalt occurs in this ore. This will determine if the release of cobalt is the bottleneck in the leaching of cobalt in ammonia or if the cobalt necessarily needs to be divalent to be extracted into solution. Further work on this resource can investigate the kinetics of forming cobalt ammine solutions from trivalent cobalt compounds like analytical reagent grade cobalt (III) oxide (Co<sub>2</sub>O<sub>3</sub>) and even mixed valence cobalt oxide (Co<sub>3</sub>O<sub>4</sub>). Findings of such work would possibly provide a more detailed argument for why reductive leaching in ammoniacal solutions is required even though thermodynamic data states that the trivalent cobalt ammine complex is stable in solution at basic pH.

The recommended further work notwithstanding, it is important to report the findings of the current work. As such, according to the findings of the current work, the flow sheets in Figures 2.1(a) and 2.1(b) cited herein can be altered to follow the flow sheet in Figure 4.7 to maximise extraction of copper and cobalt in accordance with the findings of this work.

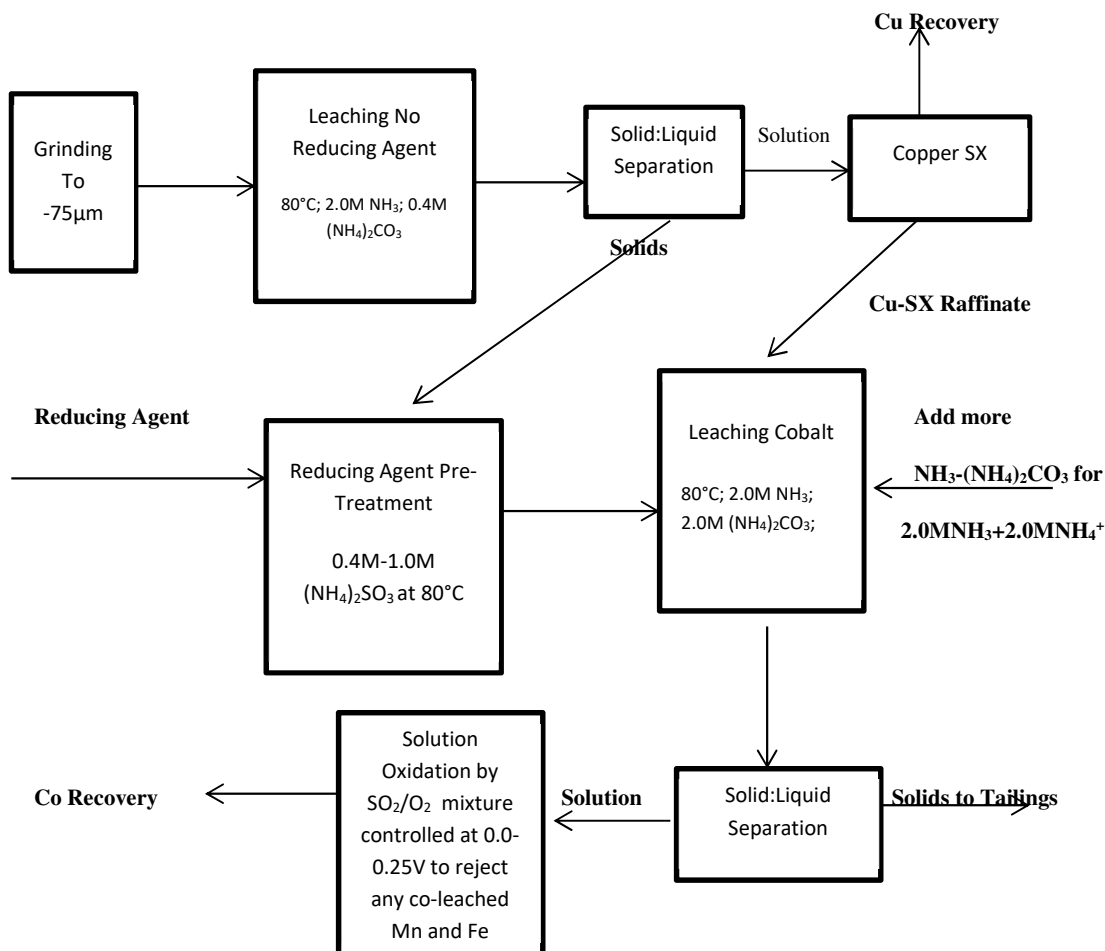

Figure 4.7: Proposed Flow sheet for Leaching the Resource as per Findings

As already argued in earlier paragraphs, the possible causes of the low extraction of cobalt were discussed. Firstly, it was possible that the cobalt remained in the residue after leaching, hence necessitating pre-treatment. The other possible losses of cobalt were addressed by eliminating periodic sampling and filtration so as to ensure that the ammonia remains sealed and does not escape from the leaching vessel as well as storing the solution as a clear chloride solution as opposed to the indigo-blue ammine solution.

The separate copper and cobalt leaching are to address the finding that copper leaches best in the absence of a reducing agent and cobalt requires a reducing agent for high extraction. The additional ammonium carbonate into the cobalt leach is because the mixing ratios for best copper and cobalt extractions are different with copper best leached in 0.4M ammonium carbonate solution and 2.0M ammonia solution while

cobalt is best leached in 2.0M ammonia solution and 2.0M ammonium carbonate solution. Thus according to the findings of this work, the leaching flow diagram in Figure 4.7 should theoretically result in the best copper and cobalt extractions.



# Chapter 5

## Conclusions and Recommendations

The aim of the work was to investigate the viability of ammoniacal leaching as an alternative to the established sulphuric acid leaching for the extraction of copper and cobalt from a copper-cobalt oxide ore. This work reports the direct leaching of a copper-cobalt oxide ore using ammonia solution and ammonium carbonate as the lixiviant and ammonium sulphite as a reducing agent. XRF analysis performed on different size fractions of the ore determined that the ore grade ranges between 5% to 8% copper and between 0.44%-0.88% cobalt.

The effect of the concentration of a reducing agent, the effect of temperature, the effect of particle size and the effect of the concentrations of ammonia solution and ammonium carbonate were investigated for their ability to maximise copper and cobalt extraction while minimising iron and manganese extraction. It can be concluded that ammoniacal solution is indeed a viable alternative to sulphuric acid in the hydrometallurgical processing of this ore.

### 5.1. The Effect of Reducing Agent Concentration

Increasing the reducing agent concentration increases cobalt extraction and reduces copper extraction. The highest copper extractions were observed when there was no reducing agent used while the best extractions of cobalt were observed at concentrations of at least 0.4M. Therefore, subsequent tests were carried out at 0.4M ammonium sulphite and extractions of >80% for copper were observed in most tests. In the absence of a reducing agent, copper extractions of >90% were realised prompting the suggestion of the use of a multi-step leaching process in order to maximise copper and cobalt extractions.

### 5.2. The Effect of Temperature

In the initial experiments, the best extractions of copper and cobalt were observed at 60°C. Moreover, in the initial experiments, there was significant decrease of extraction of copper and cobalt recorded when temperature was increased to 80°C. The reason for this reduced extraction was attributed to losses of ammonia to fumes when the leach vessel was unsealed for sampling and the rapid loss of hot ammonia from filter paper when the pregnant leach solution sample was filtered. To assess these suspicions, leaching was performed continuously at 80°C for 60 minutes without half-hourly sampling to prevent these observable losses of ammonia. When leaching was performed continuously for 60 minutes at 80°C without repeatedly unsealing the

vessel to undertake half-hourly sampling, extraction of copper and cobalt was greater than when leaching was carried-out at 60°C. It can thus be concluded that the best extraction of copper and cobalt was recorded when leaching at 80°C.

### **5.3. The Effect of Particle Size**

The results in this study showed that the extraction of copper was not significantly affected by the particle size of leaching, with extraction remaining around 80% throughout the tested particle size ranges. Cobalt extraction was however, slightly affected. Extraction was noted to increase from 33% at -75µm to 37% at -38µm. It can therefore, be concluded that there is no significant extraction advantage caused by milling finer than -75+63µm. Moreover, XRF analysis performed on the different size classes of the ore determined there is highest metal content in the -75 µm fraction of the ore. Therefore, all other subsequent tests were performed using the -75+63µm fraction of the ore. It was further noted that in plant practice, milling to -75µm would encompass all particles finer than 75µm. These include the -53µm and -38µm particle sizes, and would not be limited to the bench-scale particle size fraction that was limited to finer than 75µm and coarser than 63µm for the purposes of the test.

### **5.4. The Effect of the Concentrations of Ammonia Solution and Ammonium Carbonate**

The objective of this test was to determine the best mixing ratio of the ammonia-ammonium carbonate lixiviant that would result in the best extractions of copper and cobalt and the minimum extraction of manganese and iron into solution.

The highest extraction of copper at 90% was observed at 2.0M ammonia solution and 0.4M ammonium carbonate. This was achieved after the incorporation of pre-treatment which had largely been abandoned in earlier tests. Pre-treatment was reinstated into the methodology after pre-treated material in the optimised tests gave favourable results. The material was thus pre-treated with 0.4M ammonium sulphite at 80°C for 60 minutes followed by leaching in ammoniacal solution at 80°C for another 60 minutes at 300rpm.

The highest extractions of cobalt were observed at three mixing ratios. These were 1.0M (NH<sub>4</sub>)<sub>2</sub>CO<sub>3</sub> : 4.0M NH<sub>3</sub>; 2.0M (NH<sub>4</sub>)<sub>2</sub>CO<sub>3</sub> : 2.0M NH<sub>3</sub> and 2.0M (NH<sub>4</sub>)<sub>2</sub>CO<sub>3</sub> : 4.0M NH<sub>3</sub> where the extraction of cobalt was greater than 85%.

The samples were stored prior to analysis as chlorides (diluted in HCl) and analysed as chlorides.

It can be concluded that copper and cobalt can viably be processed and recovered by hydrometallurgical extraction processing using ammoniacal solution. However, a precaution that needs to be taken is that the leach vessel needs to remain sealed to accomplish high extraction of the value metals. Therefore, any action that causes premature depressurising of the vessel needs to be avoided.

As this work sought to investigate the viability of ammoniacal solution as a lixiviant at plant scale, leaching the resource can be performed in agitated pressure leaching equipment which is already used in acid leaching. In the event that acid leaching becomes impracticable, the same equipment used in acid leaching can be used for ammoniacal leaching.

### **5.5. Recommendations**

For further work on this resource, there are two questions that need to be answered. Firstly there should be a clear answer as to why it is necessary to subject the cobalt in this ore to reduction when trivalent cobalt ammine complex is thermodynamically stable and predominant.

This can be achieved by determining the mineral phase in which cobalt is found in this ore. It can then be determined whether the reduction has the effect of releasing the cobalt from its associations or whether it is a requirement for the cobalt to be divalent for it to be leached in ammoniacal solution. Further work to achieve this end can be performed by investigating the viability of leaching cobalt from laboratory reagents of trivalent cobalt (e.g.  $\text{Co}_2\text{O}_3$ ) and mixed valence cobalt (e.g.  $\text{Co}_3\text{O}_4$ ) in ammonia. If the pure trivalent and mixed valence cobalt compounds can be readily dissolved into ammoniacal solution without reduction, it would suffice to argue that the reduction is required to separate the cobalt from its intimate associations. However if extraction remains poor in the absence of reduction, it can thus be argued that it is a requirement that the cobalt be divalent for it to dissolve in ammoniacal solution. Such work would lay the matter to rest as to why the cobalt in the Katanga ore needs to be subjected to reduction prior to leaching in ammoniacal solution.

Moreover, having determined that contacting the ore with a reducing agent prior to leaching and then leaching the ore in a sealed vessel while making sure to eliminate all processes that depressurise the system improves extraction, it may be necessary to investigate any improvements that can optimise this process further.

Having determined that ammoniacal solution leaching can be used as a viable alternative to sulphuric acid leaching, more work on this resource can be done to actually compare the lixiviants. The work can generate empirical data that compares the ease of use of each of the lixiviants, running costs of using both, the ergonomics of using either sulphuric acid or ammoniacal solution and other parameters that can help determine which of the two leaching solutions would be the best cost/value/convenience compromise in application. Although this work is founded upon the relative shortcomings of leaching in sulphuric acid against the relative advantages of leaching in ammonia, some plants that have successfully used sulphuric acid might require further convincing of the advantages of ammonia solution. This can only be achieved by doing work that compares sulphuric acid and ammoniacal solution directly.

Furthermore, when comparing the lixivants, extended work can be done to determine the best cost/value/convenience compromise when leaching continues to metal recovery. This work can investigate *inter alia* valuable losses when generating electrowinning advance electrolytes for copper and cobalt from both sulphuric acid and ammoniacal solution leaching.

# References

- Achandrya, S. and Das, R.P. (1987). Kinetics and Mechanism of the Reductive Ammonia Leaching of Ocean Nodules by Manganous Ions. *Hydrometallurgy* 19 Elsevier Science Publishers B.V., Amsterdam pp. 169-186.
- Apua, M. C. and Mulaba-Bafubiandi, A.F. (2011). Dissolution of oxidised Co–Cu ores using hydrochloric acid in the presence of ferrous chloride. *Hydrometallurgy* 108. Elsevier Science.
- Biernat, R.J. And Robins, R.G. (1969). High Temperature Potential/pH Diagrams for the Sulphur-Water System. *Electrochimica Acta* 14. Pergamon Press, Dublin. Accessed at [http://ac.els-cdn.com/0013468669870039/1-s2.0-0013468669870039-main.pdf?\\_tid=01df3150-ab64-11e6-b5e4-00000aab0f26&acdnat=1479235849\\_a8c12c482333203895f82496e2dcf48c](http://ac.els-cdn.com/0013468669870039/1-s2.0-0013468669870039-main.pdf?_tid=01df3150-ab64-11e6-b5e4-00000aab0f26&acdnat=1479235849_a8c12c482333203895f82496e2dcf48c) on 15 November 2016.
- Boland, M.A. and Kropschot, S.J. (2011). “Cobalt-For Strength and Colour.” United States Geological Survey Fact Sheet 3081-2011 accessed at <http://pubs.usgs.gov/fs/2011/3081/pdf/fs2011-3081.pdf> on 30 June 2015.
- Cailteux, J.L.H.; Kampunzu, A.B.; Lerouge, C.; Kaputo, A.K.; Milesi, J.P. (2005). Genesis of sediment-hosted stratiform copper–cobalt deposits in the Central African Copperbelt. *Journal of African Earth Sciences* 4. pp. 134–158.
- Crundwell, F; Moats, M; Ramachandran, V. and Davenport, W.G. (2011). *The Extractive Metallurgy of Cobalt, Nickel and Platinum Group Metals*. Elsevier Science. Saint-Louis, MO. pp 362-391.
- Das, R.P; Anand, S; Das, S.C; and Jena, P.K. (1986). Leaching of Manganese Nodules in Ammoniacal Medium Using Glucose as Reductant. *Hydrometallurgy* 16 pp. 335-344.
- Davenport, W.G; King, M; Schlesinger, M and Biswas, M. (2002). *Extractive Metallurgy of Copper* Fourth Edition. Elsevier Science. Kindlington, Oxford pp. 17-29.
- Dewaele, S.; Muchez, Ph.; Vets, J.; Fernandez-Alonzo, M.; Tack, L. (2006). Multiphase origin of the Cu–Co ore deposits in the western part of the Lufilian fold-and-thrust belt, Katanga (Democratic Republic of Congo). *Journal of African Earth Sciences* 46. Pp. 455–469.
- Doeblich, J. and Masonic, L (2009): “Copper a metal for the ages.” United States Geological Survey Fact Sheet 2009-3031. Accessed at <http://pubs.usgs.gov/fs/2009/3031/FS2009-3031.pdf> on 1<sup>st</sup> November 2016.

Dyer, L; Su, B; and Asselin, E. (2012). Cobalt Loss Due to Iron Precipitation in Ammoniacal Carbonate Solutions. *Hydrometallurgy* 125 pp. 144-147.

Ferron, C.J. (2008). Sulfur Dioxide: A Versatile Reagent for the Processing of Cobaltic Oxide Minerals. *JOM* Volume 60 No. 10.

Fisher, K.G. (2011). Cobalt Processing Developments. SAIMM. Paper presented at 6<sup>th</sup> Southern African Base Metals Conference, Phalaborwa, Republic of South Africa.

Fuerstenau, D.W and Osseo-Asare, K. (1987). Adsorption of Copper, Nickel and Cobalt by Oxide Adsorbents from Aqueous Ammoniacal Solutions. *Journal of Colloidal and Interface Science* Volume 118 No. 2 pp. 524-542.

Georgiou, D.; Papangelakis, V.G. (2009). Behaviour of cobalt during sulphuric acid pressure leaching of a limonitic laterite. *Hydrometallurgy* 100. Elsevier Science pp. 35–40.

Georgiou, D. and Papangelakis, V.G. (1998) Sulphuric Acid Pressure Leaching of a Limonitic Laterite: Chemistry and Kinetics. *Hydrometallurgy* 49 Elsevier Science. pp. 23–46.

Guo, X.; Shi, W.; Li, D.; Tian, Q. (2011). Leaching behaviour of metals from limonitic laterite ore by high pressure acid leaching. *Transactions of Non-Ferrous Metals Society of China* 21. pp. 191-195.

Han, K.N; Hoover, N; and Feurstenau, D.W. (1974). Ammonia-Ammonium Leaching of Deep Sea Manganese Nodules. *International Journal of Mineral Processing*. Elsevier Scientific Publishing Company, Amsterdam.

Kim, D.J.; Chung, H.S.; and Yu, K. (2002). Cobalt Powder from  $\text{Co}(\text{OH})_2$  by Hydrogen Reduction. *Materials Research Bulletin* 37. Pergamon Press & Elsevier Science, Amsterdam.

Kyembo, D.M. (2015). The Separation of Cobalt from Copper-Cobalt Ore Leach Solutions using Solvent Extraction. MSc. (Eng.) Dissertation. University of Witwatersrand, Johannesburg.

Moore, J.J. (1981). *Chemical Metallurgy*. Butterworths. London. pp. 286-293.

Moore, J.J. (1990). *Chemical Metallurgy* Second Edition. Butterworth-Heinemann. Oxford. pp.266-268.

Munnik, E.; Singh, H.; Uys, T; Bellino, M. J; du Plessis, M.; Fraser, M. K and G.B. Harris (2003). Development and implementation of a novel pressure leach process for the recovery of cobalt and copper at Chambishi, Zambia. *The South African Institute of Mining and Metallurgy*, 2002. SA ISSN 0038–223X/3.00 +

Mwema, M.D.; Mpoyo, M.; and Kafumbila, K. (2002). Use of sulphur dioxide as reducing agent in cobalt leaching at Shituru hydrometallurgical plant. The South African Institute of Mining and Metallurgy, 2002. SA ISSN 0038–223X/3.00.

Nakazawa, H.; Sato, H. (1995). Bacterial Leaching of Cobalt-rich Ferromanganese Crusts. *International Journal of Mineral Processing* 43 pp. 255-265.

Niinae, M; Nakahiro, Y; Wakamatsu T. and Shibata, J. (1994). Preferential Leaching of Cobalt, Nickel and Copper from Cobalt Rich Ferro-Manganese Crusts with Ammoniacal Solutions using Ammonium Thiosulphate and Ammonium Sulphite as Reducing Agents. *Hydrometallurgy* 40 pp. 111-121.

Osseo-Asare, K. and Fuerstenau, D.W., (1980). Adsorption phenomena in hydrometallurgy, 3. Model for copper, nickel and cobalt uptake by oxide adsorbents in aqueous ammoniacal solutions. *International Journal of Mineral Processing* 7: 219-234.

Osseo-Asare, K; Lee, J.W; Kim, H.S. and Pickering, H. W. (1983). Cobalt Extraction in Ammoniacal Solution Electrochemical Effect of Metallic Iron. *Metallurgical Transactions B Volume 14B* pp. 571-576.

Osseo-Asare, K. and Fuerstenau, D.W. (1979). Adsorption phenomena in hydrometallurgy, 1. The uptake of copper, nickel and cobalt by oxide adsorbents in aqueous ammoniacal solutions. *International Journal of Mineral Processing* 6: 85-104.

Oxley, A., and Barcza, N. (2013). Hydro–pyro integration in the processing of nickel laterites. *Minerals Engineering* 54.

Prasad, M.S. (1989). Production of Copper and Cobalt at Gecamines, Zaire. *Minerals Engineering*, Vol. 2, No. 4, pp. 521-541. Pergamon Press, Great Britain.

Schlesinger, M.E.; King, M.J.; Sole, K.C.; Davenport, W.G. (2011). *Extractive Metallurgy of Copper Fifth Edition*. Elsevier Science. Amsterdam.

Senanayake, G.; Childs, J.; Akerstrom, B.D.; Pugaev, D. (2011). Reductive acid leaching of laterite and metal oxides — A review with new data for Fe(Ni,Co)OOH and a limonitic ore. *Hydrometallurgy* 110. pp.13-32.

Sharma, I.G.; Alex, P.; Bidaye, A.C.; Suri, A.K. (2005). *Electrowinning of Cobalt from Sulphate Solutions*. Hydrometallurgy 80. Elsevier Science. Amsterdam.

Singh-Gaur, R.P. (2012). Hydrogen Reduction of Heterogenite to Make Sub-Micron Cobalt Metal Powder for Hard Metal Applications. *International Journal of Refractory Metals and Hard Materials* 35. Elsevier Science, Amsterdam.

South African Government (2005). The Petroleum Products Act No. 120 of 1977, Gazette No. 28191 of 4 November 2005 Regulation Gazette No. 3842.

South African Government (2006). The Petroleum Products Act No. 120 1977. Gazette No. 28958 of 23 June 2006. Regulations Regarding Petroleum Products Specifications and Standards.

Thobejane, J.L.; Ndlovu, S. (2016). Leaching of Copper-Cobalt Oxide Ores in Ammonia Solution. Final Year Undergraduate Dissertation, University of Witwatersrand, Johannesburg.

Vu, C.; Han K.N. and Lawson, F. (1980). Leaching Behaviour of Cobaltous and Cobalto-Cobaltic Oxides in Ammonia and in Acid Solutions. *Hydrometallurgy* 6 pp.75-87.

Warner, A.E.M.; Díaz, C.M.; Dalvi, A.D.; Mackey, P.J.; and Tarasov, A.V. (2006). JOM World Nonferrous Smelter Survey Part IV: Nickel: Laterites. *JOM*, April 2006.

Warner, A.E.M.; Díaz, C.M.; Dalvi, A.D.; Mackey, P.J.; Tarasov, A.V.; and Jones, R.T. (2007). JOM World Nonferrous Smelter Survey Part IV: Nickel: Sulfide. *JOM*, April 2007.

Welham, N. J.; Johnston, N. J. and Sutcliffe, M. L. (2015). AmmLeach®-A New Paradigm in Copper–Cobalt Processing. Paper Presented at the 8<sup>th</sup> Southern African Base Metals Conference, Livingstone, Republic of Zambia.

Xu, Y; Xie, Y; Yan, L. and Yang, R. (2005). A New Method For Recovering Valuable Metals from Low-Grade Nickeliferous Oxide Ores. *Hydrometallurgy* 80 pp. 280-285.



# Appendices

## Appendix 1: The effect of reducing agent concentration on leaching

Tables 1(a)-1(f) show leaching results to determine extraction efficiency of the ammonia/ammonium carbonate solution when the concentration of reducing agent is altered.

**Table 1(a) Preliminary Experiments of The Effect of Reducing Agent on Leaching with no reducing agent**

Time (mins)	[Co] (ppm)	Co Ext. (%)	[Fe] (ppm)	Fe Ext. (%)	[Cu] (ppm)	Cu Ext. (%)	[Mn] (ppm)	Mn Ext. (%)
30	36.934	4.17300798	5.939	0.243401639	172.31	53.70145816	4.202	1.448
60	16.081	1.816920489	2.549	0.104467213	59.392	18.50987757	1.226	0.422
90	20.974	2.369758742	7.719	0.316352459	64.66	20.15168176	2.71	0.934
120	15.683	1.771952243	5.618	0.230245902	68.234	21.26554057	0.95	0.327
150	18.043	2.038598121	1.895	0.077663934	61.714	19.23354297	-0.64	0.220
180	15.149	1.711617964	2.256	0.092459016	74.813	23.31592589	0.063	0.021

[NH<sub>3</sub>] = 2M; [NH<sub>4</sub>CO<sub>3</sub>] = 0.2M; Agitation: 300rpm; Temperature: Ambient; PSD: -75µm

**Table 1(b) Preliminary Results for the effect of reducing agent on leaching with 0.01M reducing agent**

Time (mins)	[Co] (ppm)	Co Ext. (%)	[Fe] (ppm)	Fe Ext. (%)	[Cu] (ppm)	Cu Ext. (%)	[Mn] (ppm)
30	21.474	2.426252	1.606	0.065819672	134.902	42.04302774	0.375
60	14.07	1.589707	1.413	0.057909836	72.564	22.61501138	-0.061
90	15.725	1.776698	2.746	0.112540984	72.685	22.65272176	0.168
120	13.211	1.492652	1.479	0.060614754	74.695	23.27915047	-0.198
150	12.763	1.442034	1.975	0.080942623	72.397	22.56296481	0.153
180	15.035	1.698738	1.602	0.065655738	65.784	20.50198319	3.062

[NH<sub>3</sub>] = 2M; [NH<sub>4</sub>CO<sub>3</sub>] = 0.2M; Agitation: 300rpm; Temperature: Ambient; PSD: -75µm

**Table 1(c): Preliminary results for the effect of reducing agent on leaching with 0.02M Reducing Agent**

Time (mins)	[Co](ppm)	Co Ext. (%)	[Fe] (ppm)	Fe Ext. (%)	[Cu] (ppm)	Cu Ext. (%)	[Mn] (ppm)
30	19.209	2.170339	1.533	0.062827869	125.886	39.23313657	-0.076
60	12.586	1.422036	1.636	0.06704918	69.359	21.61615366	-0.054
90	13.102	1.480337	2.894	0.118606557	68.623	21.38677479	0.059
120	16.682	1.884825	3.631	0.148811475	73.811	23.0036465	0.101
150	15.697	1.773534	1.247	0.051106557	73.325	22.85218165	0.894
180	17.595	1.987981	13.253	0.543155738	78.405	24.43539451	-0.089

[NH<sub>3</sub>] = 2M; [NH<sub>4</sub>CO<sub>3</sub>] = 0.2M; Agitation: 300rpm; Temperature: Ambient; PSD: -75µm

**Table 1(d): Preliminary results on the effect of reducing agent on leaching at 0.04M reducing agent**

Time (mins)	[Co](ppm)	Co Ext. (%)	[Fe] (ppm)	Fe Ext. (%)	[Cu] (ppm)	Cu Ext. (%)	[Mn] (ppm)
30	17.437	1.970129	3.651	0.149631148	112.478	35.05445193	0.121
60	13.006	1.46949	2.469	0.101188525	63.155	19.68263937	0.215
90	19.716	2.227623	17.186	0.704344262	68.693	21.40859071	3.015
120	15.221	1.719753	8.085	0.331352459	80.005	24.93404422	-0.279
150	14.156	1.599423	5.233	0.214467213	75.238	23.44837972	7.159
180	14.263	1.611513	2.164	0.088688525	82.91	25.83940512	0.298

[NH<sub>3</sub>] = 2M; [NH<sub>4</sub>CO<sub>3</sub>] = 0.2M; Agitation: 300rpm; Temperature: Ambient; PSD: -75µm

**Table 1(e) Preliminary results on the effect of reducing agent on leaching**

Time (mins)	[Co](ppm)	Co Ext. (%)	[Fe] (ppm)	Fe Ext. (%)	[Cu] (ppm)	Cu Ext. (%)	[Mn] (ppm)	Mn Ext. (%)
30	14.15	1.598745	1.15	0.047131148	116.111	36.18669844	-0.006	-0.00207
60	14.16	1.599875	1.887	0.077336066	65.448	20.39726675	0.251	0.086552
90	16.439	1.857369	10.953	0.448893443	77.817	24.25214073	1.272	0.438621
120	14.018	1.583831	2.932	0.120163934	79.8	24.87015473	-0.488	-0.16828
150	31.503	3.559384	27.479	1.126188525	66.91	20.85290793	0.177	0.061034
180	15.26	1.724159	2.145	0.087909836	80.036	24.94370556	-0.44	-0.15172

[NH<sub>3</sub>] = 2M; [NH<sub>4</sub>CO<sub>3</sub>] = 0.2M; Agitation: 300rpm; Temperature: Ambient; PSD: -75µm

**Table 1(f): Preliminary results on the effect of reducing agent on leaching at 0.1M reducing agent**

Time (mins)	[Co] (ppm)	Co Ext. (%)	[Fe] (ppm)	Fe Ext. (%)	[Cu] (ppm)	Cu Ext. (%)	[Mn] (ppm)	Mn Ext. (%)
30	24.139	2.727	1.27	0.052	98.25	30.620	0.374	0.128
60	27.772	3.138	2.562	0.105	76.808	23.938	0.362	0.124
90	26.267	2.968	3.609	0.148	81.166	25.296	0.883	0.304
120	30.455	3.440	1.75	0.072	82.748	25.789	-0.579	0
150	27.912	3.153	2.783	0.114	64.827	20.204	-0.069	0
180	28.539	3.224	1.881	0.0771	79.989	24.929	0.878	0.302

[NH<sub>3</sub>] = 2M; [NH<sub>4</sub>CO<sub>3</sub>] = 0.2M; Agitation: 300rpm; Temperature: Ambient; PSD: -75µm

**Table 1(g): The Effect of Reducing Agent Concentration at 0.0M-1.0M (NH<sub>4</sub>)<sub>2</sub>SO<sub>3</sub>**

<b>Time (mins)</b>	<b>[(NH<sub>4</sub>)<sub>2</sub>SO<sub>3</sub> (M)]</b>	<b>[Co] (ppm)</b>	<b>Co Ext. (%)</b>	<b>[Fe] (ppm)</b>	<b>Fe Ext. (%)</b>	<b>[Mn] (ppm)</b>	<b>Mn Ext. (%)</b>	<b>[Cu] (ppm)</b>	<b>Cu Ext. (%)</b>
30	0	7.633	2.435289	0.161	0.016263	0.125	0.080645	30.074	75.69283
	0.2	45.612	14.55239	0.071	0.007172	0.102	0.065806	21.42	53.9117
	0.4	47.756	15.23643	0.032	0.003232	0.18	0.116129	24.606	61.9305
	0.6	60.041	19.15593	0.023	0.002323	0.957	0.617419	23.719	59.69802
	0.8	67.03	21.38575	-0.007	-0.00071	0.278	0.179355	25.049	63.04548
	1	66.681	21.2744	0.289	0.029192	0.177	0.114194	23.663	59.55707
60	0	8.466	2.701056	0.078	0.007879	0.017	0.010968	30.443	76.62156
	0.2	55.191	17.60855	-0.002	-0.0002	1.744	1.125161	31.825	80.0999
	0.4	64.203	20.4838	-0.009	-0.00091	0.206	0.132903	28.651	72.1113
	0.6	75.073	23.95185	-0.006	-0.00061	0.164	0.105806	30.026	75.57202
	0.8	82.402	26.29015	0.237	0.023939	OVER	#VALUE!	31.779	79.98412
	1	81.161	25.89421	-0.021	-0.00212	0.435	0.280645	30.202	76.01499
90	0	9.845	3.141022	0.041	0.004141	0.052	0.033548	36.678	92.31434
	0.2	63.068	20.12168	-0.03	-0.00303	0.212	0.136774	35.943	90.46443
	0.4	69.185	22.0733	-0.006	-0.00061	0.021	0.013548	30.156	75.89921
	0.6	83.017	26.48636	0.255	0.025758	OVER	#VALUE!	33.419	84.11181
	0.8	84.99	27.11584	-0.014	-0.00141	0.511	0.329677	33.219	83.60843
	1	86.789	27.68981	-0.016	-0.00162	0.163	0.105161	24.133	60.74001
120	0	11.542	3.682446	0.074	0.007475	0.04	0.025806	28.535	71.81934
	0.2	61.581	19.64726	-0.03	-0.00303	0.046	0.029677	25.368	63.84836
	0.4	80.171	25.57835	-0.019	-0.00192	-0.044	-0.02839	24.819	62.46659
	0.6	82.459	26.30833	-0.05	-0.00505	0.057	0.036774	32.054	80.67626
	0.8	79.844	25.47402	0.007	0.000707	0.136	0.087742	29.869	75.17687
	1	84.714	27.02779	0.359	0.036263	OVER	#VALUE!	31.098	78.27012
150	0	11.476	3.661389	-0.021	-0.00212	0.067	0.043226	31.342	78.88424
	0.2	62.202	19.84539	-0.024	-0.00242	0.111	0.071613	31.716	79.82555
	0.4	72.331	23.07702	-0.048	-0.00485	0.243	0.156774	33.823	85.12863
	0.6	83.778	26.72916	-0.045	-0.00455	0.089	0.057419	21.588	54.33453
	0.8	82.126	26.20209	-0.104	-0.01051	0.106	0.068387	31.041	78.12666
	1	69.338	22.12211	-0.043	-0.00434	0.156	0.100645	24.671	62.09409

180	0	13.458	4.293741	0.102	0.010303	-0.062	0	36.15	90.98543
	0.2	68.911	21.98588	0.113	0.011414	0.549	0.354194	22.766	57.29943
	0.4	72.768	23.21644	0.008	0.000808	0.06	0.03871	28.074	70.65906
	0.6	83.651	26.68864	-0.087	0	OVER	#VALUE!	30.572	76.94624
	0.8	89.999	28.71395	0.233	0.023535	OVER	#VALUE!	24.393	61.3944
	1	87.662	27.96834	-0.07	0	0.401	0.25871	25.224	63.48593

***[NH<sub>3</sub>]: 4.0M; [(NH<sub>4</sub>)<sub>2</sub>CO<sub>3</sub>]: 0.4M; 60°C; 300rpm; -75μm***

***Table 1 (h): The Effect of Reducing Agent Concentration At 60°C***

[(NH <sub>4</sub> ) <sub>2</sub> SO <sub>3</sub> ] (M)	[Cu] (ppm)	Cu Ext. (%)	[Co] (ppm)	Co Ext. (%)	[Fe] (ppm)	Fe Ext. (%)	[Mn] (ppm)	Mn Ext. (%)
0	281.269	88.49025	1.005	3.206427	0.558	0.056364	0.0259	0.01671
0.02	272.069	85.59583	1.256	4.007236	1.538	0.155354	0.276	0.178065
0.04	262.362	82.5419	4.993	15.93004	2.172	0.219394	1.057	0.681935
0.08	262.399	82.55354	11.963	38.16765	0.643	0.064949	0.465	0.3
0.1	261.678	82.32671	12.236	39.03865	1.066	0.107677	0.597	0.385161

***[NH<sub>3</sub>] = 2M; [NH<sub>4</sub>CO<sub>3</sub>] = 0.2M; Agitation: 300rpm; 60°C; PSD: -75μm***

## Appendix 2: The effect of temperature on leaching

Tables 2(a)-2(d) show the extraction efficiency at different temperatures efficiency. Table 2(e) shows extraction temperature at 80°C using the optimised leaching procedure.

**Table 2(a): Extraction at Ambient Temperature**

Time/mins	[Co] (ppm)	Co Ext. (%)	[Fe] (ppm)	Fe Ext. (%)	[Cu] (ppm)	Cu Ext. (%)	[Mn] (ppm)	Mn Rec/%
30	22.039	7.03	0.851	0.0859	278.284	65.663	2.337	1.507
60	21.81	6.958	-0.072	0	239.14	56.427	2.367	1.527
90	20.151	6.429	-0.249	0	130.633	30.823	2.875	1.854
120	24.996	7.974	-0.034	0	325.546	76.815	2.841	1.832
150	21.375	6.819	0.131	0.0132	339.668	80.147	2.739	1.767
180	15.602	4.977	-0.099	0	352.557	83.188	2.302	1.485

$[NH_3]= 4.0M$ ;  $[(NH_4)_2CO_3]= 0.4M$ ;  $[(NH_4)_2SO_3]= 0.4M$ ; Agitation= 300RPM

**Table 2(b) Extraction at 40°C**

Time (mins)	[Co] (ppm)	Co Ext. (%)	[Fe] (ppm)	Fe Ext. (%)	[Cu] (ppm)	Cu Ext. (%)	[Mn] (ppm)	Mn Ext. (%)
30	21.598	6.890	-0.123	0	214.551	50.625	4.955	3.196
60	32.195	10.271	-0.115	0	275.156	64.925	9.368	6.0438
90	35.967	11.475	-0.231	0	257.239	60.697	2.14	1.380
120	30.606	9.764	-0.403	0	286.674	67.643	2.1	1.354
150	33.483	10.682	-0.195	0	410.2	96.789	2.012	1.298
180	33.634	10.730	-0.536	0	264.17	62.333	1.957	1.262

$[NH_3]= 4.0M$ ;  $[(NH_4)_2CO_3]= 0.4M$ ;  $[(NH_4)_2SO_3]= 0.4M$ ; Agitation= 300RPM

**Table 2 (c) Extraction at 60°C**

Time (mins)	[Co] (ppm)	Co Ext. (%)	[Fe] (ppm)	Fe Ext. (%)	[Cu] (ppm)	Cu Ext. (%)	[Mn] (ppm)	Mn Ext. (%)
30	79.744	25.44212	0.269	0.027171717	120.835	28.51199186	3.898	2.514839
60	128.003	40.839031	0.18	0.018181818	332.266	78.40083988	8.562	5.523871
90	125.938	40.180198	-0.022	0	253.258	59.75826569	5.351	3.452258
120	122.758	39.165627	-0.638	0	260.443	61.45362433	3.653	2.356774
150	121.734	38.838923	-0.171	0	167.29	39.47342341	2.961	1.910323
180	127.814	40.778731	-0.028	0	303.196	71.54153916	2.702	1.743226

*[NH<sub>3</sub>]: 4.0M; [(NH<sub>4</sub>)<sub>2</sub>CO<sub>3</sub>]: 0.4M; [(NH<sub>4</sub>)<sub>2</sub>SO<sub>3</sub>]: 0.4M; 300rpm*

**Table 2(d) Extraction at 80°C**

Time/mins	Co/ppm	Co Rec./%	Fe/ppm	Fe Rec/%	Cu/ppm	Cu Rec %	Mn/ppm	Mn Rec/%
30	34.922	11.141775	-0.059	0	107.193	25.29305204	3.402	3.402
60	52.017	16.595891	-0.215	0	168.543	39.76907886	2.488	2.488
90	57.462	18.333105	-0.563	0	131.717	31.07968744	1.774	1.774
120	54.656	17.437858	0.131	0.013232323	156.094	36.831637	1.431	1.431
150	56.966	18.174857	-0.135	0	302.898	71.47122366	1.175	1.175
180	56.079	17.891862	0.221	0.022323232	145.209	34.26323355	0.745	0.745

*[NH<sub>3</sub>]= 4.0M; [(NH<sub>4</sub>)<sub>2</sub>CO<sub>3</sub>]= 0.4M; [(NH<sub>4</sub>)<sub>2</sub>SO<sub>3</sub>]= 0.4M; Agitation= 300RPM*

**Table 2(e): The Effect of Leaching at 80°C**

[Cu]	Cu Ext.	[Co]	Co Ext	[Fe]	Fe Ext.	[Mn]	Mn Ext.
135.69	84.57723	12.993	73.40106	0.8957	1.835451	0.6756	10.89677

*[NH<sub>3</sub>]= 4.0M; [(NH<sub>4</sub>)<sub>2</sub>CO<sub>3</sub>]= 0.4M; [(NH<sub>4</sub>)<sub>2</sub>SO<sub>3</sub>]= 0.4M; 300rpm;*

**Appendix 3: The effect of particle size distribution on leaching**

Table 3 shows results of leaching extraction when the particle size distribution is varied at 60°C, 4.0M ammonia solution, 0.4M ammonium carbonate solution and 0.4M reducing agent concentration.

**Table 3: The Effect of Particle Size Distribution on Leaching**

<i>Time</i>	<i>PSD</i>	<i>[Co]</i> <i>ppm</i>	<i>Co Ext.</i> <i>(%)</i>	<i>Cu</i> <i>(ppm)</i>	<i>Cu Ext.</i> <i>(%)</i>	<i>[Fe]</i> <i>(ppm)</i>	<i>Fe Ext.</i> <i>(%)</i>	<i>[Mn]</i> <i>(ppm)</i>	<i>Mn Ext.</i> <i>(%)</i>
30	150	60.259	19.22548	152.089	47.84883	6.016	0.607677	2.397	1.546452
	75	164.64	37.20388	208.01	51.86206	13.936	1.142295	2.854	1.359048
	53	96.147	39.05057	166.937	65.82156	13.621	1.641084	2.846	2.371667
	38	97.348	44.58592	169.268	66.74065	12.94	1.760544	2.329	2.025217
60	150	69.269	22.1001	251.666	79.17683	19.39	1.958586	2.389	1.54129
	75	156.483	35.36063	328.076	81.7975	9.014	0.738852	3.996	1.902857
	53	90.315	36.68188	208.145	82.06945	5.949	0.716747	2.413	2.010833
	38	98.71	45.20972	173.249	82.23469	19.546	2.65932	2.881	2.505217
90	150	60.277	19.23122	255.069	80.24745	14.772	1.492121	2.893	1.866452
	75	150.281	33.95916	331.31	82.60382	12.803	1.049426	1.349	0.642381
	53	83.656	33.97729	211.993	83.58668	16.795	2.023494	1.665	1.3875
	38	82.528	37.79828	176.256	83.662	11.845	1.611565	2.022	1.758261
120	150	48.248	15.3934	273.265	85.9721	12.216	1.233939	1.718	1.108387
	75	127.736	28.86464	363.961	90.74453	16.308	1.336721	0.391	0.18619
	53	75.94	30.8434	230.654	90.94452	11.574	1.394458	1.071	0.8925
	38	82.289	37.68881	191.756	91.01926	11.027	1.500272	0.559	0.486087
150	150	51.099	16.30301	251.005	78.96887	7.58	0.765657	0.398	0.256774
	75	133.406	30.1459	326.437	81.38886	10.908	0.894098	1.109	0.528095
	53	73.21	29.7346	265.056	83.38947	9.061	1.091687	0.66	0.55
	38	80.258	36.7586	179.749	85.31999	14.501	1.972925	0.496	0.431304
180	150	49.631	15.83464	183.746	57.80847	6.929	0.699899	0.681	0.439355
	75	120.36	27.19788	322.008	80.2846	10.905	0.893852	1.087	0.517619
	53	75.59	30.70125	320.908	80.01034	14.711	1.77241	0.743	0.619167
	38	78.257	35.84213	332.39	82.87309	13.367	1.818639	Spilled	#VALUE!

*[NH<sub>3</sub>]: 4M; [(NH<sub>4</sub>)<sub>2</sub>CO<sub>3</sub>]: 0.4M; [(NH<sub>4</sub>)<sub>2</sub>SO<sub>3</sub>]: 0.4M; Agitation: 300rpm; Temp: 60°C*



**Appendix 4: The Effect of the concentrations of Ammonia Solution and Ammonium Carbonate**

**Table 4: The effect of the concentrations of ammonia and ammonium carbonate**

$[NH_3]$ (M)	$[(NH_4)_2CO_3]$ (M)	pH	mV	[Cu] (ppm)	Cu Ext. %	[Co] (ppm)	Co Ext. %	[Fe] (ppm)	Fe Ext. %	[Mn] ppm	Mn Ext. %
0.5	0.1	10.61	-126	112.835	70.33143	9.569	54.05793	0.229	0.469262	0.128	1.52381
1		10.93	-156	103.887	64.75403	9.698	54.78669	0.123	0.252049	0.245	2.916667
2		11.33	-138	54.692	34.09019	4.218	23.82865	0.031	0.063525	0.076	0.904762
4		11.77	-133	40.098	24.99357	2.253	12.72782	0.059	0.120902	0.121	1.440476
0.5	0.2	9.89	-125	114.241	71.2078	11.256	63.58826	0.072	0.147541	0.163	1.940476
1		9.95	-102	122.369	76.27408	13.488	76.19745	0.115	0.235656	0.041	0.488095
2		10.32	-99	123.426	76.93293	13.421	75.81895	0.039	0.079918	0.035	0.416667
4		11.06	-101	108.946	67.90737	9.227	52.12588	0.011	0.022541	0.028	0.333333
0.5	0.4	9.49	-106	119.236	74.32125	10.009	56.54361	0.249	0.510246	0.054	0.642857
1		9.77	-143	136.29	84.95121	13.058	73.76826	0.231	0.473361	0.215	2.559524
2		10.08	-128	144.256	89.91652	13.227	74.72299	0.022	0.045082	0.0621	0.739286
4		10.42	-113	141.986	88.5016	13.699	77.38945	0.0659	0.135041	0.0874	1.040476
0.5	1	9.11	-199	64.982	40.50407	6.996	39.52234	0.088	0.180328	0.368	4.380952
1		9.35	-144	128.265	79.94913	12.691	71.69498	0.096	0.196721	0.193	2.297619
2		9.44	-109	129.389	80.64974	14.947	84.43974	0.115	0.235656	0.059	0.702381
4		9.77	-103	130.577	81.39023	13.525	76.40647	0.045	0.092213	0.022	0.261905

0.5	2	8.89	-223	55.266	34.44797	4.995	28.21814	0.994	2.036885	1.272	15.14286
1		9.05	-205	63.596	39.64016	7.029	39.70877	0.682	1.397541	0.883	10.5119
2		9.29	-119	125.887	78.4669	15.119	85.41142	0.321	0.657787	0.096	1.142857
4		9.55	-106	125.748	78.38026	15.262	86.21927	0.135	0.276639	0.085	1.011905
0.5	4	8.9	-239	39.254	24.4675	1.987	11.22511	1.056	2.163934	1.896	22.57143
1		9.15	-201	41.846	26.08312	3.961	22.37679	0.951	1.94877	0.846	10.07143
2		9.17	-186	65.008	40.52028	6.892	38.93482	0.773	1.584016	0.488	5.809524
4		9.51	-112	112.756	70.28218	13.558	76.5929	0.659	1.35041	0.108	1.285714

*[(NH<sub>4</sub>)<sub>2</sub>SO<sub>3</sub>]: 0.4M; 80°C; -75µm; 300rpm; 60 minutes Pre-Treatment; 60 minutes Leaching.*