

**‘The design and validation of an instrument to measure
the Topic Specific Pedagogical Content Knowledge of
physical sciences teachers in electric circuits.’**

Gwyneth Jean Zimmerman

A research report submitted to the Wits School of Education, Faculty of Humanities,
University of the Witwatersrand in fulfilment of the requirements for the degree of
Master of Education by combination of coursework and research

Johannesburg

2015

COPYRIGHT NOTICE

The copyright of this thesis vests in the University of the Witwatersrand, Johannesburg, South Africa, in accordance with the University's Intellectual Property Policy.

No portion of the text may be reproduced, stored in a retrieval system, or transmitted in any form or by any means, including analogue and digital media, without prior written permission from the University. Extracts of or quotations from this thesis may, however, be made in terms of Sections 12 and 13 of the South African Copyright Act No. 98 of 1978 (as amended), for non-commercial or educational purposes. Full acknowledgement must be made to the author and the University.

An electronic version of this thesis may be found via the Library's online catalogue. For permission requests, please contact the University Legal Office or the University Research Office (www.wits.ac.za).

ABSTRACT

Extensive research describes common misconceptions when learning to understand how electric circuits function and the concurrent difficulties of teaching this content. The primary purpose of this study was to design and validate an assessment tool that uses these misconceptions to measure teachers' Topic Specific Pedagogical Content Knowledge (TSPCK) for teaching electric circuits. In conjunction with the TSPCK assessment tool, a Content Knowledge (CK) assessment tool was adapted from existing content tests for electric circuits. The purpose of the CK assessment tool was to test the assumption that teachers' TSPCK cannot develop without them having prior CK.

The study used a Mixed-Method approach with both quantitative and qualitative analysis to determine validity and reliability. The TSPCK assessment tool items were designed using the following components: (i) Learners' Prior Knowledge; (ii) Curricular Saliency; (iii) What makes the topic difficult to understand; (iv) Representations and Analogies; (v) Conceptual Teaching Strategies (Mavhunga, 2012). The purpose of the TSPCK assessment tool was to extract teacher reasoning within these components. The responses were scored using a criteria referenced rubric. The scores were statistically analysed using Rasch analysis.

The CK and TSPCK assessment tools were found to be statistically valid. The small sample size of 16 respondents meant there were some concerns with regard to reliability. However, when the qualitative data is analysed together with quantitative data, an argument can be made that a valid and reliable assessment tool to measure TSPCK in electric circuits has been designed. The CK and TSPCK assessment tools for electric circuits are now available for further use in pre-service and in-service teacher training.

Keywords

Topics Specific Pedagogical Content Knowledge

Electric circuits

DECLARATION

I declare that this research report is my own unaided work. It is being submitted for the degree of Master of Education at the University of the Witwatersrand, Johannesburg. It has not been submitted before for any degree or examination at any other University.

Gwyneth Jean Zimmerman

22nd day of June in the year 2015

To Conrad, thank you for making this journey possible

PRESENTATIONS EMANATING FROM THIS RESEARCH

Rollnick, M., Mavhunga, E., Malcolm, S., Zimmerman, G., Bam, N., & van der Merwe, D. (2015). PCK Instruments: Are we measuring PCK? *23rd Annual Conference of the Southern African Association for Research in Mathematics, Science and Technology Education*. Maputo, Mozambique.

ACKNOWLEDGEMENTS

I wish to thank the following:

My supervisors Dr Carola Steinberg for her endless patience and encouragement and Prof Marissa Rollnick for her guidance and insight.

The staff of Curro Aurora and St Peter's College who was an integral part of this process.

The National Research Foundation for their funding

My two communities of faith, Kavod and Urban Springs who have supported and encouraged me to persevere.

My husband Conrad, my life's partner and love. My children Robyn and Gregory, my joy. Thank you for giving me the space and time to pursue this study

TABLE OF CONTENTS

COPYRIGHT NOTICE	i
ABSTRACT	iii
DECLARATION	iv
PRESENTATIONS EMANATING FROM THIS RESEARCH	vi
ACKNOWLEDGEMENTS	vii
TABLE OF CONTENTS	viii
LIST OF FIGURES	xii
LIST OF TABLES	xiv
LIST OF ABBREVIATIONS	xv
LIST OF APPENDICES	xvi
Chapter 1 – Introduction	1
1.1. Introduction	1
1.2. Problem	2
1.3. Aim	2
1.3.1. Research Questions	2
1.4. Rationale	3
1.4.1. Chapter overview	4
1.5. Conclusion	5
Chapter 2 – Literature Review	6
2.1. Introduction	6
2.2. The Nature of PCK	7
2.3. Models of PCK	10
2.4. Capturing and measuring PCK	20
2.4.1. Capturing PCK	20
2.4.2. Measuring PCK	21
2.5. Conceptual Framework	24
2.5.1. Foundational models of the TSPCK model	24
2.5.2. The connection between Content Knowledge (CK) and Pedagogical Content Knowledge (PCK)	25
2.5.3. Topic Specific PCK	26
2.6. Electric Circuits conceptual concerns	29
2.6.1. Common misconceptions with electric circuits	29
2.6.2. Potential conceptual strategies with electric circuits	33
2.7. Conclusion	35

Chapter 3 – Methodology	36
3.1. Introduction.....	36
3.2. Research Methodology.....	38
3.3. Participants.....	40
3.4. Assessment Tools.....	43
3.4.1. Determining the content coverage.....	43
3.4.3. A brief description of the final TSPCK assessment tool.....	48
3.4.4. Rubric used to analyse responses.....	50
3.5. Analysis and validation of assessment tools.....	51
3.5.1. Validity during the construction of the Content and TSPCK Tools.....	51
3.5.2. Quantitative validation.....	52
3.5.3. Qualitative analysis.....	54
3.6. Ethical issues.....	55
3.7. Conclusion.....	56

Chapter 4 - The process of developing and the validation of the Content Knowledge (CK) assessment tool	57
4.1. Introduction.....	57
4.2. Developing the CK assessment tool.....	59
4.2.1. Step 1: Selecting the content to be covered in the CK assessment tool.....	59
4.2.2. Step 2: Selection of items for CK assessment tool.....	60
4.2.3. Step 3: Evaluation and piloting of items for the content tool.....	64
4.2.4. Step 4: Selection of items for final CK assessment tool.....	65
4.2.5. Step 5: Distribution of CK assessment tool.....	68
4.3. Scoring and validation of the CK assessment tool.....	68
4.3.3. Step 6: Scoring the CK assessment tool.....	68
4.4. Validity and Reliability of the CK assessment Tool.....	76
4.4.1. Step 7: The interpretative argument for validity and reliability of CK assessment tool. 76	
4.4.2. Step 7 Continued: The statistical analysis of the CK assessment tool for validity and reliability.....	77
4.5. Conclusion.....	82

Chapter 5 – Development of the TSPCK assessment tool	83
5.1. Introduction.....	83
5.2. Development of TSPCK assessment tool.....	84
5.2.1. Summary of the steps taken in the development of the TSPCK assessment tool.....	84
5.2.2. Step 1: Conceptualisation of items for the TSPCK assessment tool.....	86

5.2.3.	Step 1 Continued: Defining the content to be covered in the TSPCK assessment tool ...	87
5.2.4.	Step 2 and 3: The development of items for the pre-pilot and pilot TSPCK tool.....	88
5.2.5.	An overview of the structure of the pilot TSPCK assessment tool	89
5.3.	The development of the final TSPCK assessment tool	96
5.3.1.	Step 4: Adaption and selection of items for final TSPCK assessment tool from the pilot TSPCK tool.....	97
5.3.2.	Step 5: Distribution of the TSPCK assessment tool	105
5.4.	Development of the assessment rubric for analysing and measuring the responses to the TSPCK tool	106
5.4.1.	Step 6: Development of the assesment rubric.....	106
5.4.2.	Step 7: Categorising the responses using the rubric.....	111
5.2.	Conclusion	113

Chapter 6 -Validity and Reliability of TSPCK Assessment Tool 114

6.1.	Introduction.....	114
6.2.	Defining construct validity and reliability in relation to the TSPCK assessment tool	114
6.3.	Overview of the interpretative and statistical arguments used to determine validity and reliability	115
6.3.1.	Interpretative argument for construct validity and reliability.....	116
6.3.2.	Statistical argument for construct validity and reliability	116
6.4.	Analysing the final TSPCK assessment tool for statistical construct validity and reliability.....	117
6.4.1.	Raw scores for TSPCK assessment tool and summary Rasch analysis.....	118
6.5.	Validity and reliability statistics of the Rasch analysis	119
6.5.1.	Interpreting validity of TSPCK assessment with Rasch analysis	119
6.5.2.	Reliability of the TSPCK assessment tool.....	122
6.5.3.	Conclusion of statistical argument for validity and reliability.....	127
6.6.	Interpretative argument for validity and reliability	127
6.6.1.	Category A - Prior knowledge and misconceptions	128
6.6.2.	Category B – Curricular Saliency	131
6.6.3.	Category E – Conceptual teaching strategies.....	136
6.6.4.	Conclusion of interpretative argument.....	138
6.7.	Relationship between TSPCK and CK assessment tools.....	138
6.8.	Conclusion	141

Chapter 7 - Discussion of findings, implication of results and conclusion 143

7.1.	Introduction.....	143
7.1.1.	Methodology Overview	144

7.2.	Findings and discussion	147
7.2.1.	Research question 1	147
7.2.2.	Research question 2	154
7.2.3.	Research question 3	158
7.2.4.	Overall Research Aim.....	160
7.3.	Reflections on the study.....	160
7.3.1.	Concept of PCK and TSPCK.....	161
7.3.2.	Electric circuits and TSPCK.....	162
7.4.	Limitations of the study	163
7.5.	Recommendations moving forward.....	164
7.5.1.	Methodology.....	164
7.5.2.	Item revision	164
7.5.3.	Large scale testing.....	165
7.5.4.	The use of the TSPCK assessment tool in the training of pre-service teachers.....	165
7.5.5.	The use of the TSPCK assessment tool in the training of in-service teachers	166
7.5.6.	Directions for future research	166
7.6.	Conclusions and implications	167
REFERENCE LIST		169

LIST OF FIGURES

Figure 1: Flow diagram from Mornine-Dershimer and Kent describing the facets of PCK	9
Figure 2: A representation of the difference between the transformative and integrative models of PCK	12
Figure 3: A flow diagram of the development of models of PCK	14
Figure 4: Representations of the Grossman and Magnusson <i>et. al</i> Models of PCK	15
Figure 5: Consensus model for teacher professional knowledge and skill including PCK and influences of classroom practice and student outcomes	19
Figure 6: Schematic representation of the Tailored PCK model (Rollnick et al, 2008) and the Modified PCK model (Davidowitz & Rollnick, 2011)	25
Figure 7: Schematic diagram of the Topic Specific Model of Mavhunga (2012)	27
Figure 8: Flow diagram showing steps involved in the design and validation of the CK and TSPCK Tools. The blue blocks relate to the Content Tool, the yellow to the TSPCK Tool and the white to processes common to both.	37
Figure 9: A flow diagram outlining the process of development and analysis of items for the content and CK tool	58
Figure 10: Extract showing the original item in the Three-Tier Test (Pesman et al) tool and the changes made for the CK assessment tool.	64
Figure 11: Diagram showing Question 19 from the CK assessment tool	73
Figure 12: Item-Person Map of the CK assessment tool generated by Rasch analysis.	80
Figure 13: A flow diagram of the steps involved in the design and validation of the TSPCK assessment tool	85
Figure 14: An example of a pilot item for Category A	89
Figure 15: An example of a pilot item in Category B	90
Figure 16: An example of a pilot item in Category C	91
Figure 17: An example of a representations Category D in the pilot TSPCK assessment tool	92
Figure 18: An example of a pilot item from Category E	95
Figure 19: An Extract from the TSPCK pilot tool showing an example of a teacher response. The portion used in the final TSPCK tool is highlighted	98
Figure 20: Extracts from the pilot TSPCK assessment tool showing the changes made in the final TSPCK assessment tool.	99
Figure 21: Item relating to terminology in Category C	102

Figure 22: Items retained for Category D in the final TSPCK tool.	103
Figure 23: An extract from the Mavhunga and Rollnick TSPCK rubric	106
Figure 24: Extract from first generic rubric	107
Figure 25: Extracts from the rubric used in the first validation process and the adaptations made for the second. The particular points of addition and alteration are highlighted in blue and yellow. The addition of verbatim examples are highlighted in pink	109
Figure 26: Adjustments made after second validation	110
Figure 27: Extract from respondent 104, 107 and 110 to illustrate level and variety of answers coded by the assessment rubric	111
Figure 28: Rasch bubble plot for persons and items.	121
Figure 29: Person-Item map for the TSPCK assessment tool	126
Figure 30: Item selected as an example for the qualitative analysis of a Category A	129
Figure 31: Item A2 and example of the type of responses, extracted from respondents 102 and 107	130
Figure 32: The Category B list of “Big Ideas” and other sub-ordinate ideas for item B1 and 2	132
Figure 33: Concept map analysis for respondents 102, 107 and 111	133
Figure 34: Example of responses for Category E from respondents 101 and 105	.137
Figure 35: Bubble plot showing relative position in relation to CK and TSPCK	140

LIST OF TABLES

Table 1: Summary of misconceptions held with regards to electric circuits.....	30-31
Table 2: A summary of the demographic information of the participants of the study.....	42
Table 3: Summary of electric circuit content used in the CK and TSPCK assessment tools, drawn from Loughran’s CoRe and the CAPS (Curriculum and Assessment Policy Statement) for grade 10 physical science.....	44-45
Table 4: A summary of the content selected for the CK assessment tool.....	59
Table 5: Table showing the comparison of the 3 selected tests against misconceptions with electric circuits.....	62
Table 6: Showing the content summary covered by the pilot CK assessment tool and the items retained for the final tool, together with reasons for exclusion, and the related misconception of each of the retained questions.....	66
Table 7: Table showing scoring results of CK assessment tool and confidence rating.....	70-71
Table 8: A summary of the most problematic topics in the CK assessment tool.....	72
Table 9: Summary of the number of misconceptions identified in the CK assessment tool.....	74
Table 10: Table showing the person measure statistics generated by Rasch analysis.....	78
Table 11: Table showing the item measure statistics generated by Rasch analysis.....	79
Table 12: Summary of the Rasch statistical analysis of the CK assessment tool.....	81
Table 13: Raw data from TSPCK tools per question, CK assessment tool and confidence level percentage.....	118
Table 14: Summary of Person measure data.....	120
Table 15: Summary of the Rasch reliability analysis for Persons	123
Table 16: Summary of Rasch reliability analysis for Items	123
Table 17: Item measure by Category ranked from most difficult to easiest.....	124
Table 18: Item measure by individual items ranked from most difficult to easiest.....	125

LIST OF ABBREVIATIONS

PCK – Pedagogical Content Knowledge

TSPCK – Topic Specific Pedagogical Content Knowledge

MM – Mixed Methods

CAPS – Curriculum and Assessment Policy Statement

CK – Content Knowledge

SMK – Subject Matter Knowledge

emf – Electro motor force

pd – Potential difference

ZSTD – Standardised z-score

MNSQ – Mean square

LIST OF APPENDICES

APPENDIX A: Final TSPCK assessment tool

APPENDIX B: Rubric for Final TSPCK assessment tool

APPENDIX C: Final Content Knowledge assessment tool

APPENDIX D: Memorandum for Final Content Knowledge assessment tool

APPENDIX E: Participant information and consent letter

APPENDIX F: Information and memorandum given to teachers after completion of assessment
tools

APPENDIX G: Ethics permission letter

APPENDIX H: An example of a completed TSPCK assessment tool

Chapter 1 – Introduction

This chapter discusses the purpose of this project is to design and validate an assessment instrument that evaluates teachers' Topic Specific Pedagogical Content Knowledge (TSPCK) in electric circuits. The design of the assessment instrument draws on Shulman's initial concept of PCK, subsequent refinements made by other researchers, literature regarding misconceptions in electric circuits, and assessment literature.

1.1. Introduction

The classroom is a dynamic and complex environment with a multitude of overlapping influences. The primary purpose of the teacher is to create an environment that is conducive for learning to occur. To achieve this, the knowledge a teacher brings into a classroom needs to encompass more than pure discipline content knowledge. Shulman described this specialised teacher knowledge or Pedagogical Content Knowledge (PCK) as:

“That special amalgam of content and pedagogy that is uniquely the providence of teachers...PCK...represents the blending of content and pedagogy into an understanding of how particular topics, problems, or issues are organized, represented, and adapted to diverse interests and abilities of learners, and presented for instruction.” (Shulman, 1987, p. 8)

Determining the nature of PCK is difficult because it is a personal and internal construct of the teacher. Although the nature (and sometimes even the existence) of PCK is still under debate, this research project takes the position that PCK is observable and measurable. The proposed project involves designing an assessment tool that intends to make explicit the PCK of teachers with regard to electric circuits. Mavhunga and Rollnick's (2013) model for assessing PCK at a topic level, which they termed Topic Specific Pedagogical Knowledge (TSPCK), will provide the framework for the design of the assessment tool.

1.2. Problem

I have observed, in my own teaching practice, the difficulty that students experience in grasping the abstract material of electric circuits. The literature confirms this anecdotal observation (Mulhall, McKittrick, & Gunstone, 2001, Hart, C, 2008, Tarciso Borges & Gilbert, 2010). Teachers' special skill lies in how they bridge this conceptual gap – it is what Shulman terms their '*wisdom of practice*' (Shulman, 1987). The concept of PCK provides a framework for investigating the strategies that teachers employ to make knowledge accessible. However, the exact nature, and what is measurable as PCK is problematic. Several models of PCK have been proposed since Shulman's initial proposal of the term to address this elusive nature of PCK, which will be presented in detail in the literature review. Building on these models, Mavhunga and Rollnick designed an assessment tool to measure teachers' Topic Specific PCK (TSPCK) in chemical equilibrium. This study aims to determine if a similar tool can be designed for electric circuits, i.e. a tool which allows for an evaluation of higher and lower quality PCK with specific reference to electric circuits. The tool will also be validated, as with any assessment instrument there needs to be a reasonable level of certainty that the test measures what it intends to test and is reliable to the extent in which similar results will be achieved in different settings (Scaife, 2004, pp. 65,68).

1.3. Aim

The aim of this master's research project is to design and validate an assessment tool that evaluates teachers' Topic Specific Pedagogical Content Knowledge of electric circuits.

1.3.1. Research Questions

The critical question I would like to investigate is: 'What are the most appropriate means for designing and validating an assessment tool to measure a teachers' TSPCK in electric circuits?' In order to answer this critical question, the following sub-questions will need to be answered.

1. What are the most appropriate methods for designing assessment tools for measuring teachers' Content Knowledge (CK) and Topic Specific Pedagogical Content Knowledge (TSPCK) in electric circuits?
2. How valid and reliable are the two assessment tools that were designed?
3. What is the relationship between teachers' CK and TSPCK?

1.4. Rationale

The poor performance of South African students in Trends in International Mathematics and Science Studies (TIMSS) highlighted a significant problem with science and mathematics teaching (Dempster & Reddy, 2007). In his study of matric physical science teachers' problem solving abilities Selvaratnam, (2011) showed that the majority of teachers were not able to perform problem-solving skills, within the curriculum criteria, competently. Chisholm, (2009) also noted that many South African science teachers are under-qualified or have science degrees in disciplines other than physical science. The need for well-qualified and capable physical science teachers is evident. The PCK research group at the University of Witwatersrand has been investigating whether using the results and the assessment tools can contribute to improved teaching for pre-service and in-service teachers, which in turn may lead to more highly skilled teachers. In order to substantiate a claim of 'improvement' there needs to be describable or measurable criteria. This requirement of measurement has led to the focus of the PCK research on designing assessment tools to measure teachers' PCK within specific topics. The design of a series of instruments is building a data source of relevant assessment tools and a baseline understanding of practice that could possibly be used in the training of pre-service teachers. This master's research project makes a small contribution to this larger project.

To date, only chemistry topics have been dealt with in the University of Witwatersrand TSPCK project, and there is need to develop assessment tools in physics topics as well. Electric circuits have been selected from the topics within physics because I see it as potentially being a rich source of teacher PCK. The abstract nature of the topic of electric circuits means that teachers use various strategies to make it accessible to their

students. Students also come into the classroom with misconceptions about the topic which the teacher has to understand and mediate. The manner in which teachers transform electric circuit knowledge for learners and their reasoning behind this transformation forms part of their TSPCK.

1.4.1. Chapter overview

Chapter 1 - Introduction

Introduces the problem and research question

Chapter 2 - Literature Review

The review of literature describes:

- (i) the development of the construct of TSPCK
- (ii) the methods and approaches taken to measure PCK and TSPCK
- (iii) the misconceptions that exist when teaching electric circuits

Chapter 3 - Methodology

The chosen methods used for this project are described. Both qualitative and quantitative methods were selected, which means that this research adopts a Mixed-Method methodology. The demographics of the sample population, the electric circuit content selected and ethical consideration are also included in this chapter.

Chapter 4 - The design and validation of the CK assessment tool

The steps of the design process of the CK assessment tool are described. The raw data from the CK assessment tool are presented, together with both quantitative and qualitative analyses of validity and reliability of this tool.

Chapter 5 - The design of the TSPCK assessment tool

The steps and considerations taken in order to design the final TSPCK assessment are described in this chapter.

Chapter 6 - Determining the validity and reliability of the TSPCK assessment tool

The data from the TSPCK assessment tool is presented, together with quantitative and qualitative arguments for validity. The final section of this chapter describes the relationship between the CK and TSPCK scores, both quantitatively and qualitatively.

Chapter 7 - Discussion

This final chapter presents a discussion of the results and arguments in response to the research questions. Limitations, recommendations and conclusions will also be presented.

1.5. Conclusion

The focus of this project is to design two assessment tools on the topic of electric circuits, one for CK and the other for TSPCK. After the design process the validity and reliability of the two tools will need to be determined. In the next chapter the relevant literature and a theoretical framework, for this project will be described. The major sites of misconception within the topic of electric circuits will also be presented.

Chapter 2 – Literature Review

In this chapter a review of the literature relating to this study will be presented. There are three sections. Firstly, the literature relating to the construct of Pedagogical Content Knowledge (PCK) will be presented. The next component is a review of the literature relating the methods and problems with measuring PCK. The theoretical framework of Topic Specific PCK flows out of these problems and forms the conceptual basis of this study. The final section reviews the literature that describes common misconceptions and problems with teaching electric circuits.

2.1. Introduction

The idea that a teacher holds a unique knowledge base which moves beyond content knowledge and knowledge of pedagogical strategies, has caught the attention of educational researchers. This unique blend of knowledge domains was first described by Shulman (1987). He termed it Pedagogical Content Knowledge (PCK) and it was one of 7 knowledge types he identified that teachers possess. Since Shulman's initial conception researchers have used this construct, particularly in mathematics and sciences, to describe more carefully what the unique knowledge base of teachers is. Ultimately what teachers know will impact the knowledge transferred to learners. Having good content knowledge does not automatically mean the teacher has the ability to transform it in a meaningful way for students (Kind, 2009). It is this need, particularly in the sciences, to have high quality teachers who do more than re-package content that has led to research which describes and measures what Shulman termed the '*missing paradigm*'.

Initially, researchers proposed various models to describe what constitutes PCK. These models then were the basis to begin to measure what constitutes 'good' or 'bad' PCK. Developing from these studies the idea developed that PCK is topic specific (van Driel, Verloop, & de Vos, 1998, Loughran, Berry, & Mulhall, 2004). In this project the focus will

be on how teachers transform the topic specific knowledge for the teaching of electric circuits.

2.2. The Nature of PCK

A key characteristic of PCK is its elusiveness. Shulman, in his 1986 essay, was commenting on the need to restore balance between content knowledge and pedagogical knowledge and was concerned to emphasise the inter-relation between the two concepts. He suggested that content teachers' knowledge comprised of 3 categories:

- (i) Content knowledge – this refers to the amount and organisation of the teachers knowledge
- (ii) Pedagogical Content Knowledge - which goes beyond knowing the subject matter and includes knowledge for teaching?
- (iii) Curricular Knowledge – which is an understanding of the curriculum and knowledge the materials available to support the curricular goal (Shulman, 1986)

Most people can recount stories of having a teacher who was brilliant within their discipline but did not have the ability to teach. Shulman proposed this category of special knowledge which '*goes beyond knowledge of subject matter per se to the dimension of subject matter knowledge for teaching*' (Shulman, 1986, p. 9).

In his 1987 paper, PCK was separated out as a distinct knowledge type and is placed as one of the seven knowledge domains of teachers. The 7 knowledge domains Shulman proposed include;

- (i) *content knowledge* - this refers to the knowledge and understanding of the central concepts within a subject
- (ii) *general pedagogical knowledge* - these include general strategies that relate to classroom management
- (iii) *curriculum knowledge*, teachers need to be aware of the requirements of the curriculum standards

- (iv) *pedagogical content knowledge* - “that special amalgam of content and pedagogy that is uniquely the province of teachers, their own special form of professional understanding”
- (v) *knowledge of the learners* - teachers need to know the prior learning of their learners and have a good understanding of their diverse abilities and ways of learning
- (vi) *knowledge of educational contexts* - this includes understanding the social, political and cultural contexts reflected in a classroom
- (vii) *knowledge of educational ends, purposes, values and philosophical grounds* - this encompasses understanding the values, historical background and educational expectations of a community. (Shulman, 1987, p. 8)

Shulman saw these seven knowledge domains as minimum requirements for teachers. He proposed that PCK formed part of the knowledge domain of teachers but that PCK was of particular interest because it was a category of knowledge unique to teachers. He further subdivided the category of PCK into 2 components (i) representations and instructional strategies and (ii) student subject specific learning difficulties. The key idea is that this knowledge is different from that of subject specialists. (Shulman, 1987)

From this initial proposal, researchers set about the task of defining exactly what is meant or what comprises teacher PCK. This proved to be a difficult undertaking because much of this knowledge is internal and teachers don't always recognise that they have the specialised knowledge. As an example of the type of work done to try and unpack this concept Morine-Dersheimer and Kent (1999) presented a flow diagram of the facets and interconnections they thought made up a teacher's PCK. This is shown below in Figure 1. and includes the interaction between classroom management and organisation, instructional models and classroom communication as part of a teacher's general pedagogical knowledge, but argues that with reflection a teacher is able to develop context specific pedagogical knowledge and this then becomes part of her

personal pedagogical knowledge, which is impacted by her personal beliefs and experiences. This flow diagram gives a sense of the complex and personal nature of PCK.

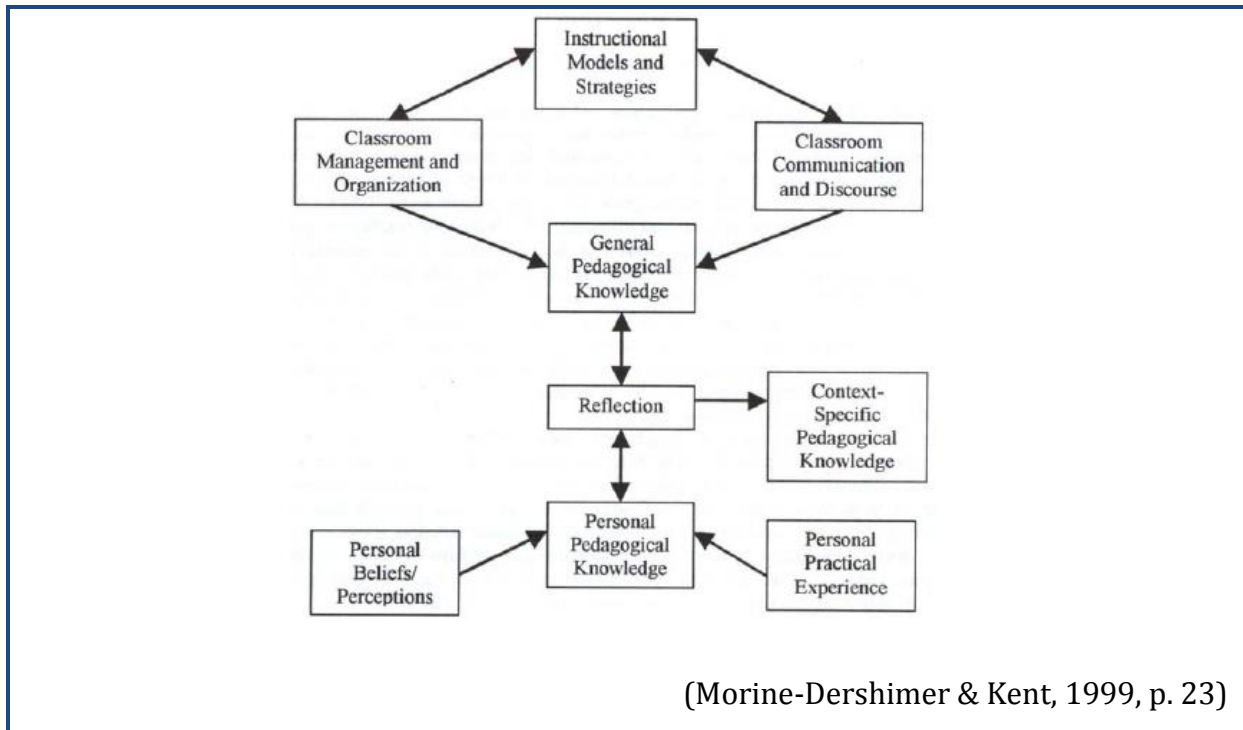

Figure 1: Flow diagram from Mornine-Dershimer and Kent describing the facets of PCK

Since the initial concept of PCK was introduced by Shulman there have been several studies and discussion regarding its nature and it has still remained somewhat of a 'hidden concept' (Kind, 2009) However, at the PCK summit held in, Colorado October, 2012 a level of consensus was reached with regard to the definition of PCK. Gess-Newsome (2014) outlines these definitions as;

- **Personal PCK is the Knowledge of, reasoning behind, and planning for teaching a particular topic in a particular way for a particular purpose to particular students for enhanced student outcomes (Reflection on Action, explicit)**
- **Personal PCK and Skill is the act of teaching a particular topic in a particular way for a particular purpose to particular students for enhanced student outcomes (Reflection in Action, tacit or explicit) (Gess-Newsome, 2014, p 10)**

Gess-Newsome (2014) highlights 3 aspects of these definitions. Firstly, that PCK is an internal and personal construct and that it is context specific and cannot be generalised. The second aspect is the time periods during which PCK is employed. The first time period is when a teacher prepares and considers instructional strategies for a class. This is relatively easy to see and to measure. The second time period is when PCK is employed in the classroom. In a teachers' practice adjustments are made in the classroom depending on the level of engagement of learners', their questions and problems that arise. These adjustments are not as easy to monitor and are encompassed in the second part of the above definition. The third aspect of the definitions is the inclusion of skill level. A teacher may have knowledge of a strategy but may not have the teaching mastery to apply it, thus the expansion of the definition to include PCK and Skill. These definitions are complex but will allow researchers to define which aspect of PCK they are observing or measuring (Gess-Newsome J. , 2014).

Considering the internal and tacit nature of PCK but its potential to impact quality teaching, researchers needed ways to show and potentially measure PCK. In order to do this a number of researchers proposed models of PCK to try to unpack the complex nature of PCK and make it observable. The following section will describe some of these models.

2.3. Models of PCK

Models provide a way to tease out components of complex phenomena providing a means for the relationships between various aspects of the phenomena to be conceptualised. Several models for PCK have been proposed since Shulmans' 1986 and 1987 papers but I have selected only a few of the major models, which mark changes in thinking. I have focused on the models that have included content knowledge, curricular knowledge, instructional strategies and learner knowledge. These factors become important later in my project as they form the framework for the development of the assessment tools to be designed. There are other factors such as teacher beliefs, cultural context, assessment knowledge, school environment, curricular knowledge, general

pedagogical knowledge to name just a few that form part of teacher knowledge but these fall outside of the scope of this project. The Topic-specific model that forms the conceptual framework for this project (see section 2.5) does not include these factors because the aim is to specifically measure how teachers transform content knowledge. Narrowing the scope to the transformation of content knowledge allows for a clearer focus for this study.

The terms of 'Content Knowledge' (CK) and 'Subject Matter Knowledge' (SMK) are used in similar ways but are viewed slightly differently between authors. Shulman assumed that the content knowledge of a novice teacher and an experienced teacher is essentially the same and includes concepts that learnt within an academic environment. He contended that subject matter knowledge (SMK) was a little different from Content Knowledge and included knowledge of science teaching. He proposed that a teacher has to '*know that*' and '*know why*'. The '*knowing that*' includes the content, theorems, and processes but the '*knowing why*' is the understanding why phenomena occur in the way they do (Shulman, 1986). According to Cochrane and Jones (1998) SMK is the knowledge of facts, ideas and theorems relating to scientific concepts and does not include any knowledge of teaching that Shulman included. This overlapping of the same terms, but with different meanings, is one of the reasons why it is difficult to tease out PCK concepts. For the purposes of this study the term of content knowledge (CK) is used and refers to the ideas, theorems, facts etc. around a topic i.e. anything that may be found in a textbook.

Kind (2009) reviewed several major models in her article in which she attempts to clarify the potential value of the construct of PCK for teacher education. Kind draws on the two broad categories of integrative and transformative PCK, proposed by Gess-Newsome, to organise the development of PCK models. A pictorial representation is given in Figure 2.

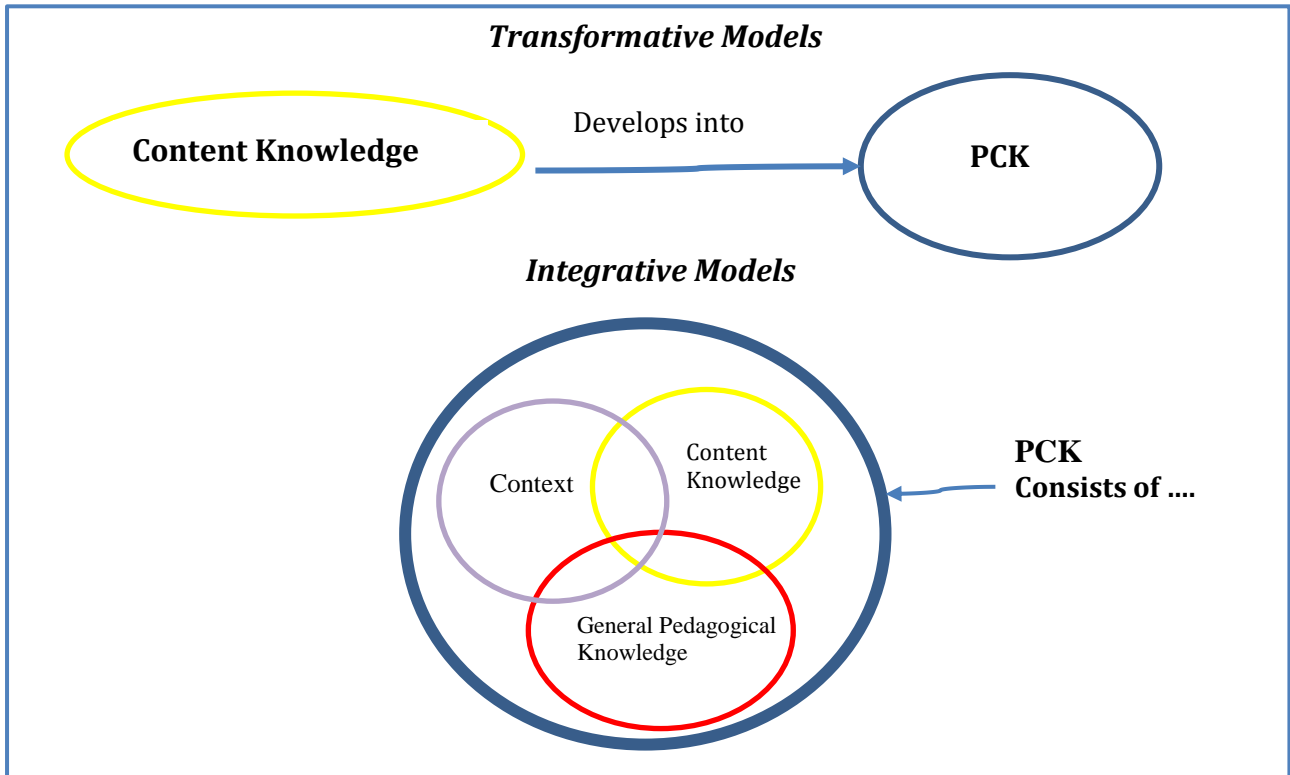

Figure 2: A representation of the difference between the transformative and integrative models of PCK

The transformative models view content knowledge as distinct from PCK. The content knowledge is transformed into pedagogical content knowledge. As illustrated in the diagram, content knowledge is distinct from PCK but has the potential to be developed into PCK.

The integrative types of models have teachers' content knowledge (CK) as a sub-level of knowledge within their PCK (Kind, 2009). The Integrative models view PCK is seen an amalgam of teachers' knowledge of context, general pedagogical knowledge and content knowledge. These knowledge sets overlap and integrate to form a teachers' PCK. The diagram above (Figure 2.2) is my attempt to clarify the distinction. It serves as starting point to organise the development of the framework for PCK. The two broad categories of transformative and integrative are not clear-cut and there are points of overlap, which again reiterates the point that PCK is multi-faceted, complex, and difficult to describe explicitly.

The flow diagram (Figure 3) below is an attempt to organise the process of development of the theoretical framework of Pedagogical Content Knowledge by illustrating the development of transformative, integrative and topic specific models of PCK. The flow diagram is presents a summary of the key points of some of the PCK models and shows the inter-relations between the various models. A more detailed description of some of the models follows after the Figure 3.

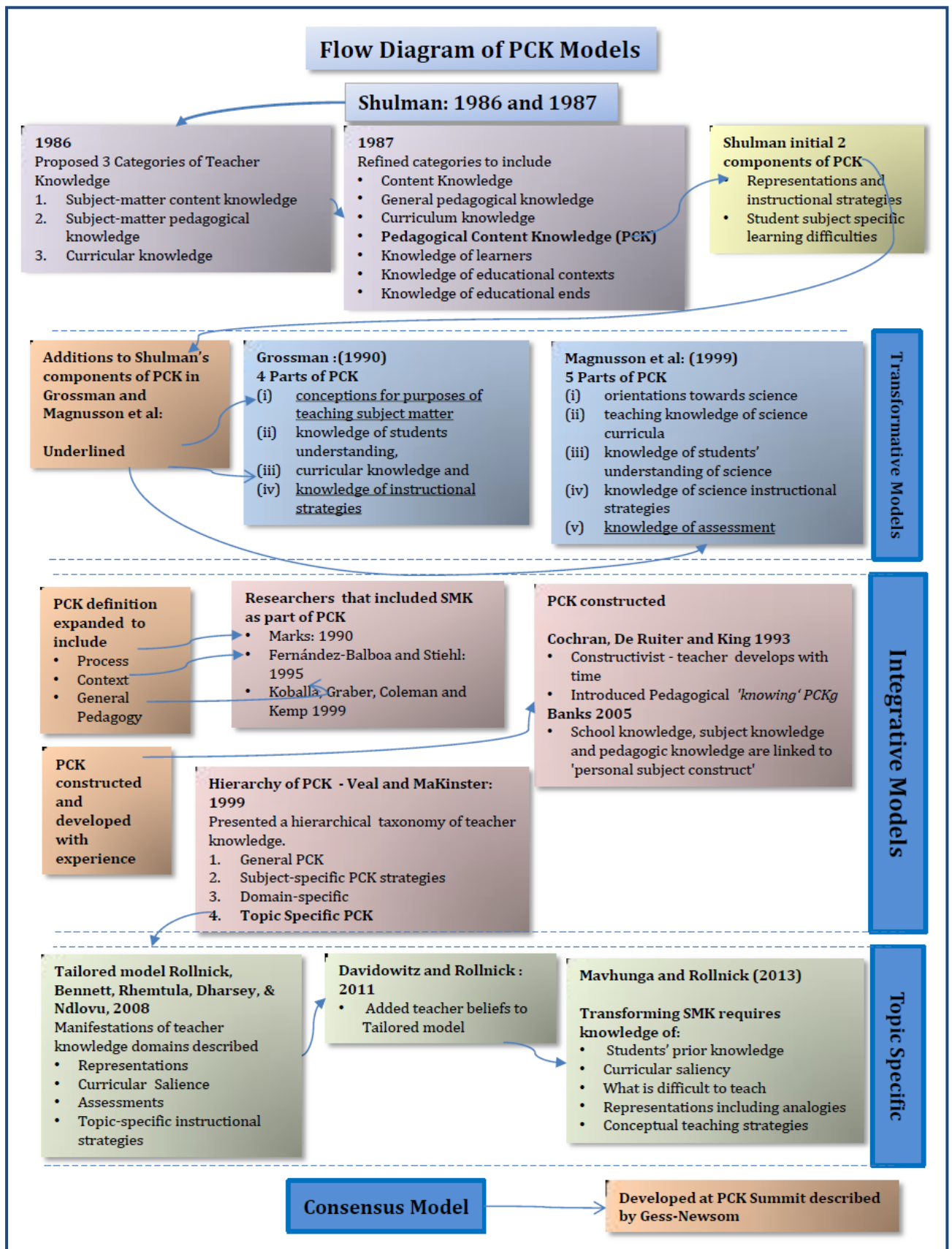

Figure 3: A flow diagram of the development of models of PCK

The transformative models that arose directly from Shulman’s proposal focused on developing progressively more detailed descriptions of PCK (2nd Tier of the flow diagram - Figure 3). The two initial models that arose from and extended Shulman’s work ,were Grossman (1990) and Magnusson, Krajcik and Borko (1999). The Grossman and Magnusson *et al* models of PCK are shown as a comparison in Figure 4. These two models also show the increasing complexity of the conceptualising PCK from Shulman’s initial 2 category definition of PCK.

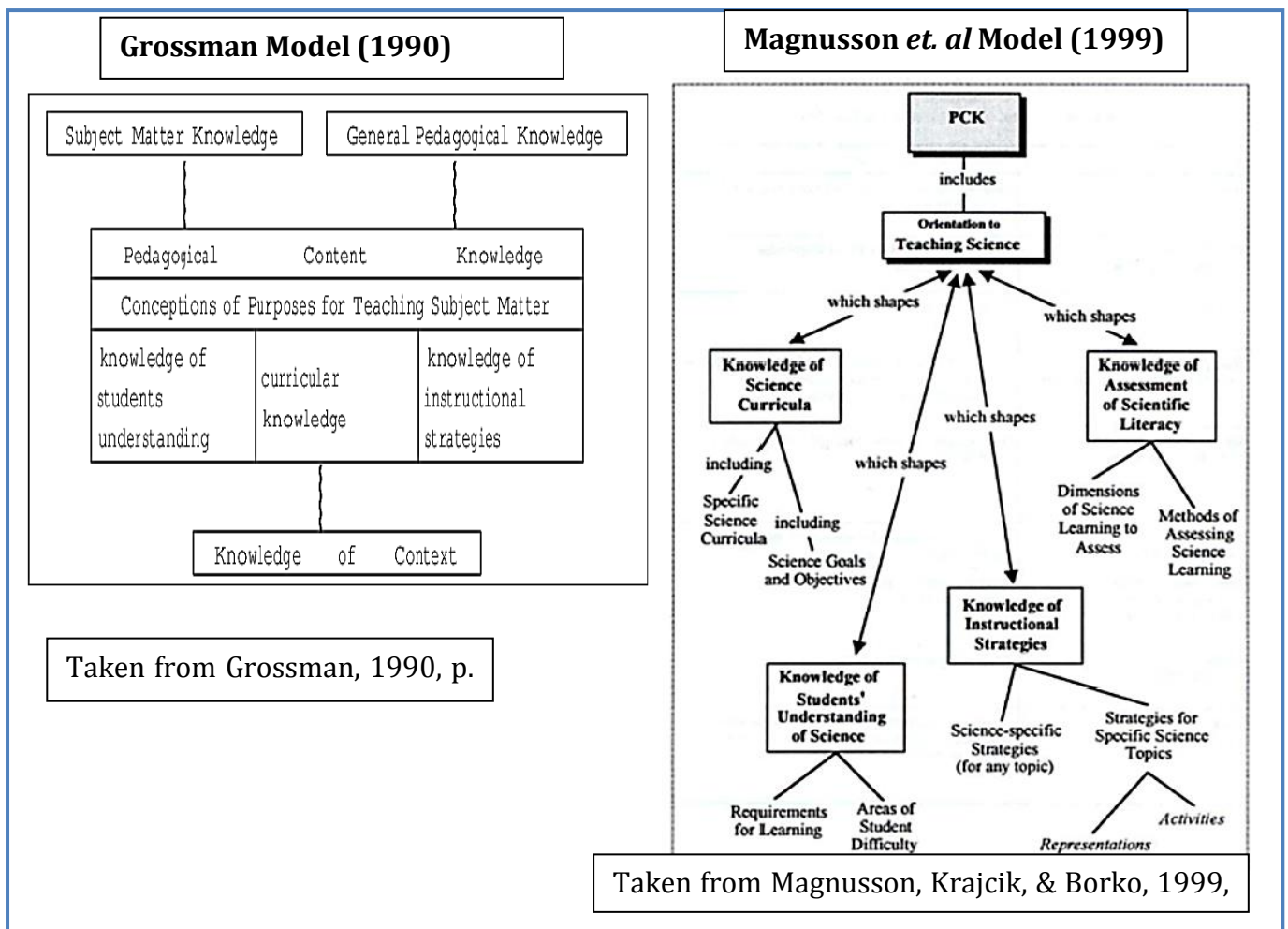

Figure 4: Representations of the Grossman and Magnusson *et. al* Models of PCK

Grossman’s model (Figure 4) extended Shulman’s model and added knowledge of context to subject matter knowledge and general pedagogical knowledge.

These knowledge types were regarded as the sources of PCK. She then further sub-divided PCK into 4 parts;

- i. *conceptions for purposes of teaching subject matter* – which are the beliefs held by the teacher with regard to nature and importance of the content being taught
- ii. *knowledge of students understanding*, - this included knowledge of student preconceptions and misconceptions
- iii. *curricular knowledge* - includes an understanding of the content and sequencing of a curriculum
- iv. *knowledge of instructional strategies* - this refers to knowing what strategies and representations are required for particular topics

Developing on the work by Shulman and Grossman, Magnusson, Krajcik and Borko (1999) conceptualised PCK as consisting of five components (shown in Figure 4.), these include

- i. *orientations towards science teaching* - this category is similar to Grossman’s conceptions for the purposes of teaching subject matter
- ii. *knowledge of science curricula* – this is similar to Grossman’s category and includes an understanding and knowledge of the goals and objectives in science curricula
- iii. *knowledge of students understanding of science* –
- iv. *knowledge of science instructional strategies* –
- v. *knowledge of assessment* - this is an addition to Grossman’s model and refers to a teacher’s ability to decide what material to assess and when it should be assessed.

These two components parallel Grossman's second and fourth categories

In the integrative models, shown on the 3rd tier of Figure 3., PCK is seen as part of the collective knowledge that teachers have in order to practice. Within this integrated ‘package’ of knowledge, transformation of knowledge can occur. Kind (2009) grouped Marks (1990), Cochran, De Ruiter and King (1993), Fernández-Balboa and Stiehl

(1995), Veal and McKinister (1999), Koballa, Gräber, Coleman and Kemp (1999) and Banks, Leach and Moon (2005) as integrative. Within these models, there are further refinements of description of PCK. In all the developments of the PCK models, very little is removed from previous models, instead, the descriptions become more complex and interwoven. Marks (1990) expanded instructional strategies to instructional processes and student difficulties to knowledge of student misconceptions. Fernández-Balboa et al. added knowledge of context as a significant component of PCK. Koballa et al (1999) distinguished between general pedagogical knowledge and PCK. Teachers have a broad knowledge of how to manage a classroom situation but PCK specifies strategies for the delivery of specific content.

Within the integrative group that described PCK there are authors who began to describe how this knowledge was constructed. Cochran, DeRuiter, & King, (1993), drawing from the constructivist theoretical perspective, proposed that knowledge is developed over time because of active experiences and that includes teachers' knowledge. They proposed the concept of pedagogical 'knowing', which they saw as deeper than 'mere content', but as a teacher's integrative skill to bring all facets together is required for effective teaching. Banks et al. (2005) added a new category of '*school knowledge*', which distinguishes between knowledge of a discipline and how it is used within a school context. A teacher's school knowledge acts as a bridge between subject and pedagogic knowledge (Kind, 2009, p. 179). Banks abandoned Shulman's notion that a teacher transforms knowledge for teaching instead, he proposes that teachers learn how to present knowledge because of their classroom context; it is a much more dynamic and fluid process than the mechanistic process of the transformative models.

Veal and Makinster (1999) not only conceptualised SMK as integrated within PCK, they also proposed that there was a hierarchy to the knowledge. A four level hierarchy of PCK was proposed by Veal starting with (i) General PCK, (ii) Subject Specific Strategies, (iii) Domain Specific and (iv) the highest-level Topic Specific Strategies. The distinction is most evident for 'domain-specific' and 'topic specific' strategies. Domain specific

relates to specific strategies of how to teach a subject such as organic while topic specific strategies are even finer and refer to how a specific teacher based on their background and experience, may teach a specific topic for example a biology teacher might approach teaching organic chemistry differently from a chemistry trained teacher. Each might have similar knowledge bases but other perspectives will influence how they approach a topic. The categories of transformative and integrative become blurred when knowledge is viewed in this way instead it could be argued that both processes of transformation and integration occur as a teacher develops PCK. How an individual teachers' PCK is constructed depends on the context of the teacher, teaching environment and the topic being taught.

The importance of these conceptualisations of PCK is that the definition became finer and the idea that PCK varies for different topics was presented. The concept of Topic Specific PCK is central to this project and is the conceptual framework for this study. The Topic Specific models are described in more detail in section 2.5 but in order to place these models in context with the developing conceptualisation of PCK, an overview is given here. The Tailored PCK model (Rollnick, Bennett, Rhemtula, Dharsey, & Ndlovu, 2008) included similar internal knowledge domains as Cochran *et al.* (1993) but included description of how these teacher knowledge domains would be manifested and could be observed. They identified 4 manifestations of PCK, namely; (i) Representations, (ii) Curricular Saliency, (iii) Assessments and (iv) Topic specific instructional strategies. In the Davidowitz and Rollnick study (2011) an additional level of teacher beliefs was added to the Tailored model of PCK. The Mavhunga and Rollnick model (2013) of Topic Specific PCK is presented as a separate entity that arises from subject matter knowledge and is transformed in a specific way for a specific topic. According to Mavhunga and Rollnick (2013) transforming subject matter knowledge into topic specific PCK requires knowledge of learner prior knowledge and misconceptions, being aware of curricular saliency, having a clear idea of what is difficult to teach, knowing what representations and analogies are needed to convey concepts and conceptual teaching strategies. Each of these transformative mechanisms will be discussed in detail in the theoretical framework section.

At the recent PCK Summit, a consensus model of PCK was developed that draws on many of the concepts discussed and their inter-relations. The Consensus model is described by Gess-Newsome (2014) and is the most recent model of PCK. This model attempts to show that teacher professional knowledge and skill, which encompasses PCK, is developed through feedback mechanisms. Each component of their model informs and impacts all other components. This model includes the impact of student outcomes. The starting points are teacher professional knowledge bases which inform topic specific professional knowledge. When this knowledge is brought into a classroom the interaction has the potential to cause an adjustment in the teacher’s professional knowledge base. That adjustment is made through amplifiers and filters of teacher beliefs, orientations, prior knowledge and context. The model also recognises that students come with similar amplifiers and filters, which influence how the knowledge transferred is received. Student outcomes are not automatically present because of instruction but student outcomes can mediate a teacher’s thinking around classroom practice, topic specific professional knowledge and curricular knowledge. A representation of this model is given in Figure 5. (Gess-Newsome, 2014)

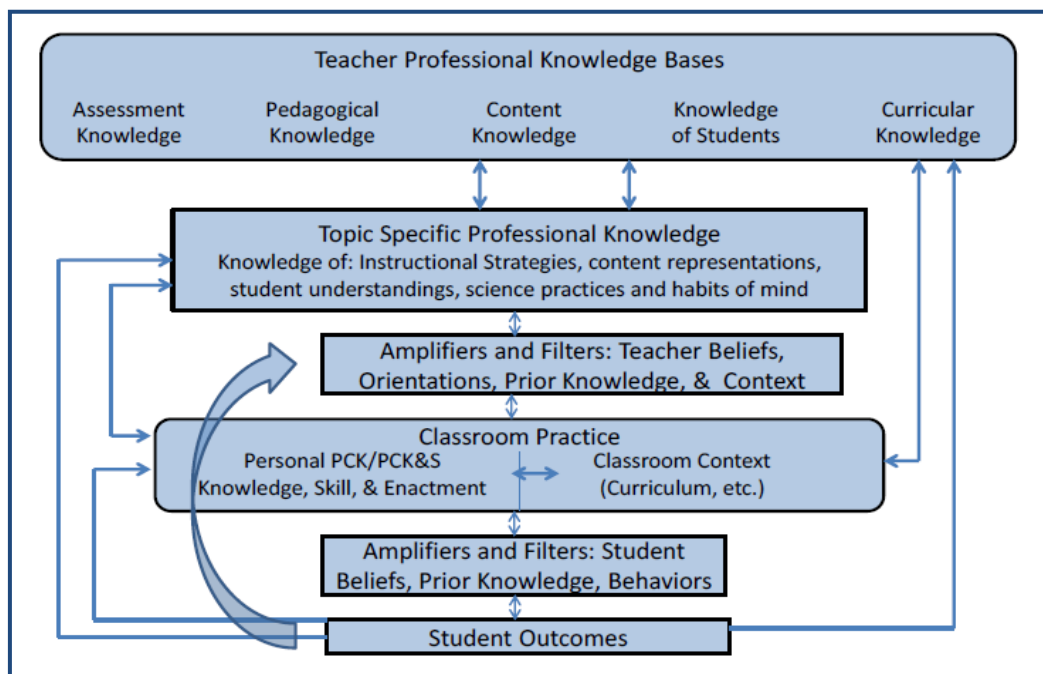

(Gess-Newsome J. , 2014, p. 3)

Figure 5: Consensus model for teacher professional knowledge and skill including PCK and influences of classroom practice and student outcomes

While student outcomes are not the focus of this study, ultimately the hope is that a better understanding of PCK will improve science education. In order to be able to convey and portray PCK, it needs to be clearly described and measured. The next section will describe strategies undertaken to achieve this. The models of PCK expose the complex nature of PCK and provide a platform to begin to make PCK visible.

2.4. Capturing and measuring PCK

The models of PCK provide a conceptual background and illustrate the difficulty of defining the complex and fluid nature of teacher knowledge. It is difficult to pinpoint PCK, it is not something concrete that can be shown to anyone. It is even more difficult to say which teacher has stronger and which has weaker PCK.

2.4.1. Capturing PCK

One of the ways that there has been an attempt to capture PCK is through the development of content representations or CoRes by Loughran, Berry and Mulhall (2006) and Bertram and Loughran (2011). A CoRe is a means to organise teacher knowledge and PCK. It starts with extracting what the 'Big Ideas' are within a certain topic. The 'Big Ideas' are conceptual, almost non-negotiable concepts required for understanding a certain topic. Then, with each 'Big Idea', the following questions are asked.

- 1. What do you intend the students to learn about this idea?*
- 2. What else do you know about this idea that you do not intend your students to know yet?*
- 3. Why is it important for students to know this?*
- 4. Difficulties/limitations connected with teaching this idea?*
- 5. Knowledge about student thinking which influences your teaching of this idea?*
- 6. Other factors that influence you're teaching of this idea?*

7. *Teaching procedures and particular reasons for using these to engage with this idea?*

8. *Specific ways of ascertaining student understanding or confusion around this idea?*

(Loughran *et al*, 2006)

A CoRe is one method to extract teacher reasoning, however, researchers have designed other tools in mathematics (Riese & Reinhold, 2009), in technology (Rohaar, Taconis, & Jochems, 2009) and in science (Park, Jang, Chen, & Jung, 2011). Mavhunga and Rollnick have developed a tool to extract Topic Specific PCK in electrochemistry. This study builds on their work to extract and rank teachers TSPCK in a different topic, namely electric circuits.

2.4.2. Measuring PCK

As described above, researchers do not agree on the exact nature of the construct of PCK, which makes it difficult to measure it. One area of research that has helped to expose the nature of PCK explicitly and in a measurable manner is in the comparison of pre-service teachers with experienced teachers. Davis (cited in Baxter and Lederman, 1999) in her study of pre-service primary teachers made the general observation that even when a pre-service teacher had a good science background, their instruction was flawed. Having a good knowledge of a subject is a starting point, but it does not automatically follow that good instruction will follow. The implication of this work is that there is practice that could be termed 'good' PCK or alternatively 'bad' PCK. This value judgement implies that there is something inherently measurable about PCK.

PCK cannot be directly observed in the classroom because it is an internal construct of a teacher. In the short timeframe of an observation, some of a teacher's PCK for that particular context could possibly be observed but it will only be a sliver of that teacher's PCK. The options that a teacher has available to her and chooses not to make use of are also an important part of a teacher's PCK. Teachers are not always able to articulate their cognition process, which is another reason why PCK is a difficult construct to assess (Baxter & Lederman, 1999).

Despite the difficulties of measuring and observing PCK, researchers have employed several techniques to record PCK. Baxter and Lederman categorised the techniques used to measure PCK into three groups; namely (i) convergent and inferential techniques, (ii) concept-mapping, card sorts and pictorial representations and (iii) multi-method evaluations. The convergent and inferential techniques include short answers and multiple-choice items. While multiple-choice tests are easy to administer and are not too time consuming for the respondents, there are some concerns with the use of this methods. There is an assumption with these tests that there is a correct answer, which is not always the case in the context rich environment of a classroom. Multiple-choice items tend to be too simplistic (Baxter & Lederman, 1999).

Researchers have made use of concept mapping to elucidate knowledge structures and the perceived connections between concepts. Morine-Dersheimer & Kent (1999) used concepts maps to measure changes in thinking of pre-service teachers. A criticism of concept mapping is that they are restrictive because they require hierarchical organisation and do not show the multiple relationships and interconnections involved in PCK. There is some concern as to what the exact nature of the knowledge represented in a concept map is, but both Morine-Dersheimer *et al* (1999) and Gess-Newsome (2002) suggest it is a potential tool to provide teachers feedback on their knowledge structure.

In order to overcome some of the issues with each of the above techniques, it was decided to use a mix of the above techniques, drawing on each of the strengths but minimising the weaknesses. In the final assessment tool, multiple choice options, semi-closed response questions, concept maps, inferential techniques, pictorial representations and open response items are all used. However, having various techniques to measure does not solve the problem of what to measure. What researcher's measure is closely tied to their model of PCK?

The PCK models described earlier have been used to help to describe what is being measured. The tool designed by Lee *et al* (2007) used two knowledge components of student learning and instructional strategies. Park et al designed their instrument using

all the components of the Magnusson *et al.* model. However, even though these components of PCK help to define a point of assessment, they remain broad and difficult pinpoint. Focusing on a particular topic refines the focus to how teachers transform content for a specific topic. Geddis & Wood, (1997) identified definable and measurable knowledge areas that a teacher uses to transform knowledge. These include knowledge of: learner prior knowledge, subject matter representations, instructional strategies, curricular materials, and curricula saliency.

Park, Jang, Chen, & Jung (2011) designed and validated a PCK rubric using two parameters; of *Knowledge of student understanding* (KSU) and *Knowledge of instructional strategies and representations* (KISR). While only using two components of teacher knowledge may limit what was assessed, the value of this work was the idea that PCK type knowledge could be categorised and ranked. Aydenziz and Kirbulut (2011) designed an assessment tool to measure pre-service teachers PCK in electrochemistry, using 3 categories namely, assessment, curriculum and instruction. Their focus on a specific topic is a useful idea for this study but it is missing prior knowledge of learners and misconceptions they might hold.

The Topic Specific Pedagogical Content Knowledge (TSPCK) model developed by Mavhunga and Rollnick (2013) includes 5 categories and has the focus of a single topic. Their model has been successfully used to design and validate an assessment tools in electrochemistry (Ndlovu, 2014). This model is also being used to design tools in stoichiometry, acids and bases and chemical bonding that have not been published yet. This TSPCK model has been selected as the conceptual framework for this project because it clearly defines 5 components included in teacher reasoning and uses the specific focus of a single topic which makes measurement possible and manageable. The process of development used by Mavhunga and Rollnick broadly followed the 'rational method', a process

2.5. Conceptual Framework

The Topic Specific Model designed by Mavhunga (2012) to assess teachers' PCK in chemical equilibrium provides a framework to extract teachers' PCK within a specific topic. While they acknowledge that other factors such as knowledge of context, students, and pedagogy contribute to a teachers' PCK, it is not the focus of their model. Their particular point of interest is how teachers transform Subject Matter Knowledge (SMK) into material for teaching. Two of the models that were precursors to the TSPCK model of Mavhunga and Rollnick and helped to develop its structure were the Tailored model (Rollnick *et al*, 2008) and the Modified PCK model of Davidowitz and Rollnick (2011).

2.5.1. Foundational models of the TSPCK model

The Tailored and the Modified PCK models have a common thread, namely that Pedagogical Content Knowledge (PCK) is developed through transforming Subject Matter Knowledge (SMK) or Content Knowledge (CK). The internal knowledge of the subject domain is transformed into something that can be evidenced in teachers' practice. In the Tailored Model of PCK by Rollnick *et al*. (2008) (shown in Figure 2.6), the internal knowledge domains are drawn from Cochran *et al*. (1993) while the manifestation on the top part of the model are drawn from sources such as Geddis and Wood (1997). The strength of this model is that it separates the internal constructs from the external manifestations but recognises that the internal constructs are causal for the external evidence. In the Davidowitz & Rollnick (2011) model, that was developed studying the practices of an accomplished organic chemistry lecturer, an additional layer of 'Teacher Beliefs' was added, which also influences teacher knowledge domains. The schematic representation of this model is included in Figure 6. As a comparison with the 2008 Model

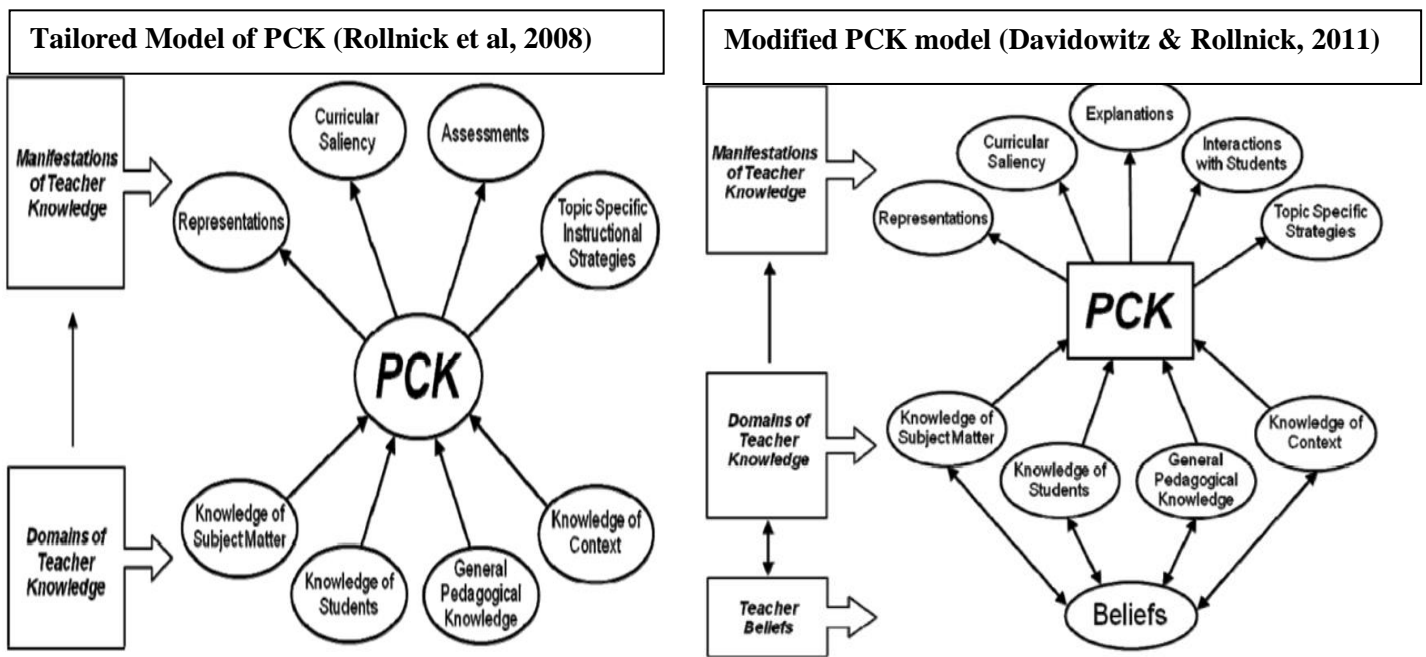

(Rollnick, Bennett, Rhemtula, Dharsey, & Ndlovu, 2008)

(Davidowitz & Rollnick, 2011)

Figure 6: Schematic representation of the Tailored PCK model (Rollnick et al, 2008) and the Modified PCK model (Davidowitz & Rollnick, 2011)

An important component of both these models is the critical placement of teacher knowledge and specifically content knowledge (CK).

2.5.2. The connection between Content Knowledge (CK) and Pedagogical Content Knowledge (PCK)

Content Knowledge (CK) as previously defined, for the purposes of this study includes ideas, theorems, facts etc. or anything that may be found in a science textbook. Teacher content knowledge has been found to be crucial in the development of PCK (Ball, Thames, & Phelps, 2008). Ball et al in their study of mathematics teaching showed that there was a distinction between ‘pure’ content knowledge and knowledge for teaching. However, good content knowledge is a starting point to develop PCK, when a teacher begins to practise the act of delivery in a classroom and assessing will give her feedback as to what is working and what is not. The teacher may adjust, change strategies, re-assess, use a different analogy or any number of options based on the interaction with her students and their work. This feedback, reflection, development loop is what was

described in the Consensus Model of PCK. This implies that an experienced teacher has wider repertoires of strategies to respond to the classroom situation, but that without the initial content knowledge there is little chance of even beginning the journey of developing PCK. This is relevant in the South African context because if this tacit knowledge base could be made explicit, pre-service teachers could have the benefit of this knowledge.

The Topic Specific PCK model of Mavhunga and Rollnick (2013) recognises as crucial the starting point of content knowledge. This content knowledge is then transformed and this transformation process is observable and measurable, for a specific topic. This topic specific nature of PCK is confirmed by Aydin (2012) who studied two chemistry teachers teaching electrochemistry and radioactivity. He found that the PCK varied depending on the topic being covered. A similar conclusion was drawn by van Driel, de Jong & Verloop (2002) in their studies of high school chemistry teachers. There is general agreement in the literature that teaching knowledge is topic specific (Geddis, 1993, Loughran, Berry, & Mulhall, 2006).

The TSPCK model of Mavhunga and Rollnick was selected as the conceptual framework for this study. The development of their TSPCK assessment tool broadly followed the 'rational method' of construction, a process outlined by Oosterveld and Vorst (1996). Their method emphasises content validity, and uses empirical data and judgements of experts in the construction of items (Rohaani et al, 2009). The next section outlines the components of this model.

2.5.3. Topic Specific PCK

Mavhunga and Rollnick (2013) emphasise the transformation of CK for the development of PCK. The other components of knowledge of context, knowledge of students and general pedagogical knowledge are recognised as impacting on the development of PCK but are not the focus of the model or this study. A distinction is

made between TSPCK and PCK. TSPCK is a sub-set of PCK and refers to the unique knowledge a teachers possesses about a topic that enables her to transform the content knowledge into something accessible for her students. A schematic representation of the TSPCK model designed by Mavhunga (2012) is given in Figure 7.

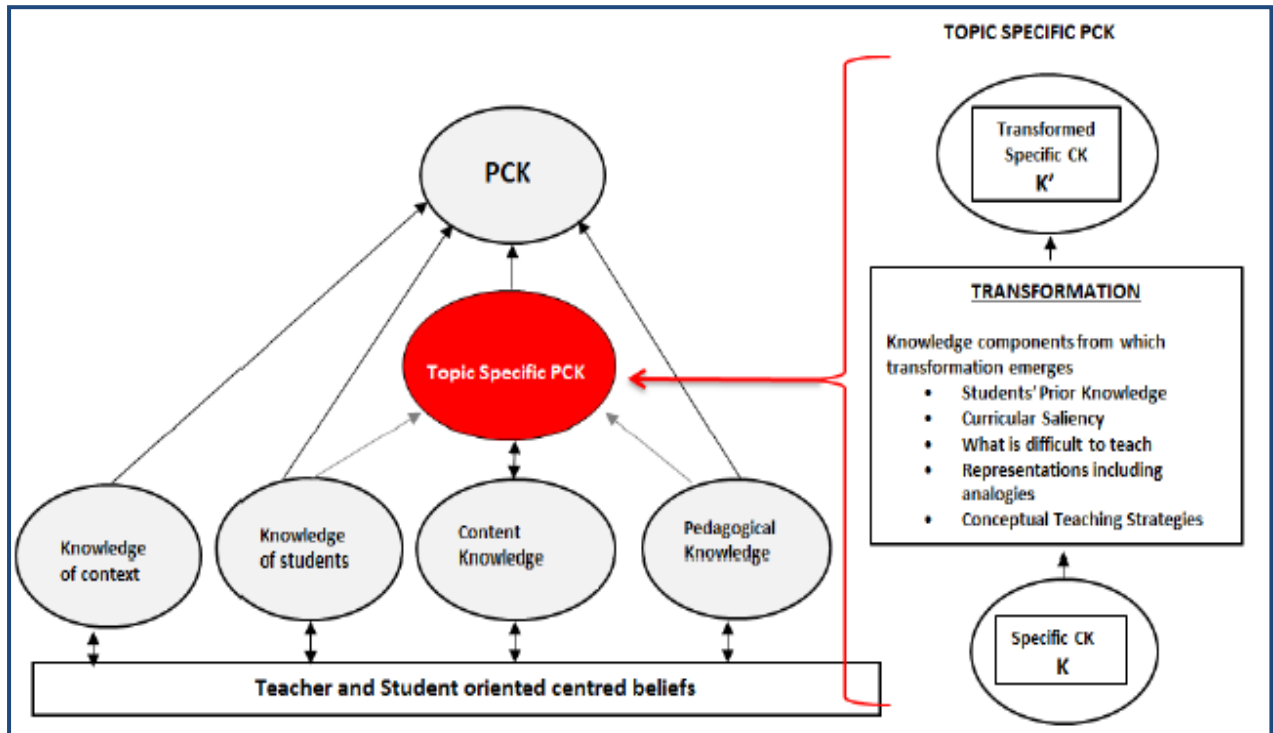

(Mavhunga, 2012, p. 191)

Figure 7: Schematic diagram of the Topic Specific Model of Mavhunga (2012)

In this model it is recognised that the components of knowledge of context, knowledge of students and pedagogical knowledge, underpinned by teacher and student belief, all feed into and form teacher PCK. However, the focus of this model is the transformation of CK. They differentiated between the starting Specific CK of a teacher, which they coded as K. This content knowledge then undergoes a transformation process and the resulting knowledge they termed Transformed Specific CK, which is coded as K'. The space between K and K' is where the transformation process occurs; this transformation process is termed Topic Specific PCK (TSPCK). They identified five components of this transforming process, namely;

- ***Learner prior knowledge***

This includes any prior knowledge a learner has, any misconceptions relating to a topic, as well as her social and cultural context.

- ***Curricular saliency***

This encompasses the decisions a teacher makes regarding what to include in a teaching programme, what to leave out, and what is appropriate for a particular grade level.

- ***What is difficult to teach***

There are several things that may make a topic difficult to present, these could include misconceptions of the learners or conceptual difficulties within a topic. It could also include environmental concerns such as lack of resources, overcrowding etc.

- ***Representations and analogies***

Any picture, graph, story, model etc. that is used to aid understanding is included in this category. A teacher who is aware of the needs of her students and has good understanding of whatever concepts are involved will have a range of representation and analogies that she could draw on.

- ***Conceptual teaching strategies***

This category encompasses all the above categories and describes what teaching strategies a teacher employs to develop learners' understanding of the correct scientific concepts.

These categories form the basis for the design of the assessment tools for this project. Evidence of reasoning within each of these categories is the data that will be analysed, categorised and ranked. The topic specific nature of the Mavhunga and Rollnick (2013) model is clear, so an understanding of the specific conceptual and content difficulties teachers and students experienced within electric circuits needs to be understood before commencing with the design of the two assessment tools. The next section will

outline the models for understanding electric circuits and common misconceptions held within this topic.

2.6. Electric Circuits conceptual concerns

The topic selected for the design and validation of a TSPCK assessment tool is electric circuits. The concepts involved in the teaching of electrical circuits are particularly problematic because they are highly abstract and dependent on the extensive use of analogies. Electricity is regarded as central in most physics curricula at all grade levels. (Mulhall, McKittrick, & Gunstone, 2001).

Two themes arise from the literatures that are relevant for this study. Firstly the nature of misconceptions held by students and teachers alike. The second theme is how it is best to confront these misconceptions. Both the nature of the misconceptions and the strategies to confront them are of particular interest to this study. The misconceptions in electric circuits will guide the selection of content for both assessment tools. Items will be selected that will most likely expose the most common misconceptions. The response to and strategies for remediating student misconceptions falls into the realm of TSPCK, thus reviewing some of the possible responses of a teachers and the potential problems with different strategies will provide a good basis for designing items for the TSPCK assessment tool

2.6.1. Common misconceptions with electric circuits

The teaching of electric circuits is regarded by teachers as a difficult but important topic (Gunstone, Mulhall, & McKittrick, 2009) and there is a wealth of literature describing alternative conceptions of electric current. Shipstone, Rhoneck, Karrqvist, Dupin, Joshua & Licht (1988) presented some of the initial research on alternative conceptions of electric circuits. These misconceptions have been shown to be quite stable across different languages and cultural backgrounds (Gaigher, 2014). There is considerable

consensus between researchers of what the most common misconceptions, also sometimes termed pre-conceptions, are. (Engelhardt & Beichner, 2004, Mulhall, McKittrick, & Gunstone, 2001, Summers, Kruger, & Mant, 1998, Wainwright, 2007 and Tarciso Borges & Gilbert, 2010) The misconceptions that appear repeatedly in the literature are summarised in Table 1 below. The table includes the model, a brief description of the misconception and a diagram of how the misconception looks.

Table 1: Summary of misconceptions held with regards to electric circuits

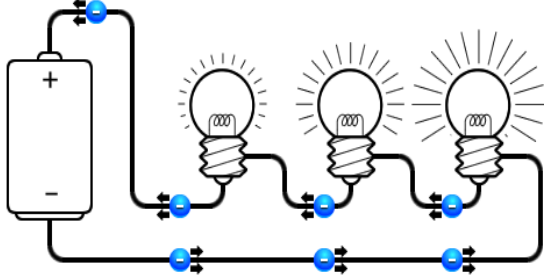
Model	Description	Diagram of the nature of the misconception
1. Sink model or unipolar model	<p>In this model it is thought that only a single connection from a battery is required to for a cell component, e.g. a light bulb, to work.</p> <p>(Sencar & Eryilmaz, 2004, Tarciso Borges & Gilbert, 2010 and Pesman & Eryilmaz, 2010)</p>	 <p>The diagram shows a battery with a single wire connected to one terminal of a glowing light bulb. The other terminal of the battery is not connected to anything, illustrating the misconception that a single connection is sufficient for a circuit to work.</p> <p>http://www.education.vic.gov.au/PublishingImages/school/teachers/teachingresources/discipline/science/continuum/elciccir1.jpg</p>
2. Attenuation / weakening of current/current consumption model	<p>Current is thought to gradually decrease as it flows through a circuit.</p> <p>(Sencar & Eryilmaz, 2004, Wainwright, 2007, Tarciso Borges & Gilbert, 2010 and Pesman & Eryilmaz, 2010)</p>	 <p>The diagram shows a battery connected to three identical light bulbs in a series circuit. The bulbs are drawn with varying sizes of light rays around them, representing the misconception that current is 'used up' and the bulbs become dimmer as the current flows through the circuit.</p> <p>Identical bulbs are thought to become dimmer as the current moves through the circuit</p> <p>http://www.khazar.com/academics/portal/ucsc/2012winter/art22/images/seriescircuit.png</p>
3. Shared current model	<p>Current is thought to be shared equally between all components regardless of how they are connected. In the diagram a person who holds this misconception</p>	<p>Reading 1 = Reading 2 = Reading 3 = Reading 4 = Reading 5</p>

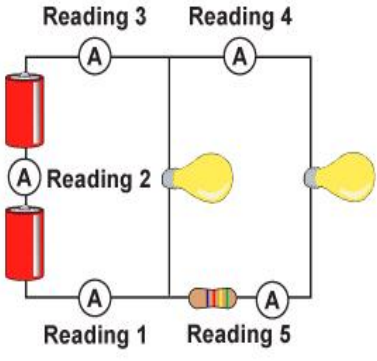
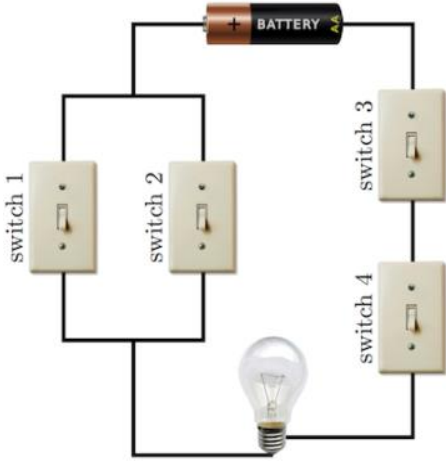
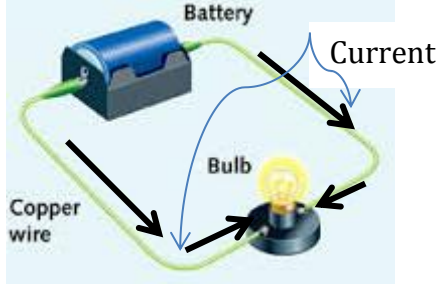
	<p>will say all the ammeter readings will be identical</p> <p>(Sencar & Eryilmaz, 2004 and Pesman & Eryilmaz, 2010)</p>	 <p>http://198.185.178.104/iss/electricity/pages/images/a/a232_2.jpg</p>
<p>4. Local/ Sequential Reasoning</p>	<p>It is assumed that a change in a circuit only affects the circuit components after it. The circuit is not seen as a single inter-related system.</p> <p>(Sencar & Eryilmaz, 2004, Tarciso Borges & Gilbert, 2010 and Pesman & Eryilmaz, 2010, Wainwright, 2007) (Engelhardt & Beichner, 2004)</p>	<p>A student might say switching switch 4 off will have no effect on the bulb because the switch is after the bulb.</p> <p>Or Switching switch 1 off will not affect the globe because it is not part of the parallel connection</p>  <p>http://www.sipta.org/blog/wp-content/uploads/2014/01/circuit.png</p>
<p>5. Clashing Current</p>	<p>Current moves from both battery terminals and meet at the circuit component.</p> <p>(Pesman & Eryilmaz, 2010, and Tarciso Borges & Gilbert, 2010)</p>	 <p>https://encryptedtbn1.gstatic.com/images?q=tbn:ANd9GcQS9E8VC-FHsErF749RkP77BEutDnXI-F--UhF61llAC0PjhOgA</p>

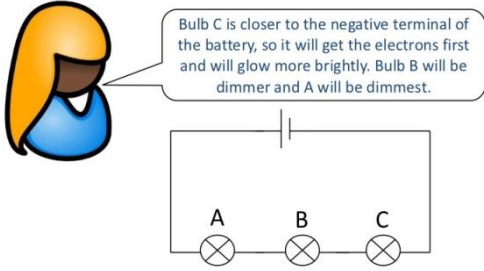
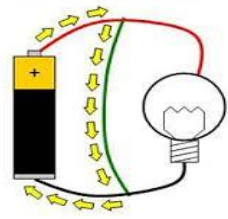
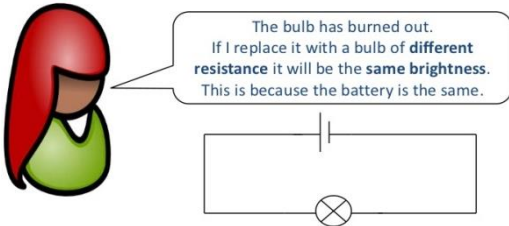
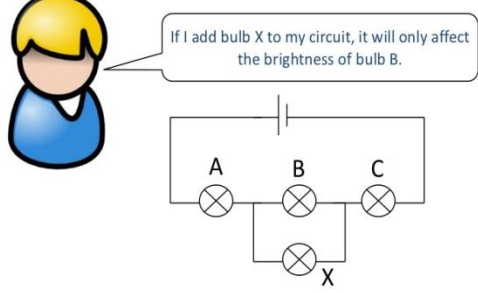
<p>6. Empirical rule</p>	<p>This model implies the further a bulb is away from a battery the dimmer it will be.</p> <p>(Pesman & Eryilmaz, 2010, and Tarciso Borges & Gilbert, 2010)</p>	 <p>http://image.slidesharecdn.com/electricity-120109202214-phpapp02/95/electricity-44-728.jpg?cb=1329894736</p>
<p>7. Short circuit</p>	<p>Wires in a circuit without any circuit components are ignored and thought to have no effect on the circuit.</p> <p>(Pesman & Eryilmaz, 2010, and Tarciso Borges & Gilbert, 2010)</p>	<p>Short circuit</p>  <p>https://encryptetbn1.gstatic.com/i.ages?q=tbm:AND9GcQ21cuMK4iBKJNL_Ok4D6iaqndOg8jMIDn4BFB8g5b5x6AsdAMtiQ</p>
<p>8. Power supply as constant current source</p>	<p>The battery is seen as the source of a constant current, regardless of the circuit components.</p> <p>(Wainwright, 2007, Pesman & Eryilmaz, 2010)</p>	 <p>http://image.slidesharecdn.com/electricity-120109202214-phpapp02/95/electricity-46-728.jpg?cb=1329894736</p>
<p>9. Parallel misconceptions</p>	<p>The effect adding a component in parallel is not understood. The relation of increased resistors in parallel drop the total circuit resistance and increase total current.</p> <p>(Millar & Lim Beh, 2011)</p>	 <p>http://image.slidesharecdn.com/electricity-120109202214-phpapp02/95/electricity-47-728.jpg?cb=1329894736</p>

<p>10. Terminology/ Everyday use</p>	<p>Electricity is part of everyday life and part of everyday vocabulary but sometimes everyday words are used incorrectly in a scientific context</p> <p>(Hart, C, 2008 and Mackay & Hobden, 2012)</p>	<p>For example, “<i>my phone has run out of charge</i>”</p> <p>This implies particles can be lost which isn’t correct what has happened is that all the available energy has been transformed.</p>
---	--	--

The aim of the teacher is to mediate these mental models and to replace them with the correct model which is termed the Ohms’ Law model or the Scientific Model (Tarciso Borges & Gilbert, 2010). In this model current flows around the circuit transforming energy. Current is conserved and clearly differentiated from energy. The circuit is seen as an integrated system, with changes in a circuit affecting the entire circuit.

Teachers use different strategies to confront these incorrect concepts which research have shown can be quite stable (Mackay and Hobden, 2012 and Gaigher, 2014). It is these strategies and the thinking behind them that are of interest to uncover as part of a teachers’ TSPCK.

2.6.2. Potential conceptual strategies with electric circuits

The nature of electric circuit content also means that it is not only the learners but also the teachers who hold misconceptions, which is a one of the categories of the Mavhunga and Rollnick (2013) TSPCK Model. Teachers use a multitude of analogies to make the concepts in electrical circuits accessible to their students. The use of representations and analogies is a category for Topic Specific PCK (Mavhunga & Rollnick, 2012) and the teaching of electrical circuits has a multitude of these informal teaching models and analogies, hence making it potentially a rich source for evaluating teachers TSPCK. The use of analogies, confronting misconceptions, knowing where potential difficulties for students exist, are all pieces of knowledge a teacher can assimilate to form a strategy to mediate her students learning. The category of conceptual strategies in the Mavhunga

and Rollnick TSPCK model, (2013) is particularly relevant in the teaching of electric circuits.

Analogies in electric circuits can include diagrams, hands-on practicals, stories, online simulations, models to name just a few. There is often not agreement about which analogy is effective for teaching electric circuits, for example the flow of water is often used to explain the flow of current. Dupin & Joshua (1987) see this analogy as problematic and potentially a source for new misconceptions, but McDermott & Shaffer (1992) argue that this analogy is an appropriate starting point to explain. Jaakkola, Nurmi, & Veermans, (2011) argue that analogies, which in their study comprised online simulations, are most effective when used in conjunction with hands on experience and some teacher intervention. Hart (2008) highlights a central conflict in the teaching of electrical circuits, namely that the widely accepted model in the scientific community for the electrical flow is the Field Model, but this model is highly abstract and does not lend itself as a good teaching model. These conflicts highlight that the knowledge for teaching is a different knowledge base to pure Physics. Hart (2008) makes the critical point that analogies and models are only effective if the symbolic language they represent is clearly understood by both the teacher and the student and if the teacher is clearly aware where the analogy fails. Being able to articulate where an analogy is flawed and its use is limited is therefore also a part of TSPCK (Grayson, 2004).

Summer's *et al.* (1998) used the teaching of electricity as a case study for qualitatively evaluating the effectiveness of primary school teachers. In their study, they drew theoretically on Shulman's definitions of PCK but were quite broad in their evaluation. They identified some principal outcomes they took as evidence that students had developed conceptual skills. The effectiveness of the teaching of these key concepts was evaluated. The concepts they identified were: the particulate nature of electricity, electrons in the wire already, the 'amount of electricity' is the same throughout the circuit and electrons are pushed by the battery in one direction (Summers, Kruger, & Mant, 1998)

The emphasis of their study was to look at conceptual development and deeper learning of students rather than just procedural knowledge. They concluded (i) the need for the explicit identification of concepts that need to be taught, (ii) the identification of the teaching knowledge required to develop these concepts, (iii) the need to develop an expanded view of the nature of teaching knowledge and (iv) the need for experts to help identify the appropriate knowledge. (Summers, Kruger, & Mant, 1998). The need to develop a more conceptual approach to the teaching of electric circuits correlates with the requirements for TSPCK, reiterating the suitability of the topic of electric circuits for study within the TSPCK model. The categories of TSPCK are potentially a way to make the conceptual strategies to teach electric circuits more explicit. When concepts are made explicit it is possible to explain and communicate them, rather than having teachers learn by trial and error.

2.7. Conclusion

The science education literature is rich with discussion of the nature of PCK and the difficulties of measuring the construct. There is general agreement in the literature that PCK is expressed at the topic specific level and that PCK for one topic is not transferable to another, so the finer construct of TSPCK is a better framework to use for this study. The TSPCK model of Mavhunga & Rollnick (2013) provides a framework to make both the construct and measurement of TSPCK explicit. The topic of electric circuits is conceptually challenging and requires great skill to teach, making it potentially a good topic to see how teachers transform knowledge for teaching. The sites of misconceptions have been extensively researched. This literature provides a good starting point for the design of the TSPCK assessment tool. TSPCK is developed from a base of good content knowledge which necessitates the design of a CK assessment tool. In the next chapter the methodology for approaching the development of the two assessment tools as well as the strategies to ensure validity and reliability will be described.

Chapter 3 – Methodology

In this chapter I discuss the research design and methodology used to design the assessment tools to measure teacher TSPCK in electric circuits. The rationale for the study is also discussed. The steps for the design of the two assessment tools, namely the Content Tool and the TSPCK Tool, are outlined. The procedures for analysing the data derived from the tools are described. The steps for determining the levels of validity and reliability for both assessment tools are outlined. Finally, ethical issues are presented.

3.1. Introduction

There are three components to this study. The first is the design of the two assessment tools. The first of these assessment tools is designed to measure teachers' Content Knowledge (CK) of electric circuits, while the second assessment tool measures teachers' Topic Specific Pedagogical Content Knowledge (TSPCK) i.e. the specific strategies teachers employ to explain electric circuits to their students at Grade 10 level (15-16 years). The second component of the study is to determine the validity and reliability of both assessment tools. The final component is determining the nature of relationship between the CK and TSPCK results.

In this chapter I outline the methodology and rationale used to collate and design the two assessment tools. The first tool, the Content Knowledge Tool, was collated from existing assessments in the science education literature. The second assessment tool, the TSPCK Tool, is the main focus of the study, and the steps for its development are outlined. The steps for collecting and analysing the data from both assessment tools are presented. A crucial component of this study is determining the validity and reliability of both the assessment tools, and the procedures for determining this are outlined. Validity is ensuring that the construct that needs to be measured is the one actually being measured (Messick, 1995). In this case, the constructs are content knowledge of

electric circuits and TSPCK in the teaching of electric circuits. Reliability is a measure of the likelihood of achieving similar results if the tools were applied to a different sample group. Finally, the methods selected to determine the relationship between the CK and TSPCK data are presented.

The flow diagram Figure 8 below outlines the steps involved in this project. There were two parallel processes because it required that two assessment tools be designed, namely the Content and TSPCK tools. The blue blocks of the flow diagram represent the processes involved with the Content Knowledge (CK) assessment tool and the yellow blocks refer to the steps involved with the Topic Specific Pedagogical Content Knowledge (TSPCK) assessment tool. The white blocks refer to processes common to both.

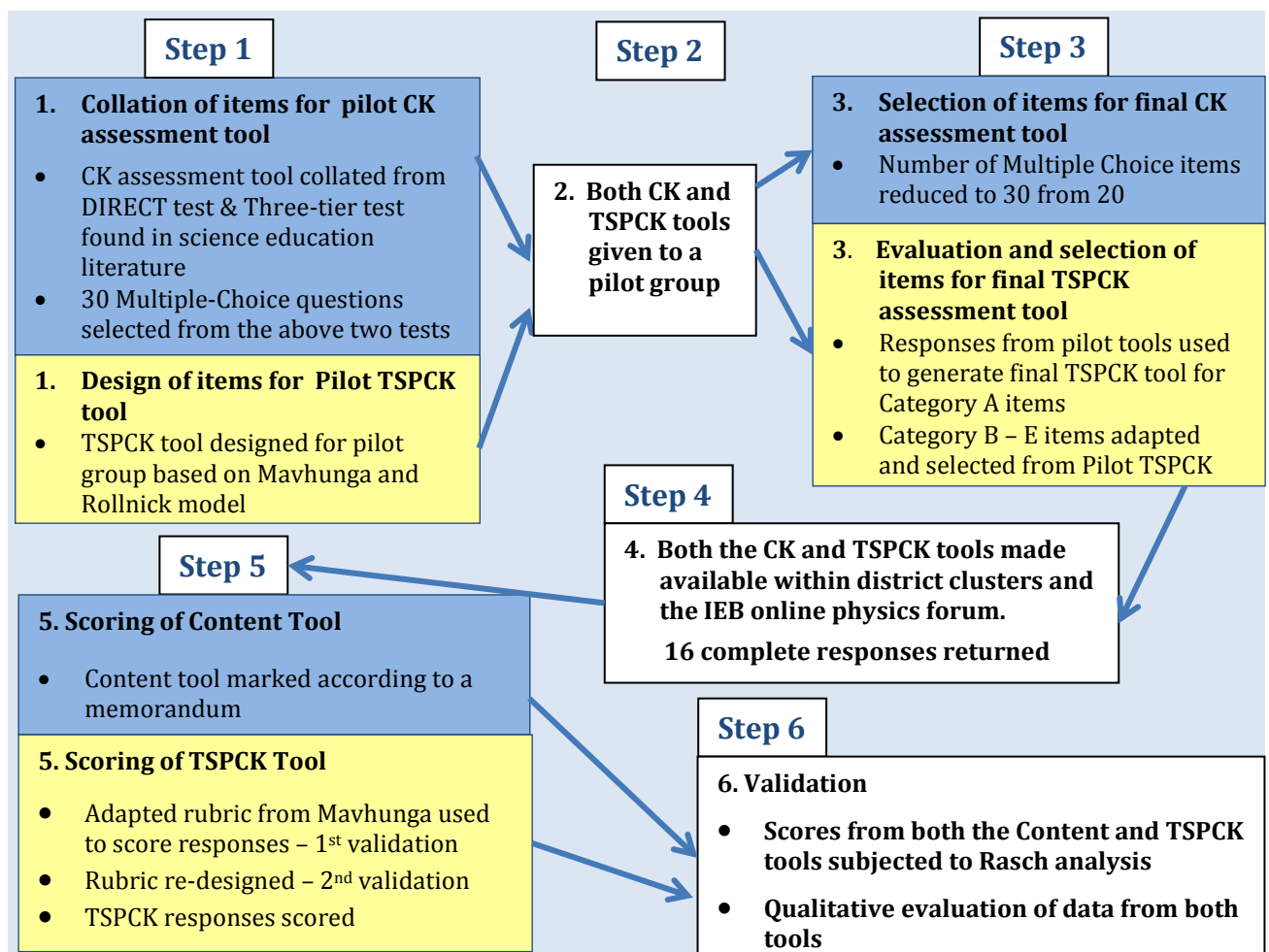

Figure 8: Flow diagram showing steps involved in the design and validation of the CK and TSPCK Tools. The blue blocks relate to the Content Tool, the yellow to the TSPCK Tool and the white to processes common to both.

3.2. Research Methodology

Educational research falls into the domain of social science, which traditionally has had two competing research paradigms. Positivists use quantitative data and take the position that social science research should be objective, measurable and free from the researcher's own bias. On the other hand, Constructivists (or Interpretivists) contend that it is neither possible nor desirable to have value-free judgements in social research. Both positions have strengths and weaknesses. The pragmatic paradigm is a philosophical approach that draws from both of these traditions, and uses methods from both (Burke Johnson & Onwuegbuzie, 2004). This Mixed-Method (MM) approach was selected for this study.

Mixed-Method is defined as

'the class of research where the researcher mixes or combines quantitative and qualitative research techniques, methods, approaches, concepts or language in a single study' (Burke Johnson & Onwuegbuzie, 2004, p. 17)

This method is more appropriate when the construct being studied is complex and multifaceted. As discussed in the previous chapter, the complex and elusive nature of PCK (Kind, 2009) and consequently TSPCK, lends itself to investigation using multiple methods. All research must be concerned with the issues of validity and credibility, and the range of methods and intersection of findings increases the level of validity. While triangulation potentially increases validity, the complex nature of Mixed Method studies also means that at each stage where data is interpreted across methodologies there is a further opportunity to deepen validity. The process of design, evaluation and interpretation has to be clearly outlined to ensure that the inferences drawn are valid. Wagner, Kawulich, & Garner, (2012) argue that in order for a mixed-method approach to be effective and valid the two modalities of qualitative and quantitative methodologies need to be integrated, interdependent, be given equal weight and to retain their paradigm modalities. In this study the methodologies ran parallel to each other, then data from each methodology was compared so as to interrogate and strengthen the findings (thus each maintaining their integrity).

The methodology used to answer the first research question – of the most appropriate methods for designing assessment tools for measuring teachers' CK and TSPCK in electric circuits - was a qualitative approach. The most appropriate method for measuring the CK of teachers was determined by reviewing similar assessment tools in the literature and adapting them in discussion with the reference group. This process is described in detail in Chapter 4. The TSPCK tool used the qualitative method to design open-ended questions, within the TSPCK framework of Mavhunga. The responses from the open-ended questions were used to generate the semi-closed TSPCK tool. The process of design and validation of the TSPCK assessment tool is described in chapter 5. The validity of this process stems from the rigour of the design process, and speaks to a major component of this study.

The second question of determining the level of validity for both the CK and TSPCK assessment tools used both quantitative and qualitative descriptions. The responses from the participants were analysed using descriptive statistics. The strength of the qualitative methodology is that it can be used to describe complex responses, which cannot be achieved using quantitative methods. However, the use of quantitative methods to determine statistical validity and reliability compensated for the inherent subjectivity of the qualitative methods. This study lent itself to the use of both methodologies and thus justifies the use of the MM approach.

The final question, namely determining the relationship between teachers' CK and TSPCK, was achieved by qualitative description of teacher responses in relation to the CK data, and by using statistical analysis of regression analysis and Pearson moment-product correlation. Again, the MM approach is well suited for this study.

The sections below outline the sample group and a description of the assessment tools used to collect data. A detailed description of the design and validation of the CK final

assessment tool is given in Chapter 4. A description of the design process of the TSPCK assessment tool is given in Chapter 5 and the validation of the TSPCK assessment tool is given in Chapter 6. The design processes for the CK and TSPCK assessment tools was different and warrant a more detailed description, however an overview of the processes is provided in section 3.4.

3.3. Participants

TSPCK can be viewed as specialist knowledge that only science teachers possess, so it follows that in order to measure it, the sample must be extracted from this group. In total, 16 completed final assessment tools were received. These 16 respondents were obtained after extensive canvassing. The tools were made available to 7 of my colleagues at the schools where I taught, and 6 were returned completed. They were also made available to two district clusters of science teachers. In total, 18 tools were made available to these two groups, and 2 were completed and returned. I followed up with these members personally via 3 email reminders. I posted assessment tools on the Independent Examination Board (IEB) Physics Discussion Forum, which is an online discussion group where Physical Science teachers ask questions and share resources. This platform can be accessed by registered Physical Science teachers that teach at one of the approximately 116 IEB schools throughout Southern Africa. Both assessment tools were made available with an introductory email and followed up with 2 subsequent emails. The introductory email described the study; the time required and promised a memorandum for the CK tool after the assessment tools were returned. Despite this being the widest platform, only 4 completed assessment tools were collected from this group. Six instruments were made available within the PCK research community, and 2 assessment tools were returned. The final 2 returned assessment tools were collected using word-of-mouth: friends and colleagues who had completed the tools and passed them on to other possible participants. Approximately 10 assessment tools were made available through this informal network. Completing the assessment tools requires some effort and time from the teachers, and the low response rate was one of the difficulties encountered during this project.

The final sample group comprised 16 teachers. All the members of the sample had at least one tertiary qualification within the Science field. Eleven of the 16 had a formal education qualification. Six participants had Honours degrees in a Science field, 2 had Masters degrees and 1 participant had a Doctorate in Physics. 15 of the 16 were teaching, and the remaining person was involved with educational research. Of the 15 participants in teaching, 14 were in well-resourced private schools and 1 in a state, ex-Model C, school. All had taught Physical Science for between 2 and 45 years. One participant had not taught Physical Science, but had taught electric circuits as part of the Technology curriculum. At the time of this study ten of the participants were teaching Physical Science, 2 were teaching Information Technology, 3 were teaching Mathematics and 1 was a full-time educational researcher. A summary of this demographic information is given below in Table 2. No responses were received from township schools. The tools were made available to these teachers through an informal network. The reasons for the non-return are unknown.

Table 2: A summary of the demographic information of the participants of the study

Code	Qualifications	Major Subjects	Current teaching subjects	Numbers of years teaching Physical Science at Grade 10 Level	Number of years teaching electric circuits
101	B.Sc.(Hons), PGCE	Life Science, Physics and Chemistry	Physical Science, Life Science	9	9
102	B.Sc., B.Sc. (Hons), PhD	Physics and Chemistry	Information Technology	18	18
103	B.Sc. (Ed)	Physics and Chemistry	Physical Science, Mathematics and Mathematical Literacy	2	2
104	B.Sc., B.Ed., PGCE M.Phil.	Biochemistry, Botany	Physical Science	7	7
105	B.Sc., PGCE, B.Sc.(Hons)	Zoology, Botany, Physics	Natural and Physical Science	7	7
106	B.Sc.	Chemistry, Applied Chemistry	Natural and Physical Science	20	20
107	B.Sc., B.Sc. (Hons), PGCE, M.Phil.	Physics, Mathematics, Biochemistry and Chemistry	Not teaching currently	7	7
108	B.Sc., PGCE	Life Science, Chemistry, Physics	Physical Science	10	10
109	B.Sc., PGCE	Life Science, Environmental science	Physical Science and Natural Science	27	27
110	B.Sc., B.Sc.(Hons), PGCE	Physics, Chemistry, Mathematics	Physics Science and Natural science	10	10
111	B.Sc, PGCE	Physics, Chemistry, Life Science	Physical Science	10	10
112	B.Sc., B.Sc.(Hons), PGCE	Mathematics, Physics	Mathematics 9 -12	4	4
113	B.Sc., PGCE	Chemistry, Applied Chemistry, Physics	Physical Science, Mathematics	15	15
114	B.Sc., B.Sc.(Hons)	Computer Science, Information Science	Information Technology, Technology		2
115	B.Sc., PGCE	Mathematics, Geography	Maths/maths Lit	11	11
116	B.Sc., B.Sc.(Hons)	Physics and applied Mathematics	Physics and Chemistry	45	45

In summary this sample population consisted of 6 teachers that have an undergraduate science degree and a 1 year postgraduate teaching qualification, 1 teacher has a 4-year education degree, 4 of the teachers have an Honours degree with a 1 year teaching

qualification, 2 have Masters degrees with a 1 year teaching qualification and 2 of the teachers have no teaching qualifications, 1 has a PhD and the other a B.Sc. In terms of qualification all the participants have some sort of tertiary Science training and should be able to manage the level of the content covered.

3.4. Assessment Tools

In order to answer the research questions, two assessment tools were collated and designed and drawn up - one to measure the level of content knowledge (CK) and the other to measure TSPCK levels in electric circuits. A key premise is that TSPCK can be developed only once a teacher has a good grasp of the content. The CK assessment tool was collated to measure the level of content knowledge in electric circuits, and to determine the relationship between CK and TSPCK levels. The CK assessment tool was adapted from tests found in literature. Its focus was to select items that best exposed potential misconceptions in the understanding of electric circuits. A brief description of the CK assessment tool is provided in Section 3.4.2., and a more detailed description of the design and validation process is given in Chapter 4. The TSPCK assessment tool was designed according to the categories outlined by Mavhunga (2012). The complete design and validation process is given in Chapters 5 and 6, and an overview of this assessment tool is given in Section 3.4.3. However, before the assessment tools could be collated or designed there had to be clarity as to what content would be covered in both assessment tools.

3.4.1. Determining the content coverage

Two sources were used to determine the content to be covered for both the CK and TSPCK assessment tools. The first was Loughrans' CoRe. This was one of the first ways used to represent PCK, as outlined in the Literature Review in Chapter 2. The reason this was selected was that the structure of content layout in the CoRe is focused on conceptual understanding and confronting misconceptions, which is in keeping with the premise of TSPCK. The second source was the content outlined by the CAPS (Curriculum

and Assessment Policy Statement) Grade 10 physical science document. This is the document that South African teachers use to guide the content they cover in their classroom. The content covered is summarised in Table 3.2. below. The information is organised into the main topics of complete circuits, current, voltage, energy, electric field and resistance. Where there is parity between the CoRe and the CAPS the content is summarised in the same row, but where there is content found in only one source it is placed in a different row. This is to show points of overlap and content unique to each source.

Table 3: Summary of electric circuit content used in the CK and TSPCK assessment tools, drawn from Loughran’s CoRe and the CAPS (Curriculum and Assessment Policy Statement) for grade 10 physical science

Loughran’s CoRe	CAPS (Curriculum and Assessment Policy Statement)
Complete Circuit	
A closed circuit is needed in order to transform electrical energy	
A circuit must contain a component that transforms this energy (e.g. light bulb)	
A closed circuit must contain a source of energy (e.g. battery)	
Connecting wires must connect to the battery terminals	
Current	
The movement of charged particles in one direction creates current	Indicate the direction of the current in circuit diagrams (conventional)
Charged particles can be electrons in wires or ions in solutions. Charge is measured in Coulombs	
Charge is conserved throughout the circuit	
The flow of negatively-charged particles has an equivalent flow of positively-charged particles in the opposite direction	
Current is equal to the net charge passing a point in one second	Define current, I, as the rate of flow of charge. It is measured in amperes (A), which is the same as coulombs per second. Calculate the current flowing using the equation. $I = \frac{Q}{t}$

Current is constant through the circuit	
Current will flow through the path of least resistance (short-circuit)	
	Draw a diagram to show how to correctly connect an ammeter to measure the current through a given circuit element
Voltage	
The battery always provides the same amount of potential energy	
	Know that the voltage measured across the terminals of a battery when no current is flowing through the battery is called the emf (electromotor force)
	Know that the voltage measured across the terminals of a battery when current is flowing through the battery is called terminal potential difference (terminal pd (potential difference)).
	Know that emf and pd are measured in volts (V)
Volts is defined as Joules per Coulomb (J.C ⁻¹)	Define potential difference in terms of work done and charge. $V = W/Q$ Do calculations using $V = W/Q$
	Draw a diagram to show how to correctly connect a voltmeter to measure the voltage across a given circuit element
Energy	
Energy is transferred in a circuit	
Total energy is conserved	
Amount of energy delivered by battery is not the total transformed; some lost due to heat	Explain why a battery in a circuit eventually goes flat by referring to the energy transformations that take place in the battery and the resistors in a circuit
The rate at which energy is dissipated is equal to the power	
Electric Field	
Battery creates field, along which charged particles move	
The larger the 'potential difference' the larger the fields, and the greater the flow of charge (current)	
Resistance	
	Define resistance: explain that resistance is the opposition to the flow of electric current Define the unit of resistance; one ohm (Ω) is one volt per ampere.

	<p>Give a microscopic description of resistance in terms of electrons moving through a conductor colliding with the particles of which the conductor (metal) is made and transferring kinetic energy.</p> <p>State and explain factors that affect the resistance of a substance</p>
If there is one resistance in the circuit, then potential difference across the resistor is equal to that of the battery	
	Know that current is constant through each resistor in series circuit
If a second resistor is placed in a circuit in series, then the potential difference across both the resistors is equal to the potential difference across the battery	Know that series circuits are called voltage dividers because the total potential difference is equal to the sum of the potential differences across all the individual components.
	<p>Calculate the equivalent (total) resistance of resistors connected in series using:</p> $R_T = R_1 + R_2 + R_3$
The higher the resistance the higher the potential difference across the resistor	
The relationship between resistance and current is inversely proportional	
Resistance can be defined as V/I (Ohms Law)	
Parallel Connections	
Parallel connections are those where conductors divide the current path	
Batteries connected in parallel deliver a combined voltage equal to the voltage of the largest individual cell	
Resistors connected in parallel will divide the current through them in ratio to their resistance. (The largest resistor will have the smallest current flowing through that branch)	Know that a parallel circuit is called a current divider because the total current in the circuit is equal to the sum of the branch currents
<p>Resistors connected in parallel decreases the total resistance of the circuit.</p> $R_p = \frac{\text{product}}{\text{sum}} = \frac{R_1 R_2}{R_1 + R_2}$	<p>Know that for two resistors connected in parallel, the total resistance can be calculated using:</p> $\frac{1}{R_T} = \frac{1}{R_1} + \frac{1}{R_2} + \frac{1}{R_3}$ <p>Calculate the equivalent (total) resistance of resistors connected in parallel using:</p> $R_p = \frac{\text{product}}{\text{sum}} = \frac{R_1 R_2}{R_1 + R_2}$
The voltage across a parallel connection and the voltages across the individual resistors in parallel remain constant	Know that voltage is constant across resistors connected in parallel

The reason for selecting both sources as content guidelines is that the CAPS guidelines are still relatively new, and sections not specifically included in the CAPS document, but included in the CoRe, would still potentially be taught in a grade 10 classrooms. The most striking example of this is the explanation of Ohm's law and the use of $R = V/I$, which is not directly mentioned in the CAPS document. On the other hand, the CoRe does not include drawing circuits and the use of instruments to measure current and voltage, which is seen as an important skill at the grade 10 level. The CAPS also places emphasis on the correct use of terminology, which is regarded as an important area of focus, as the use of physics terminology in everyday language, e.g., "charging my phone", can readily lead to misconceptions. Much of the content stated in the CoRe is implicit in the CAPS but it is not directly stated in the CAPS because it is covered in earlier grades but this does not diminish its importance, for example in the CoRe the content descriptor of '*Current is constant through the circuit*' is not directly stated in the Grade 10 CAPS but it is found in the Grade 8 and 9 requirements. The use of both the CoRe and CAPS content statement allows for comprehensive content coverage.

All the items in both the CK and TSPCK assessment tools were selected or designed within the confines of the above content descriptions. A short description of the CK and TSPCK assessment tools is given in the sub-sections 3.4.2 and 3.4.3. A more detailed description of the selection of the items for the CK assessment tool is given in Chapter 4 and the design process of the TSPCK assessment tool is given in Chapter 6. A broad overview of the format of the two assessment tools is given in the following sub-sections 3.4.2 and 3.4.3.

3.4.2. A brief description of the structure of the final CK assessment tool

The final CK assessment tool consisted of 20 multiple choice items each with 5 possible options. The correct option was assigned a value of 1, once marked; the final score is calculated as a percentage. The items for the content tool were drawn from validated tests in the literature, namely the 'Determining and Interpreting Resistive Circuit Concepts Test (DIRECT) (Engelhardt & Beichner, 2004) and Pesman, et al 'Three Tier

Test' (Pesman & Eryilmaz, 2010). Both these tests have been validated across large samples, which adds to the validity of the content tool. An initial test with 30 items was piloted and this was reduced to 20 items to make testing more manageable.

In addition to the question, the teachers are asked to rate how confident they felt about their answer. Four confidence levels are provided for the teacher to select, namely, (i) blind guess, (ii) a bit unsure, (iii) confident and (iv) completely sure. The confidence ratings were assigned scores of 1 to 4, and the final confidence level calculated as a percentage. The purpose of the confidence rating is to determine the type of content knowledge a teacher possesses; for example, a teacher selecting the correct answer, might state that she is had guessed it: she does not necessarily possess the required content knowledge. Conversely, a teacher might state that she is completely sure of her answer, but select the incorrect option: this is potentially a sign of a misconception which could be transferred to her students.

The final CK assessment tool is attached in Appendix C and the memorandum in Appendix D.

3.4.3. A brief description of the final TSPCK assessment tool

The final TSPCK assessment tool was developed after a rigorous process of pre-piloting, piloting and finally adaption which is described in detail in Chapter 5. What follows here is a brief outline of the structure of the final TSPCK assessment tool. The completed assessment tool is attached in Appendix A.

The second assessment tool designed was the TSPCK instrument. The format is drawn from the work done by Mavhunga and Rollnick (2013), using the following categories

- (i) learner prior knowledge and misconceptions

- (ii) curriculum saliency
- (iii) 'what is difficult to teach'
- (iv) representations and analogies and
- (v) conceptual teaching strategies.

Category A – Student prior knowledge and misconceptions.

Two multiple-choice items with 3 possible responses are presented which a teacher could give to correct an incorrect answer by a student. A final option of writing her own response is added in case the teacher is not satisfied with any of the options provided. All the options are basically correct, and the teacher is asked to give reasons for her selection. The reason is the answer that is categorised.

Category B – Curricular Saliency

There are 3 items in this category, which are semi-open. The first item contains a list of 14 topic statements relating to electric circuits that include main and subordinate ideas. The teacher is asked to select the main ideas and the sequence she would teach them, explaining her rationale. The second item is drawing a concept map, and the final item is open-ended, where the teacher is asked why it is important to teach electric circuits at all.

Category C – What is difficult to teach

There are 2 items in this category. The first item contains a table of relatively difficult concepts and the teacher is asked to select 3 that are particularly difficult to convey to students and to give reasons for her selection. The option is also given for the teacher to mention his/her own concepts not included in the table. In the second item the teacher is asked to identify terminology of electric circuits considered to be problematic for students – again, giving reasons.

Category D – Representations and analogies

There is 1 semi-open item in this category. Three representations of current flow in parallel circuits are given and the teacher is asked why she like or dislikes each, and how she would use the one she considers the best in her practice.

Category E – Conceptual teaching strategies.

There are 3 open-ended items in this category, using authentic verbatim student answers to a class exercise, as the reference point for the TSPCK questions. The teacher is asked to identify which concepts the student has in place, what concepts are missing, and which strategies she would employ to rectify the gaps.

The responses were collected and analysed using category descriptions. This step entailed effectively, accurately and consistently categorising the responses in terms of TSPCK. To this end great care had to be taken in the design of the assessment rubric.

3.4.4. Rubric used to analyse responses

The aim of this project is to design an assessment tool that is a valid assessment of TSPCK so it follows that the criteria used rank the TSPCK responses were a critical component of the design process. The rubric needs to clearly discriminate between different levels of response from teachers. It is in the designing of the descriptors for the rubric that the challenge of defining and delineating of what constitutes 'good' TSPCK and what is 'bad' TSPCK, is confronted. The rubric was designed using 4 levels of criteria, namely; 'limited', 'developing', 'basic' and 'exemplary'. Criteria were written for each of the 5 TSPCK categories. The final assessment rubric is attached in Appendix B.

The development of the assessment rubric formed part of the qualitative analysis. While rubrics to assess teachers TSPCK in other science topics exist for example in chemical equilibrium and electrochemistry, it was not expected that these could be used without adaption. The underlying premise of TSPCK is that there is a unique set of strategies and thinking within a specific topic hence the criteria also have some level topic specificity within a generalised structure. The discussion to reach a clear description of criteria is first involves qualitatively analysing the type of responses and debating and articulating why one response is 'better' than another. The final scores are not the only outcomes of the research but the process of understanding and articulating the type and level of

reasoning is also an important outcome of the study. The care taken with the design of the assessment rubric is an important component of establishing validity and reliability of the TSPCK assessment tool. The goal is to have 100% agreement between different assessors using the same rubric. In this study an agreement rating of 83% was achieved which is good level of agreement and did indicate an acceptable level of reliability with the scoring of the responses.

3.5. Analysis and validation of assessment tools

The purpose of the research is to design and validate assessment tools that measure CK and TSPCK; hence discussion of validity speaks to the heart of the project. In broad terms validity can be seen as the extent to which a measurement, or 'score', measures what it was intended to measure. In this study the terms validity and reliability are used to determine the quality of assessment tools designed. The designed tools will be useful only if they measure what they are intended to measure and if the data obtained from them is meaningful (Creswell, 2012). Reliability is closely related to validity and refers to the extent that consistency of results is obtained – would similar results be obtained with another, comparable sample population (Neuman, 2000)?

Ensuring validity and reliability is an ongoing process during the construction of the assessment tools and in the final analysis of the collected data.

3.5.1. Validity during the construction of the Content and TSPCK Tools

The assessment tool that is the subject of this work is a new tool to measure topic-specific pedagogical content knowledge of electric circuits; and its suitability for use beyond this study depends on its being deemed valid and reliable. The process of generating scores for the tools was very important, as this numerical data was used to determine statistical validity.

A narrower focus - the principle of construct validity - was used as the basis to argue for the validity of these tools. Construct validity requires that there be an interpretation of the conceptual framework being measured, together with empirical evidence that the 'score' does measure the intended construct. Messick's definition of construct validity is

The overall evaluative judgement of the degree to which empirical evidence and theoretical rationales support the adequacy and appropriateness of interpretations and actions on the basis of test scores or other modes of assessment (Messick, 1995).

The two key components to this definition are (i) the theoretical or interpretive argument and (ii) the empirical evidence for validity.

Validity and, in particular, construct validity was ensured by detailed consultation with the reference team - which comprised a physics specialist, an assessment specialist, an educational researcher and practising teachers - during the construction of both the pilot and final tools. The process of piloting the tools increased the validity because feedback from the participants could be gathered with regard to phrasing or items that were ambiguous. This feedback helps eliminate extraneous factors that draw the attention away from the construct being tested. The use of the model of Mavhunga & Rollnick, (2012), that had been tested and validated with other topics, (Ndlovu, 2014) was the starting point of validity.

3.5.2. Quantitative validation

For the quantitative aspect of this project the raw scores of both the Content and TSPCK tools were subjected to a statistical analysis using the Rasch model, using Winsteps software, version 3.81.0. The Rasch software converts the raw data into a linear scale. This scale is termed the 'normalized' Rasch, and allows a hierarchical ranking of a person's ability according to item difficulty (Bond & Fox, 2001). The reason Rasch analysis was selected is that it measures the extent to which each single construct is being measured. In the case of this study it is important to know whether the construct

of content knowledge in the CK assessment tool, and the level of TSPCK in the second is what is actually being measured.

Based on Item Response Theory, the Rasch statistical model has several strengths that make it appropriate for this study. The first is that it takes raw data and places it in a linear scale, which makes ranking of responses possible (Boone & Scantlebury, 2006). This information is particularly useful for this project as the relative strength or weakness of teacher responses to different classroom scenarios is the key question. The second is that, in contrast to other statistical models which measure average numerical data and which background the range of responses, Rasch focuses on the item and person score, thus measuring the validity and reliability of a single parameter. As this study needs to establish whether the assessment tool is able to measure the single construct of TSPCK, the focus on a single parameter is appropriate. Another benefit of the Rasch model is that it can be used on “relatively small sample sizes without violating its fundamental assumptions” (Aziz 2010), which is valuable for a study that worked with responses from only 16 participants.

The Rasch software generates a data matrix based on item difficulty and person ability. The higher the level of validity of the data, the more coherently these two constructs work together. In other words, more difficult items have fewer correct answers and easier items have the most correct answers and ‘persons’ getting the more difficult items correct are also getting the easier items correct. In order to measure this coherence, two indices of fit, namely, *Infit* and *Outfit*, are calculated. Linacre (2012) describes the fit statistic as the difference between a person’s observed score and the predicted score, statistically calculated, based on the person’s ability. The *Infit* indices are a measure of the discrepancies between a person’s expected performance and observed performance. The *Outfit* index reflects items that are quite distant from a person’s ability level and therefore not expected to be achieved (Boone & Rogan, 2005, p. 34). A range between -2 and +2 is seen as an empirical argument for validity (Bond &

Fox, 2001). The statistical data for the CK assessment tool is presented in Chapter 4 and the data for TSPCK is presented in Chapter 5

An additional quantitative analysis was applied to determine the statistical correlation between the CK and TSPCK assessment tool results. For this I used regression analysis and Pearson moment-product correlation. This step was undertaken to answer the research question of determining the relationship between CK and TSPCK, and to test the assumption that good content knowledge is a prerequisite for TSPCK.

The quantitative processes were not used in isolation, but in conjunction with qualitative methodologies.

3.5.3. Qualitative analysis

Besides the quantitative analysis, the responses to the TSPCK assessment tool were analysed qualitatively, more in line with the interpretivist research tradition. Using this methodology entails looking for meaning in the responses and relating it to the construct being tested (Neuman, 2000). This type of analysis occurred at two points in this project, firstly in the design of the TSPCK rubric, and then in the final analysis and explanation of findings.

The responses were scrutinised for evidence of reasoning with regards to teaching practise. This analysis of the responses occurred concurrently with the design of the rubric. While developing the criteria for the rubric the responses and evidence of different types of reasoning were sought. The SOLO taxonomy was a useful tool to help discriminate between different orders of reasoning. SOLO taxonomy uses the number and type of connections between ideas as an indicator of reasoning (Biggs, 1982). The nature of the topic of electric circuits allowed for multiple links between ideas. In this qualitative analysis the primary question was to determine if it is possible to see teacher

TSPCK in their written responses. Examples of how this was observed and recorded are given in Chapter 6.

An additional qualitative analysis was to look for evidence in both the CK and TSPCK assessment for the type of knowledge transformation a teacher requires for demonstrating TSPCK in electric circuits. The results of the CK assessment tool were compared with the TSPCK scores to see if relationships existed between these two data sets. For example, where evidence from the CK assessment tool indicated that a teacher was working with the misconception herself, the TSPCK assessment tool responses were analysed for possible evidence of the impact in her teaching. Evidence for the converse was also sought in order to answer the question of how the responses in the TSPCK assessment tool differ between a teacher with good content knowledge and one without. Examples of this analysis are given in Chapter 6 in response to the final research question.

3.6. Ethical issues

The participants who completed the two tools were invited to participate, and gave their informed consent. Before I was able to proceed I had to comply with the ethical standards of the University's Human Ethics Research Committee (Non-medical). The Ethics Clearance letter is attached in Appendix G. Anonymity of the participants was maintained throughout, with each participant being assigned a numerical code and their signed consent forms and biographical information kept separate from the completed CK and TSPCK assessment tools. The information letter and the participant declaration letters are attached in Appendix E). The participants were not harmed by their participation in the study. To thank the respondents for their participation, I sent them the memorandum for the CK assessment tool, the 10 questions taken out of the pilot and a summary of the common misconceptions in electric circuits. The CK assessment tool is potentially a useful teaching tool because the questions are conceptual in nature, and are designed to uncover misconceptions. This resource was made available to the

teachers involved to use in their practice if they wished. (This resource is included in Appendix F)

The main beneficiary of this study was myself, as the entire study has been an enormous learning experience, and will hopefully result in a Masters qualification. Engaging with this topic has allowed me to critically reflect on my own teaching practice and to become more aware of the decisions I make in the classroom. A secondary beneficiary is the School of Education at the University of the Witwatersrand, which will be able to use the generated tools in their teacher preparation programmes. The project will also be made available to the wider science and education community through the e-library system, and could potentially benefit this large community.

3.7. Conclusion

An outline of the methodological approaches employed to generate CK and TSPCK assessment tools has been presented, together with the precautions taken to ensure validity throughout the process. Determining validity is central to answering the research questions presented in the first chapter. The following three chapters describe the design and validation processes for both assessment tools in detail.

Chapter 4 - The process of developing and the validation of the Content Knowledge (CK) assessment tool

In this chapter I outline the process of developing the Content Knowledge (CK) assessment tool for piloting, the adaptations after piloting and the development of the final CK assessment tool. A summary of the scores from the CK assessment tool is given. The second part of the chapter is devoted to measuring the validity of the CK assessment tool.

4.1. Introduction

Two assessment tools were designed and validated for this project, the Content Knowledge (CK) and the TSPCK assessment tools. This chapter focuses on the design and validation of the first, and the next two chapters on the development and validation of the second. The two assessment tools are equally important, and were subjected to similar design and validation procedures. A key principle of TSPCK is that teachers cannot demonstrate good TSPCK without strong prior content knowledge. My third research question concerns the relationship between content knowledge and TSPCK, so it was necessary to design two tools covering the same content, but with different emphasis. In the case of the CK tool the focus was on determining the level of conceptual knowledge of the teacher regarding electric circuits; the TSPCK assessment tool was designed to collect evidence of how a teacher appropriates this knowledge to make it accessible to students. The two types of knowledge are interrelated and equally significant.

In the Mavhunga and Rollnick project the development process for items followed the 'rational method' outlined by Oosterveld & Vorst (1996), which emphasises empirical data and the judgments of experts as particularly important. In this project I followed a similar process. The chronological process followed is summarised in the flow diagram below (Figure 9.):

Step 1: the selection of content to be covered using CAPS and Loughrans CoRe's

Step 2: the selection of assessment items from literature, Engelhardt & Beichner DIRECT test and Pesman & Eryilmaz Three-Tier Test,

Step 3: piloting the selected items;

Step 4: reducing items from 30 to 20

Step 5: distribution of the assessment tool to a large sample of science teachers, this process was repeated twice

Step 6: the scoring of both the assessment tool

Step 7: validation, using quantitative and qualitative methods

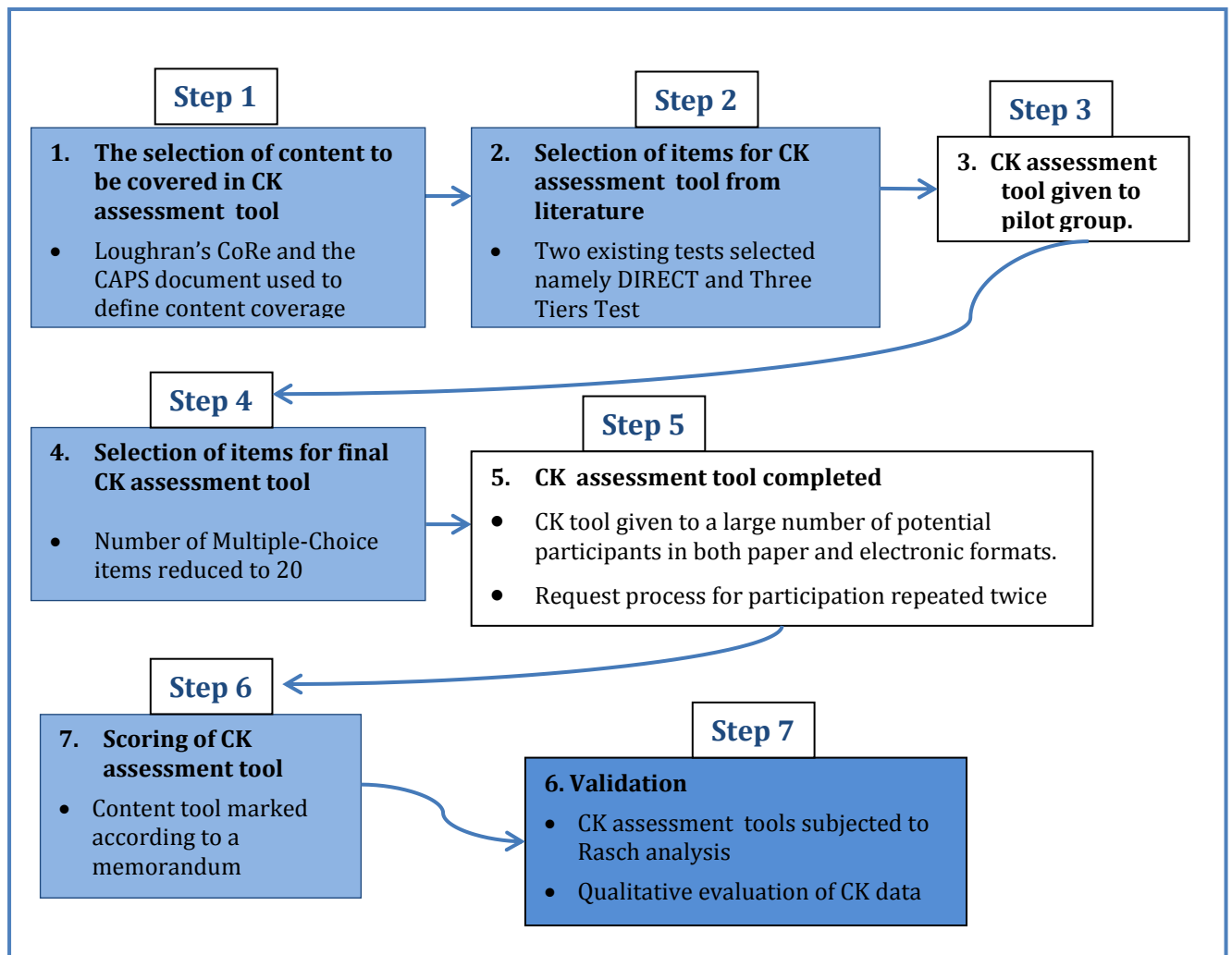

Figure 9: A flow diagram outlining the process of development and analysis of items for the CK assessment tool

4.2. Developing the CK assessment tool

4.2.1. Step 1: Selecting the content to be covered in the CK assessment tool

Before the CK assessment tool could be designed the content to be covered needed to be defined. Two sources were used for this, namely the Grade 10 CAPS document and Loughran’s CoRe. A detailed list of the content topics covered is given in summary of this content is given in sub-section 3.4.1. The topic descriptors from both documents were classified under wider themes and then a key idea or principle from each topic was selected as a focus. A summary of the major content areas covered in the CK assessment tool and a description of the key idea within each content area is given in Table 4 below.

Table 4: A summary of the content selected for the CK assessment tool

Content area	Key Idea/s
Complete Circuit	A closed circuit is required for energy transformation to occur.
Current	Current is the rate flow of charge and is conserved throughout a circuit.
Voltage	This is a measure of energy transfer per Coulomb of charge. When no current is flowing through a circuit there is a measurable voltage across the terminals, called <i>emf</i> .
Electric Field	The battery generates an electric field along which charges are able to move. The larger the field the larger the current.
Resistance	Resistance is the opposition to charge. A resistor is the site of energy transfer and transformation. The addition of a resistor affects the current throughout the circuit.
Parallel Connections	Resistors connected in parallel have the effect of dropping the overall resistance of the circuit. At the point of the parallel resistor connection current is divided in proportion to each resistor. Voltage is constant across resistors connected in parallel

In the selection of the content there was a focus on extracting the key conceptual ideas that are critical for understanding electric circuits. There was a conscience decision to move away from algorithmic descriptions to more conceptual phrasing. The key ideas were also selected based on the reference teams' experience of the areas students find difficult to understand. Concepts were also selected if they were essential for understanding for the material covered subsequent grades.

4.2.2. Step 2: Selection of items for CK assessment tool

As part of the initial phase of development, the science literature was reviewed for pre-existing diagnostic tests that potentially could be used or adapted for the CK assessment tool. Three existing tests were found in the literature and were evaluated for suitability for use in the CK assessment tool. These tests were the (i) Engelhardt & Beichner, (2004): Determining and Interpreting Resistive Electric Circuit Test (DIRECT) (ii) Pesman & Eryilmaz, (2010): Three-Tier Test, and (iii) the 'Capacitor-Aided System for Teaching and Learning Electricity' (CASTLE), Wainwright (2004).

Pesman and Eryilmaz (2010) produced a test to measure competence in electric circuits, validating it with 124 grade 9 students. Engelhardt (2004) completed an extensive study with 1135 high school students and 681 first-year university students evaluating their reasoning with regard to electric circuits, and developed the Determining and Interpreting Resistive Electric Circuit Test (DIRECT test). Wainwright (2004) developed the "Capacitor-Aided System for Teaching and Learning Electricity' (CASTLE), as diagnostic test for electric circuits as part a program designed for high school students wishing to enter engineering courses.

All three of the measuring tools were designed with the purpose of uncovering common misconceptions regarding electricity circuits. They were designed for use by students, and represent a minimum level of content knowledge. All of them draw on prevalent misconceptions, so the questions designed were those that students were most likely to

get wrong. This specificity of design means that they are relatively short, yet yield specific information about misconceptions and the level of conceptual knowledge.

In order to select which one of the above tests, or parts within them, best suited my purpose; the three tests were compared based on:

- (i) the number and type of misconceptions, as discussed in the literature review Chapter 2, sub-section 2.6.1
- (ii) their alignment with the both South African CAPS document and Loughrans' CoRe, in particular referring to the 'Big Ideas'
- (iii) their readability and ease of use and
- (iv) the level of validity established in literature.

The CASTLE test consists of 15 multiple-choice questions with a 5-level confidence scale. The purpose of the study was to identify misconceptions and the required strategies to remediate them. The DIRECT test consists of 29 multiple-choice items and includes a third part to each question asking the participant to give their level of confidence. The Three-tier test consists of 12 items of 3 parts each. The first part deals with content (multiple-choice), the second with reasons for selections (also multiple-choice, also providing for the participants to give their own reason) and the third part was a description of the confidence about the answer given.

There is a broad consensus of content required for a basic understanding of electric circuits, so all three these tests covered similar content. The content in all three the tests covered topics in either Loughran's CoRe or the CAPS document. With content coverage not being a good discriminator between the tests, the number and type of misconceptions each test addressed became important selection criteria. Table 5 below shows a comparison of the three tools against the misconceptions, outlined in the literature review.

Table 5: Table showing the comparison of the 3 selected tests against misconceptions within electric circuits.

Misconceptions in electric circuits summary description	Pesman et al (Three-Tier)	Wainwright CASTLE	Engelhardt et al (DIRECT)
‘attenuation model’ - Current is used up	✓	✓	✓
‘power supply as constant current source’ - Batteries deliver a fixed amount of current regardless of cell components	✓	✓	✓
‘sink model’ - A single connection between the battery and component is required	✓		
‘shared current model’ - Current is shared equally with all circuit components	✓		✓
‘sequential model’ - A change in a circuit affects only those components after the change.	✓	✓	✓
‘clashing model’ - Current from the positive and negative terminals meet at the circuit component	✓	✓	
‘empirical rule model’ - The further away a bulb is away from the battery the dimmer it will be	✓		
‘short circuit’ - Wires with no circuit components can be ignored when analysing a circuit	✓		✓
‘parallel circuit misconceptions’ - Increase of resistors in parallel increases the overall resistance	✓	✓	✓
‘local reasoning’ - Circuit not viewed as a system. Any change affects only the component being changed, and not the whole circuit	✓	✓	✓
‘current as water flow’ - Current strongest in a straight path. A bend in the wire decreases current strength	✓		
‘battery origin’ - Battery a source of charges that are pumped out rather than being recycled		✓	✓
‘interchangeability of terms’ - Voltage, current, power charges, energy, used as one property			✓
TOTAL	11	7	9

All three tests cover the main misconceptions, with the Three-Tier Test and DIRECT covering the misconceptions more fully. In addition to helping the selection process of items for the CK assessment tool, the comparison also revealed which misconceptions were included in all three tests, and these misconceptions were then regarded as more important or more prevalent. This information guided the selection of the items for the

CK assessment tool, as well as for the design of the TSPCK tool discussed in the next chapter. The misconceptions included in all three tests are

- (i) **'attenuation model'** - Current is used up
- (ii) **'local reasoning'** - Circuit not viewed as a system. Any change affects only the component being changed and not the whole circuit
- (iii) **'parallel circuit misconceptions'** - Increase of resistors in parallel increases the overall resistance
- (iv) **'sequential model'** - A change in a circuit affects only those components after the change.

The main purpose of the comparison, however, was to determine which items or test was best suited for the pilot CK assessment tool. The Wainwright CASTLE tool was excluded early in the selection process because information about the number of students who wrote the test and their performance was not included in the literature, which limits its validity. However, Wainwright's analysis of questions in relation to misconceptions and the use of confidence rating were useful in analysing my CK assessment tool. The remaining two tools had similar misconception coverage, but the language and structure of the DIRECT assessment tool was considered to be much simpler, more accessible and less time consuming than the Three-Tier Test. The inclusion of the correct use of terminology in the DIRECT assessment was also a favourable point. The DIRECT assessment tool was validated with a larger sample than the Three-Tier Test.

Considering all these factors the 29 items from the DIRECT assessment tool were used verbatim for the pilot CK assessment tool. A question on parallel circuits from the Three-Tier Test was also included slightly altered, because it was conceptually challenging. Figure 4.2. shows the original item from the Peşman & Eryilmaz (2010) Three-Tier Test and how it was adapted for the pilot CK assessment tool.

Original

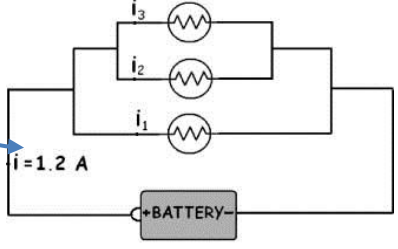

Figure 2

2.1. The current at the main branch is 1.2A. What is the magnitudes of currents i_1 , i_2 , and i_3 ?

a) 0.6/0.3/0.3 b) 0.4/0.4/0.4

2.2. Which one of the followings is the reason of your answer to the previous question?

a) After the current is divided evenly on the first junction, it is again divided evenly on the second junction.
 b) Because the identical bulbs are in parallel, currents with the same magnitude pass through the bulbs.
 c)

2.3. Are you sure about your answers given to the previous two questions? a) Sure .b) Not sure

Changes made for the CK assessment tool

20. The current in the main branch is 1.2 A. What are the magnitudes of currents i_1 , i_2 , and i_3 ?

A. 0.6/0.3/0.3
 B. 0.4/0.4/0.4

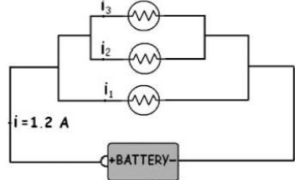

Excluded part

Figure 10: Extract showing the original item in the Three-Tier Test (Pesman et al) tool and the changes made for the CK assessment tool.

4.2.3. Step 3: Evaluation and piloting of items for the content tool

The pilot draft CK assessment tool was piloted with a reference team consisting of a Physics specialist and 2 senior science teachers. In discussion with the referrence team, early on in the development process, it was felt that the CK assessment tools were too long, and it was decided to reduce the number of items in the final CK assessment tool from 30 to 20.

4.2.4. Step 4: Selection of items for final CK assessment tool

The initial process of selecting the items for the pilot CK assessment tool was based primarily on misconceptions addressed, but the decisions on which items to eliminate were based on the content coverage. The selected content was drawn from Loughran's CoRe (2006) with particular reference to the 'Big Ideas' and the CAPS document, outlined in Chapter 3. The criteria for selection in were:

- (i) items that covered multiple topics were given preference
- (ii) items that were the only question that related to a particular content section
- (iii) items were eliminated if there were other questions that covered the content areas
- (iv) items that required knowledge of the internal construction of a light bulb were excluded
- (v) items were eliminated where there was the potential for confusing due to phrasing or diagrams

Table 6 below shows the selection of items, with the content used for selection, the number of questions that covered that topic and the items as they are numbered in the Content Tool. Table 6 outlines the content covered and which questions address that topic. An additional column of the misconceptions that each question addresses was included; this was done to ensure that a misconception was not excluded unintentionally by the reduction process. The questions excluded and the reasons for elimination are also included in Table 6.

Table 6: Showing the content summary covered by the pilot CK assessment tool and the items retained for the final tool, together with reasons for exclusion, and the related misconception of each of the retained questions.

Question number in Pilot CK assessment tool	Broad Topic Name							Reason/s for exclusion	Number in final CK assessment Tool	Potential Misconception covered
	Complete Circuit	Current	Voltage	Electric Field	Energy	Resistance	Parallel Connections			
1	✓	✓			✓			Y	1	Attenuation model
2					✓	✓		Y	2	Local Reasoning
3			✓	✓				Y	3	Local Reasoning and battery origin
4						✓	✓	Y	5	Parallel circuit misconceptions and short circuit
5						✓	✓	Y	4	Parallel circuit misconceptions
6			✓			✓		Y	6	Local reasoning and sequential model
7			✓	✓		✓		N	Repetitive: content covered by other questions	
8		✓						Y	7	Attenuation
9	✓							N	Requires knowledge of internal structure of a light bulb	
10		✓			✓	✓	✓	Y	8	Short circuit
11				✓				Y	9	Battery origin
12					✓		✓	Y	10	Parallel circuit misconceptions and interchangeability of terms
13	✓						✓	Y	12	Parallel circuit misconceptions
14	✓					✓	✓	Y	11	Local reasoning and Parallel circuit misconceptions
15			✓			✓		Y	13	Local reasoning and Parallel circuit misconceptions
16					✓	✓	✓	Y	14	Parallel circuit misconceptions
17						✓	✓	Y	15	Sequential model
18	✓							N	Too narrow content focus, diagram confusing	
19		✓						N	Too narrow content focus, content covered by other questions	
20			✓					N	Too narrow content focus.	
21			✓			✓		Y	16	Sequential model and local

Question number in Pilot CK assessment tool	Broad Topic Name								Reason/s for exclusion	Number in final CK assessment Tool	Potential Misconception covered
	Complete Circuit	Current	Voltage	Electric Field	Energy	Resistance	Parallel Connections	Selected (yes/no)			
											reasoning
22	✓							N	Similar to question 13		
23	✓							Y		17	Inter-changeability of terms
24			✓					Y		18	Inter-changeability of terms and battery origin
25			✓		✓	✓		N	Content covered by other questions		
26					✓	✓		N	Content covered by other questions		
27	✓							N	Content covered by other questions		
28	✓		✓					Y		19	Battery origin
29							✓	N	Too narrow content focus, content covered by other questions		
30						✓	✓	Y		20	Parallel circuit misconceptions
Total	5	3	5	2	5	13	9			20	

From this table it can be seen that the content was well covered, together with areas where there could be misconceptions. The topic of resistance might seem to be unduly repeated, but this is because resistance is often asked in conjunction with other topics such as current and voltage, so there is considerable overlap.

The final content tool consists of 20 multiple-choice items. In addition, a 4-level confidence rating scale was included. The 4 levels of the confidence scale are 1- '*blind guess*', 2- '*a bit unsure*', 3- '*confident*' and 4 - '*completely sure*'. The confidence scale adds another possible level of analysis. An incorrect answer with a high confidence level indicates that the teacher is operating with a misconception herself. Once observed, it is possible to see the impact this has on her answers in the TSPCK assessment tool,

relating to that particular misconception. An example of the final CK assessment tool is attached, together with the memorandum, in Appendix C and D.

As an informal check of the accessibility and time requirements of the tool I gave it to my Grade 10 students as a class test. The majority finished the test in 40 minutes, which I took as a good indication of the manageability of the tool for experienced science teachers.

4.2.5. Step 5: Distribution of CK assessment tool

At this point the Content Tool was finalised and ready to be out sent out to the sample group. The CK assessment tool was sent out together with the TSPCK assessment tool. Both tools were made available to my colleagues, members of the research group, the IEB online discussion forum, two district science clusters and informally to friends and via word-of-mouth. The procedure for making the CK assessment tool available is given in Chapter 3 sub-section 3.3. The response level for both assessment tools was low and this limitation will be discussed in Chapter 7.

Steps 6 and 7 of scoring and validation of the CK assessment tool are discussed in the next sub-sections.

4.3. Scoring and validation of the CK assessment tool

The scoring and validation of the CK assessment tool were critical steps in answering the research questions.

4.3.3. Step 6: Scoring the CK assessment tool

The CK assessment tool was scored with a memorandum, and a percentage score calculated. A confidence percentage was also calculated. The results of the scoring are given in Table 7 below. The confidence level is also given as a numerical value. Some of the respondents did not complete the confidence level rating, so it was only possible to

score whether their answers were correct or incorrect. The final scores and confidence are presented in Table 7. The potential sites of misconceptions and content gaps are also included in this table. A misconception was recorded when a teacher responded they felt confident about their answer but they got that question incorrect. A knowledge gap was recorded when the teacher recorded a low confidence level and got the question incorrect. There is a difference between a misconception and a knowledge gap, in this case. The teacher who holds the misconception believes they are working with a correct understanding, when they have an incomplete or incorrect conceptual understanding. A teacher with a knowledge gap recognises that they are missing content and understanding.

The following colour codes are used:

Red: the participant has an incorrect answer, but is confident about the answer. This misconception could affect how he/she answers the TSPCK assessment tool.

Blue: the answer is incorrect and the confidence level is low. This was taken as a lack of content knowledge. This also could affect how the teacher answers the TSPCK assessment tool.

Pink: A teacher might answer correctly, but with a low confidence level. This also indicates a lack of knowledge or uncertainty about the content and the correct answer might be due to a guess. These questions have been highlighted in pink.

White: The answer is correct and the teacher has a high level of confidence or where no confidence level was given by the respondent.

Table 7: Showing scoring results of CK assessment tool and confidence rating

Key

	Site of potential misconception
	Site of lack of content knowledge
	Possible site of lack content knowledge; correct answer due to a guess
	Correct answer and high confidence level
CR	Confidence Rating: 1 - Blind guess 2 - A bit unsure 3 - Confident 4 - Completely sure

✓ = correct answer
X = incorrect answer

Question number	Participant Number																# of incorrect responses	# of potential misconceptions
	101	102	103	104	105	106	107	108	109	110	111	112	113	114	115	116		
1	✓	✓	X	✓	✓	✓	✓	✓	✓	✓	✓	✓	X	X	X	✓	4	2
CR	4	4	3	4	3	3	3	3	3	3	4		3	2				
2	X	X	✓	✓	✓	✓	✓	✓	✓	✓	✓	✓	X	✓	X	✓	3	3
CR	4	4	3	4	3	3	4	3	4	4	4		4	2				
3	✓	✓	✓	✓	✓	✓	✓	✓	✓	✓	✓	✓	✓	✓	X	✓	1	0
CR	4	4	3	4	3	3	4	3	4	4	4		3	2				
4	✓	✓	✓	✓	✓	✓	✓	✓	✓	✓	✓	✓	✓	✓	✓	✓	0	0
CR	4	4	3	4	4	3	4	3	4	4	4		4	3				
5	✓	✓	✓	X	X	✓	✓	✓	✓	✓	X	✓	✓	X	X	✓	4	4
CR	4	4	3	4	4		4	3	4	4	3		3	4				
6	X	✓	✓	✓	✓	✓	✓	✓	✓	✓	✓	✓	✓	X	✓	✓	2	0
CR	2	4	3	4	4	3	4	4	4	4	4		4	2				
7	✓	✓	✓	✓	✓	✓	✓	✓	✓	✓	✓	✓	✓	✓	✓	✓	0	0
CR	4	4	3	4	4	3	4	3	4	4	4		3	2				
8	✓	✓	✓	✓	✓	✓	X	✓	✓	✓	✓	✓	✓	X	✓	✓	2	1
CR	4	3	2	3	2	3	4	3	4	4	4		2	2				
9	X	X	✓	✓	✓	✓	X	✓	✓	X	✓	✓	✓	X	✓	✓	5	2
CR	4	4	2	3	3	3	2	3	3	2	3		3	2				
10	X	X	✓	✓	X	✓	✓	✓	✓	✓	✓	✓	✓	X	✓	✓	4	4
CR	4	4	3	3	3	3	4	3	4	4	4		4	3				
11	✓	✓	✓	✓	✓	✓	✓	✓	✓	✓	✓	✓	✓	X	✓	✓	1	1
CR	4	4	3	4	4	3	4	4	4	4	2		3	3				
12	✓	✓	✓	✓	✓	✓	✓	✓	✓	✓	✓	✓	✓	✓	✓	✓	0	0
CR	4	4	3	4	3	3	4	3	4	4	3		3	3				
13	✓	✓	✓	X	✓	✓	✓	✓	✓	✓	✓	✓	✓	X	✓	✓	2	1
CR	4	4	3	4	3	3	4	3	4	4	4		3	2				
14	X	X	X	✓	✓	✓	✓	✓	✓	✓	✓	✓	✓	X	X	✓	5	3

Question number	Participant Number																# of incorrect responses	# of potential misconceptions	
	101	102	103	104	105	106	107	108	109	110	111	112	113	114	115	116			
CR	4	4	3	3	2	3	4	2	4	4	4		3	2					
15	✓	✓	✓	✓	✓	✓	✓	✓	✓	✓	✓	✓	✓	✗	✗	✓		2	0
CR	4	4	3	3	3	3	4	3	4	4	4		4	1					
16	✗	✗	✓	✓	✓	✓	✓	✓	✓	✓	✓	✓	✓	✗	✓	✓		3	2
CR	4	4	3	3	2	3	4	3	4	4	3		3	2					
17	✓	✓	✗	✓	✓	✗	✓	✓	✗	✓	✓	✓	✓	✗	✗	✓		5	3
CR	4	4	2	3	2	3	4	3	4	3	2		4	3					
18	✓	✓	✓	✓	✓	✓	✓	✗	✓	✓	✓	✗	✓	✗	✗	✓		3	0
CR	4	4	1		3	3	4	2	4	3	3		4	1					
19	✗	✗	✗	✓	✗	✓	✗	✓	✓	✓	✓	✓	✗	✗	✗	✓		8	6
CR	4	4	3	4	3	2	2	3	4	4	4		4	3					
20	✗	✗	✗	✓	✓	✓	✗	✓	✓	✗	✓	✓	✓	✗	✗	✓		6	6
CR	4	4	3	3	2	3	4	3	4	4	3		4	3					
	101	102	103	104	105	106	107	108	109	110	111	112	113	114	115	116			
CK %	60	65	75	90	85	95	80	95	96	90	95	95	85	25	50	100			
CK average score 80%																			
Confidence %	98	99	69	85	75	74	94	75	90	93	88	NA	85	59	NA	NA			
Difference (CK %- Confidence %)	-38	-34	+6	+5	+10	+21	-14	+25	+6	-3	+7	NA	0	-34	NA	NA			

The table shows that, in general, the participants performed well, with an overall average of 80% and only two participants achieving below 60%. The high scores are in line with the sample groups' qualifications and expertise. The test having been designed for students, it would be expected that experienced teachers would answer it with ease.

The scores from the CK tools were evaluated on two levels, firstly in terms of the most problematic topics and secondly in terms of sites of possible misconceptions. The topics that were most difficult are summarised and ranked in the Table 8 below. These topics were determined by looking at the number of incorrect responses.

Table 8: A summary of the most problematic topics in the CK assessment tool

Question number in CK assessment tool	Topics covered by a problematic items	Number of incorrect responses
19	Voltage: The emf ¹ of the battery is measured if there is no current in the external circuit	8
20	Parallel Connections: Current divides evenly in a parallel connection if the resistors have the same resistance, regardless of construction.	6
14	Parallel Connections: In a circuit when one additional resistor is added in parallel the current in the parallel branches remains the same.	5
17	Resistance: Resistance is a property of the material of the resistor	5
9	Current: Charge is conserved and part of the conducting material.	5

This data reveals that the two most difficult topics were those that related to voltage and parallel connections, with resistance also providing some problems. These questions did not test these concepts directly but required some additional understanding with regard to circuits. As an example Question 19 is shown below in Figure 11 below.

¹ Emf is an abbreviation for electromotor force and is defined as the potential difference across a battery without an external circuit.

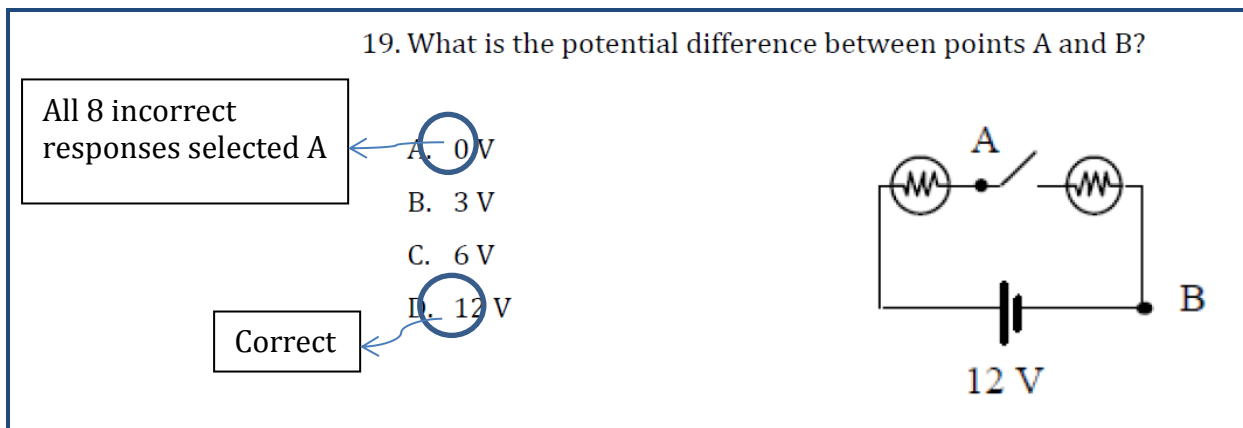

Figure 11: Diagram showing Question 19 from the CK assessment tool

Question 19 tests the measurement of emf across a battery but would require the respondent to know that with an open switch a voltage reading would be possible even with a resistor in place. In order to answer this question correctly the respondent would have to have a conceptual understanding of emf, resistors and be able to see that the voltage could still be measured between points A and B. If the construction was not identified the option selected was 0V. The significance of this item is that it shows that when circuits are drawn in slightly unconventional ways and the respondent does not have conceptual understanding they will not be able to answer correctly despite being able, in all likelihood, to define emf correctly. This is an example of the depth and subtlety of content knowledge required in the electric circuits by teachers.

Question 20 was the next worst performing item, with 6 incorrect answers. It tests to see if the respondent understands that the connecting wires in a parallel connection have no resistance, and that the way a parallel connection is constructed does not influence the current through the branches. Question 17 (5 incorrect responses) tested understanding that resistance is a property of the material of the resistor and Question 9 (5 incorrect responses) tests whether the respondent understands that charge is conserved. This misconception, of charge being conserved, is described in 'attenuation model'. Both these topics, of conservation of charge and properties of resistors, require conceptual understanding and are regarded as areas where potential misconceptions could exist.

The confidence rating allowed for another layer of analysis. Where a respondent selected the incorrect option but stated that they were confident that their answer was correct this was taken as a potential site of a misconception. This type of knowledge structure was seen to be different to when an incorrect answer was selected with a low confidence. In this situation the teacher shows a level of awareness that they are missing content and could take steps to rectify this. When a teacher feels that they have a good grasp of content when they do not or where they are unwilling to acknowledge that they lack confidence in a content area, this has the potential to impact how they convey these concepts to their students. While the confidence ratings show different types of conceptual gaps within the respondents both types have the potential to impact the knowledge transfer to students. A summary of the number and topics where these potential misconceptions exist is summarised in Table 9 below. Three participants did not fill in their confidence levels, rendering the data with regard to the misconception incomplete, but the data that was available still shows the trends of problematic topics.

Table 9: Summary of the number of misconceptions identified in the CK assessment tool

Question number in CK assessment tool	Topic where potential misconception exists	Number of incorrect responses with a high confidence rating	Number of incorrect responses with a low confidence rating
19	Voltage: The emf of the battery is measured if there is no current in the external circuit	6	1
20	Parallel Connections: Current divides evenly in a parallel connection if the resistors have the same resistance, regardless of construction.	6	0
10	Voltage: That the power delivered to a resistors dependent on voltage	4	0
5	Parallel Connections: Possible constructions of a parallel connection	4	0

The two most prevalent types of misconception that the teachers of this sample group held were in a parallel connections and the concept of voltage. The misconceptions held about parallel connections are documented in the literature. The results from this sample comply with those found in the literature (Engelhardt & Beichner, 2004). Question 10 required that the respondent understood that power increased with voltage and that voltage increased when cells are connected in series. The phrasing of the question was in terms of power delivery and may show that there is misunderstanding of the terminology and the inter-connectedness of concepts in electric circuits. This type of error is not directly referred to in the literature. The impact of language usage is potentially an interesting area of study. In both questions 20 and 5 slightly unconventional ways of circuit construction were used which tested the conceptual understanding of how electric circuits function as a system and how circuit components affect the whole circuit. These misconceptions are described by the 'local reasoning' and 'sequential model' misconceptions.

The relevance is that these observations will be seen when the results from the TSPCK are compared with these findings. The topics covered in the CK assessment tool are also covered in the TSPCK assessment tool. It would be expected that where there are content gaps and misconceptions the teacher will not be able to effectively transform this knowledge for their students. It is of particular interest to see if there is evidence of this in the TSPCK assessment tool responses. The content and concepts that were highlighted as being significant in this group from the CK assessment tool are:

- Parallel connections and the impact of adding resistors in parallel on a circuit.
- Voltage and in particular how changes within a circuit impact voltage, current, resistance, power and energy transfer.
- Terminology and how the use of different terminology impacts understanding of concepts within electric circuits.

4.4. Validity and Reliability of the CK assessment Tool

The items of the CK assessment tool had been validated in previous, but were nonetheless subjected to quantitative and qualitative analysis so as to confirm their validity for the purposes of this study. The two methods used to assess for validity are the interpretative and the statistical arguments. These two arguments for validity are in keeping with Mixed-Methods methodology used throughout this study. Validity is regarded as the extent to which an assessment measures the construct for which it was designed. The second part of this discussion is the reliability of the assessment tool, which asks the question 'Would the same assessment tool, given to another sample group of similar ability, produce a similar result?'

4.4.1. Step 7: The interpretative argument for validity and reliability of CK assessment tool.

In the tests from which the CK assessment tool questions originate all they had been used to evaluate competence and identify sites of misconceptions in students. It would be expected that experienced teachers should out-perform students, and as a minimum level all the participants should be able manage it with relative ease. Participant 114 achieved the lowest score (25%). This participant had taught science for the shortest period (2 years), and was not currently teaching the subject. Her demographic information explains, at least in part, her poor performance². The next three lowest scores of 50%, 60% and 65% were all from teachers not currently teaching Physical Science, even though all of them had taught the subject for more than 9 years in the past. These results are not substantially poor, but the fact that they achieved below the practising Physical Science teachers indicates that in order to engage with the conceptual nature of the CK assessment tool the respondent has to be currently engaged with the content.

² Respondent 114 has only taught physical science for 2 years and has not been active in science teaching for several years, she has however had several years' experience of teaching technology, which is why she was included in the sample group.

The rest of the respondents all achieved above 75%, with the highest score (100%) achieved by the longest-serving teacher of 45 years. The participants whose demographic information might lead one to expect them to have the weakest content knowledge did indeed perform the poorest i.e. those who had been teaching science for the shortest period of time or those were no longer actively involved with science education and taught other related subjects, such as Mathematics. Notwithstanding all the participants having some measure of tertiary training in science, it would appear that current engagement in the topic is important to maintain a level of content knowledge.

Here it is possible to note that, based on the results of the tests, the CK assessment tool is able to distinguish between teachers with good CK and those without. The addition of the confidence rating also potentially offers information of the misconceptions that teachers hold. From the analysis of confidence ratings in relation to incorrect responses it is possible to pinpoint possible sites of misconception. This will be of particular interest when the TSPCK scores are compared.

4.4.2. Step 7 Continued: The statistical analysis of the CK assessment tool for validity and reliability

The CK assessment tool was also subjected to Rasch analysis. The Rasch statistical model measures the extent to which a single construct is being measured, in this case, content knowledge of electric circuits. This statistic is based on the difference between the observed score and the estimated ability of the person (Linacre, 2012). A conventional range of between -2 and +2 is considered a good fit and an argument for validity. Rasch predicts two 'fit' statistics, namely, '*Infit*' and '*Outfit*'. The *Infit* score is a measure of performance in relation to item difficulty. A positive correlation between person ability and item difficulty indicates construct validity. The *Outfit* statistic is a measure of those items beyond ('outside') a person's ability.

Table 10 shows the person measure statistics of the Rasch analysis. The key statistics of this data are the ZSTD (Standardised z- score) and the measure statistics. The Z-Score is a statistical measurement of a score's relationship to the mean in a group of scores. A Z-score of 0 means the score is the same as the mean. The ZSTD range for validity is between -2 and +2. These scores measure to what extent a single construct is being measured by this sample group. The measure statistics indicate how difficult the respondents found the test: the more negative the more difficult the test.

Table 10: Table showing the person measure statistics generated by Rasch analysis

Person fit CK test
 ZOU698WS.TXT Dec 21 10:24 2014
 INPUT: 16 Person 20 Item REPORTED: 16 Person 20 Item 2 CATS MINISTEP 3.81.0

 Person: REAL SEP.: 1.54 REL.: .70 ... Item: REAL SEP.: 1.16 REL.: .57

 Person STATISTICS: MEASURE ORDER

ENTRY NUMBER	TOTAL SCORE	TOTAL COUNT	MEASURE	MODEL S.E.	INFIT MNSQ	ZSTD	OUTFIT MNSQ	ZSTD	PTMEASURE-A CORR.	EXP.	OBS%	MATCH EXP%	Person
16	20	20	4.55	1.83	1.06	.4	.73	.3	.19	.21	100.0	100.0	116
6	19	20	3.27	1.05	1.13	.4	1.16	.6	.12	.21	94.1	94.0	106
8	19	20	3.27	1.05	1.06	.4	.73	.3	.19	.21	94.1	94.0	108
9	19	20	3.27	1.05	1.06	.4	.73	.3	.19	.21	94.1	94.0	109
11	19	20	3.27	1.05	1.06	.4	.73	.3	.19	.21	94.1	94.0	111
12	19	20	3.27	1.05	1.13	.4	1.16	.6	.12	.21	94.1	94.0	112
4	18	20	2.45	.79	1.27	.7	2.25	1.2	.09	.29	88.2	88.0	104
10	18	20	2.45	.79	.91	.0	.54	-.1	.35	.29	88.2	88.0	110
5	17	20	1.91	.68	.91	-.1	.67	-.2	.40	.35	88.2	82.5	105
13	17	20	1.91	.68	.98	-.1	.78	.0	.36	.35	88.2	82.5	113
7	16	20	1.49	.62	.87	-.3	1.09	.4	.42	.40	88.2	78.4	107
3	15	20	1.12	.59	.72	-1.1	.56	-.8	.57	.44	82.4	74.5	103
2	13	20	.48	.56	.84	-.7	.70	-.8	.60	.51	70.6	69.8	102
1	12	20	.18	.55	1.00	.1	.89	-.2	.56	.55	64.7	70.4	101
15	10	20	-.43	.56	1.08	.4	1.09	.4	.57	.60	70.6	73.3	115
14	5	20	-2.49	.81	1.02	.2	1.21	.5	.69	.72	88.2	88.0	114
MEAN	16.0	20.0	1.87	.86	1.00	.1	.95	.2			85.9	84.4	
S.D.	4.0	.0	1.72	.32	.13	.5	.41	.5			9.3	8.8	

The ZSTD scores are all between the range of -2 and +2, which indicates statistical validity. Only 2 ZSTD scores are above 1 indicating a high degree of construct validity.

The measure scores are mostly positive, which indicates that the respondents found the test manageable. Only 2 respondents have negative measure scores which indicate that they found the assessment to be difficult. This result is in keeping with the design intent of the CK assessment tool. The questions were originally designed for students so it would be expected that skilled teachers would be able to cope with the level of test easily.

Table 11 is a statistical summary of the items for the CK assessment tool, ranked from the most difficult item to the easiest.

Table 11: Table showing the item measure statistics generated by Rasch analysis

13-698ws
 ZOU698WS.TXT Dec 21 10:24 2014

TABLE 13.1 Content corrected
 INPUT: 16 Person 20 Item REPORTED: 16 Person 20 Item 2 CATS MINISTEP 3.81.0.

Person: REAL SEP.: 1.54 REL.: .70 ... Item: REAL SEP.: 1.16 REL.: .57

Item STATISTICS: MEASURE ORDER

ENTRY NUMBER	TOTAL SCORE	TOTAL COUNT	MEASURE	MODEL S.E.	INFIT MNSQ	INFIT ZSTD	OUTFIT MNSQ	OUTFIT ZSTD	PTMEASURE-A CORR.	EXP.	EXACT OBS%	MATCH EXP%	Item
19	8	16	2.06	.62	.49	-2.2	.40	-.8	.78	.56	100.0	73.9	19
20	9	16	1.67	.63	.60	-1.5	.49	-.8	.75	.58	93.3	75.2	20
5	11	16	.84	.68	1.54	1.4	1.68	1.1	.36	.60	66.7	79.8	5
9	11	16	.84	.68	1.10	.4	.92	.1	.57	.60	80.0	79.8	9
14	11	16	.84	.68	.46	-1.8	.33	-1.3	.82	.60	93.3	79.8	14
17	11	16	.84	.68	1.46	1.2	1.98	1.5	.36	.60	66.7	79.8	17
1	12	16	.35	.73	1.00	.1	.70	-.2	.62	.59	80.0	82.2	1
2	12	16	.35	.73	1.27	.7	1.72	1.1	.45	.59	80.0	82.2	2
10	12	16	.35	.73	.99	.1	.70	-.2	.62	.59	80.0	82.2	10
18	12	16	.35	.73	1.41	1.0	2.75	1.9	.32	.59	80.0	82.2	18
16	13	16	-.23	.81	.80	-.3	.39	-.5	.69	.58	80.0	85.9	16
6	14	16	-.99	.95	.73	-.3	.31	-.2	.66	.55	93.3	90.7	6
8	14	16	-.99	.95	1.01	.2	.90	.4	.52	.55	93.3	90.7	8
13	14	16	-.99	.95	1.10	.4	2.18	1.1	.42	.55	93.3	90.7	13
15	14	16	-.99	.95	.50	-.8	.20	-.4	.73	.55	93.3	90.7	15
3	15	16	-2.15	1.24	1.65	.9	.49	.0	.35	.46	86.7	94.2	3
11	15	16	-2.15	1.24	.32	-.8	.08	-.7	.65	.46	100.0	94.2	11
4	16	16	-3.75	1.93	MINIMUM MEASURE				.00	.00	100.0	100.0	4
7	16	16	-3.75	1.93	MINIMUM MEASURE				.00	.00	100.0	100.0	7
12	16	16	-3.75	1.93	MINIMUM MEASURE				.00	.00	100.0	100.0	12
MEAN	12.8	16.0	-.56	.99	.97	-.1	.95	.1			85.9	84.4	
S.D.	2.2	.0	1.72	.43	.40	1.0	.77	.9			9.9	6.2	

TABLE 13.3 Content corrected
 INPUT: 16 Person 20 Item REPORTED: 16 Person 20 Item 2 CATS MINISTEP 3.81.0

The first column ranks the items from most difficult and shows statistically question 19 was the most difficult. The measure statistics (2nd red column) give a numerical value to this difficulty. The more positive the value the more difficult, negative values indicate easier items. The overall measure statistic for the items was -0.56 indicating that the teachers who completed the CK assessment tool found it manageable. The blue columns are the ZSTD scores which indicate statistical validity, in other words to what extent the intended measured construct is being assessed. In this case the construct is content knowledge in electric circuits. The ZSTD scores all fall within the accepted -2 to +2 range, with the exception of Question 19 that falls just outside this range. In the heading an item separation value is given (green block). This is a measure of the range of difficulty between the items, the larger the number the wider the range. The calculated value of 1.16 is relatively low and indicates that there is not a wide range of difficulty in

the assessment tool. Potentially there are two reasons for this, firstly the sample size is too small and homogenous to establish a wide range and secondly the CK assessment tool items were originally designed for students which teachers should find relatively easy.

The Rasch analysis allows for a mapping of person against items, shown below in Figure 12. The figure arranges both items and persons along a vertical scale. The items are shown on the right of the map and are arranged vertically from the most difficult to the easiest. The persons are arranged on the left and are ranked from highest to lowest ability.

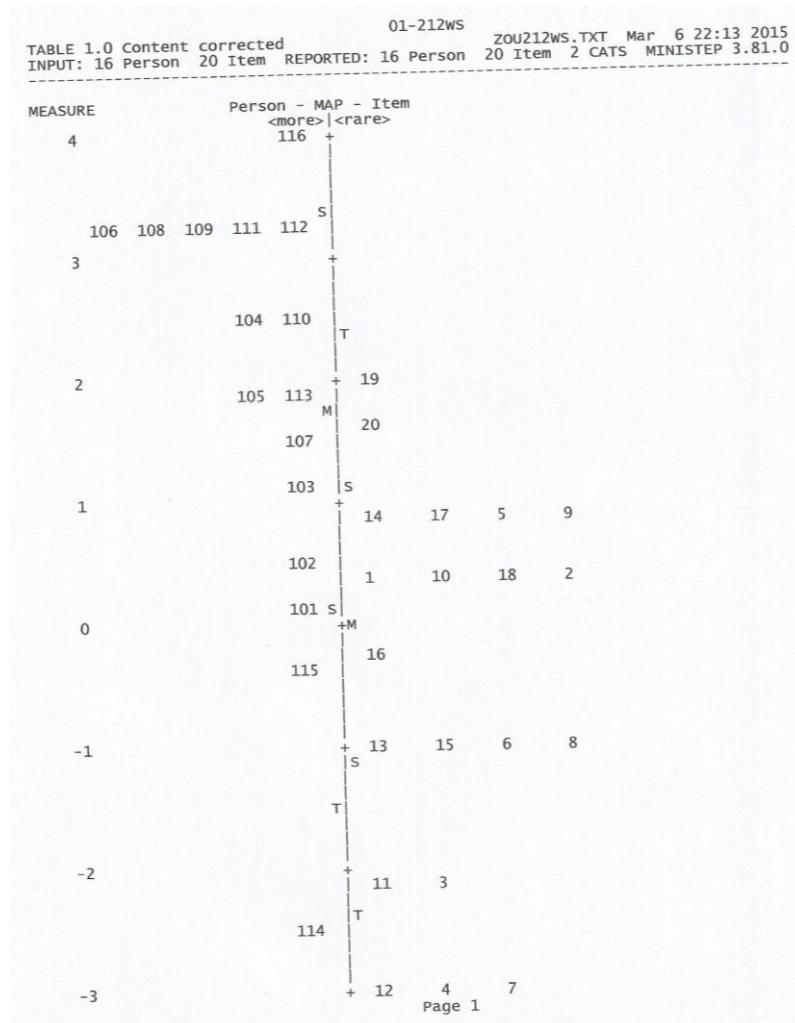

Figure 12: Item-Person Map of the CK assessment tool generated by Rasch analysis.

This map shows graphically that the person ability is clustered toward the top end and the item measures are clustered in the middle and lower end of difficulty. This data reveals that the sample population has good content knowledge in electric circuits and that the CK assessment tool is not too difficult.

The Rasch analysis also allows for the calculation of reliability. Item reliability is a measure the probability that similar a sample population will produce similar results if they were given the same test and person reliability is a measure of the probability of the this sample population getting similar results if they were given a different tests that measures the same construct. The nearer this value is to one the more reliable it is regarded. Table 12 is a summary of the reliability data.

Table 12: Summary of the Rasch statistical analysis of the CK assessment tool

Content Data									
Person					Item				
Person	16 INPUT		16 MEASURED		INFIT		OUTFIT		
	TOTAL	COUNT	MEASURE	REALSE	IMNSQ	ZSTD	OMNSQ	ZSTD	
MEAN	16.0	20.0	1.87	.88	1.00	.1	.95	.2	
S.D.	4.0	.0	1.72	.33	.13	.5	.41	.5	
REAL RMSE	.94	TRUE SD	1.44	SEPARATION	1.54				Person RELIABILITY .70
Item	20 INPUT		20 MEASURED		INFIT		OUTFIT		
	TOTAL	COUNT	MEASURE	REALSE	IMNSQ	ZSTD	OMNSQ	ZSTD	
MEAN	12.8	16.0	-.56	1.04	.97	-.1	.95	.1	
S.D.	2.2	.0	1.72	.43	.40	1.0	.77	.9	
REAL RMSE	1.12	TRUE SD	1.30	SEPARATION	1.16				Item RELIABILITY .57

Output written to C:\winsteps\examples\ZOU795WS.TXT
 CODES= 01

The person reliability score of 0.7 (in the blue block) indicates a good level of reliability and the item reliability score of 0.57 (in the red block) is also acceptable. The nearer these scores are to 1 to more statistically reliable they are. The small sample size does impact on these values so this level of reliability with small sample size was taken as a statistical indicator of reliability.

The overall statistical data supports the argument for validity. A weakness in the data is the relatively small sample population size, but even with this small size the argument for validity is credible. The purpose of the CK assessment tool is to test the premise that good CK is necessary for good TSPCK. For the purpose of determining relative levels of

content knowledge the CK assessment tool meets this requirement because even within this generally competent sample population there is a range of scores. The CK assessment tool results can be considered valid and used in conjunction with the TSPCK assessment tools scores.

4.5. Conclusion

The CK assessment tool was developed using pre-existing assessment tools that have already undergone processes to determine their validity. However, this established validity was a good starting point but insufficient for the wholesale use of these tests. The three tests of; (i) Engelhardt & Beichner, (2004): Determining and Interpreting Resistive Electric Circuit Test (DIRECT) (ii) Pesman & Eryilmaz, (2010): Three-Tier Test, and (iii) the 'Capacitor-Aided System for Teaching and Learning Electricity' (CASTLE), Wainwright (2004) were evaluated against the content they covered, the misconceptions they covered and their relative ease of use. The overall average for the sample group was 80% indicating that this assessment tool was accessible for most of the sample population, however certain questions did pose more difficulty and a pattern of the most prevalent misconceptions held within is this group of teachers emerged. The interpretative argument is that the ranking for the scores of the CK fitted well with the demographic information provided. The quantitative argument is given using the Rasch analysis which showed that the CK assessment tool fell within acceptable ranges for validity and reliability.

The CK assessment tool is not designed in isolation and is meant as supporting evidence for explaining teachers' level of TSPCK. The process of design, scoring and validation of the TSPCK assessment tool will be discussed in the next chapter.

Chapter 5 – Development of the TSPCK assessment tool

In this chapter I outline the process of developing the Topic-Specific Pedagogical Content Knowledge (TSPCK) assessment tool for piloting, the process of evaluating and collecting data, the adaptations after piloting and the development of the final TSPCK assessment tool. Particular emphasis is given to the development of the assessment rubric used to categorise responses in the TSPCK assessment tool

5.1. Introduction

This chapter describes the process of designing the items for the TSPCK assessment as well as the measures taken to ensure the validity and reliability of the scoring the TSPCK assessment tool responses. In Chapter 6 arguments for the validity of the TSPCK assessment as a tool for testing levels of TSPCK are presented. This design process and the care taken to ensure validity are key to answering the research questions of determining the most appropriate way to measure TSPCK in electric circuits.

Kind (2009) mentions the difficulty of measuring PCK directly because it is tacit knowledge, and teachers do not directly verbalise their 'PCK'. It is an internal and personal construct. The framework of Mavhunga and Rollnick (2013) further develops the idea of PCK to the more specific Topic-Specific PCK. A key premise of their model is the importance of content knowledge before it can be transformed into TSPCK, a relationship confirmed by Borowski et al (2011). This necessitates the design of two inter-related assessment tools, namely the CK and TSPCK assessment tools. The design and validation of the CK assessment tool was described in the previous chapter. However, its construction should be seen as integral to the construction of the TSPCK tool. So, although this chapter focuses on the development of the TSPCK assessment tool, it needs to be understood that its design was not in isolation from that of the CK

assessment tool. In Chapter 6 the relationship of the data between the two tools will be evaluated.

5.2. Development of TSPCK assessment tool

5.2.1. Summary of the steps taken in the development of the TSPCK assessment tool.

The development of the TSPCK assessment tool broadly followed the 'rational method' of construction, a process outlined by Oosterveld and Vorst (1996), this procedure was also followed for the development of the CK assessment tool and is described in subsection 4.1. Their method emphasises content validity, and uses empirical data and judgements of experts in the construction of items (Rohaani et al, 2009). A summary of the processes that were followed to design and validate the TSPCK assessment tool is outlined in the flow diagram below, Figure 13. This chapter discusses Steps 1 to 7. The final step 8, which is the validation of the assessment tool, is a critical part of the study and is discussed separately in Chapter 6. The eight steps are:

- (i) Step 1: Conceptualising items for the TSPCK pilot assessment tool within the Mavhunga and Rollnick framework, and within the same content bounds as the CK assessment tool. Pre-pilot assessment tool developed.
- (ii) Step 2: Pre-pilot assessment tool evaluated by reference team and pilot TSPCK assessment tool developed.
- (iii) Step 3: Pilot TSPCK assessment tool given to 2 science teachers and 1 educational researcher.
- (iv) Step 4: Feedback from the pilot group used in the design of the final TSPCK assessment tool.
- (v) Step 5: Final TSPCK assessment tool was completed by a sample group of 16 science teachers.
- (vi) Step 6: Development process of TSPCK rubric to categorise the responses to the TSPCK assessment tool and validation of the categorisation.

(vii) Step 7: TSPCK responses categorised.

(viii) Step 8: Results from the categorising subjected to quantitative and qualitatively analysis to establish the level of validity. This is discussed in detail in Chapter 6

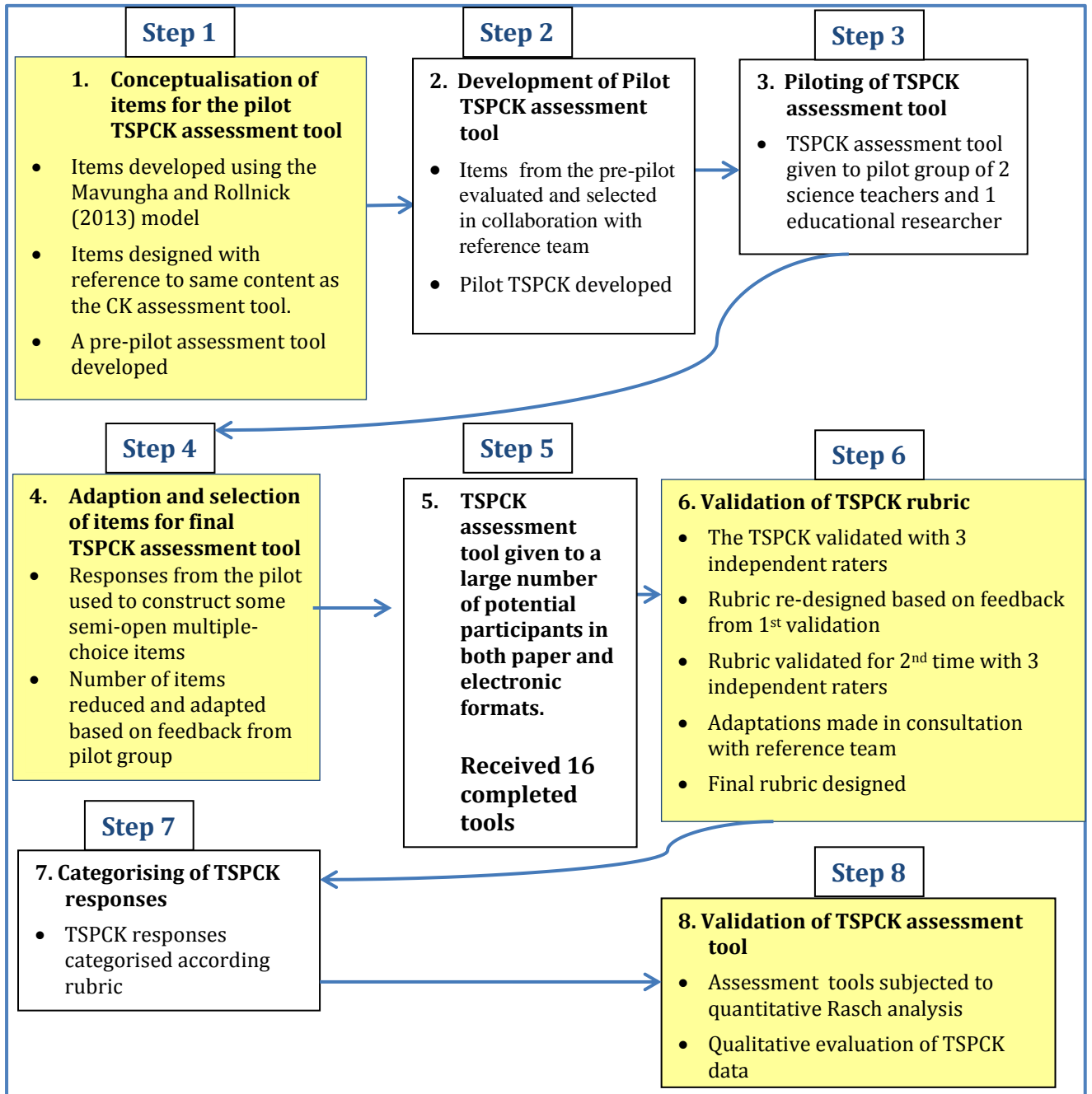

Figure 13: A flow diagram of the steps involved in the design and validation of the TSPCK assessment tool

5.2.2. Step 1: Conceptualisation of items for the TSPCK assessment tool

The aim of the design of the TSPCK tool was to include items that elicited evidence of how teachers transform content knowledge, and to take it a step further by rating and ranking teacher responses. While there is some debate on how to measure PCK, even whether it is possible to measure the construct, the Mavhunga & Rollnick model (2013) provides a framework to structure an assessment tool to measure TSPCK in electric circuits. The focus on a specific topic allows for a narrower and more defined focus, which in turn allows for more clarity and the possibility of a rated assessment. A detailed explanation of Mavhunga & Rollnick model (2013) was given Chapter 2; to recap here, they identified five categories to define how teachers transform content knowledge into TSPCK. These categories are:

- Category A – students’ prior knowledge and misconceptions,
- Category B - curricular saliency,
- Category C - what is difficult to teach,
- Category D - representations and analogies and
- Category E - conceptual teaching strategies.

The development of the tool was completed in three stages. The first was the development of a pre-pilot tool, developed as a discussion document and a starting point for the development of items for the pilot tool. The second stage was the actual development of the pilot tool. It was developed to extract detailed responses from teachers that could possibly be used in the final TSPCK tool. The final stage of the development was to use the responses from the pilot tool, together with the expertise of a reference team, to develop the final TSPCK tool. The above TSPCK categories, together with the key content sub-topics extracted from Loughrans’ CoRe and the CAPS document required to teach electric circuits, were used to scaffold the development the TSPCK assessment tool.

5.2.3. Step 1 Continued: Defining the content to be covered in the TSPCK assessment tool.

The content covered in the TSPCK is identical to that selected for the CK assessment tool. The two sources used were Loughran's CoRe and the CAPS document. A detailed description of the content selected is given in Chapter 3. The main content in electric circuits topics covered in the TSPCK are:

- (i) Current
- (ii) Voltage
- (iii) Energy
- (iv) Electric Fields
- (v) Resistance
- (vi) Parallel Connections

Another facet used to determine what was to be included in the assessment tool was common misconceptions about electric circuits. These are documented in the science literature, (Loughran, Berry, & Mulhall, 2006, Tarciso Borges & Gilbert, 2010, and Wainwright, 2007). Selecting the misconceptions was done in consultation with the reference team. The major misconceptions selected for this tool are listed below.

- (i) **'attenuation model'** - Current is 'used up'
- (ii) **'local reasoning'** - Circuit not viewed as a system. Any change affects only the component being changed and not the whole circuit
- (iii) **'parallel circuit misconceptions'** - Increase of resistors in parallel increases the overall resistance
- (iv) **'sequential model'** - A change in a circuit affects only the components after the component.

These misconceptions overlap with the misconceptions uncovered in the CK assessment tool. The misconceptions found in the CK assessment tool with regard to voltage, alternative ways of constructing circuits and the inter-relatedness of electric circuit

terminology are not explicitly mentioned in this list but these concepts do form part of the understanding that contributes to the 'local reasoning' and 'sequential model' misconception descriptions. The misconceptions found are of particular interest in the TSPCK assessment tool because these are the concepts that teachers need to accurately transform for their students.

5.2.4. Step 2 and 3: The development of items for the pre-pilot and pilot TSPCK tool

The design of the TSPCK items was more challenging than selecting and adapting content items. Two criteria to be satisfied were, firstly, that the items needed to be included as one of Loughran's 'Big Ideas' or as part of the CAPS document, and secondly, that they were structured according to the five categories of the Mavungha & Rollnick model. The items for the pilot tool were constructed with the purpose of exposing how teachers respond in different teaching scenarios relating to electric circuits. To this end, the items for the pilot were designed to be open-ended and broad enough to allow for a deeper response. A brief explanation of each category was given on the front page of the Pilot Tool to assist the respondents in their thinking, and to highlight the idea that the goal was not to elicit 'right' or 'wrong' answers, but rather to uncover the breadth and depth of teacher thinking around teaching electric circuits.

Within this framework, as a starting document, a pre-pilot TSPCK assessment tool was developed for discussion with the reference team. The number of items was too great for the actual pilot TSPCK assessment tool, but it served as a discussion for items to be selected, both for the pilot tool and ultimately for the final TSPCK assessment tool. The number and type of items selected for the pilot TSPCK assessment tool are outlined in the sub-sections below. The items selected are discussed per category.

5.2.5. An overview of the structure of the pilot TSPCK assessment tool

An overview and examples for each category is given below

Category A - 'student prior knowledge and misconceptions'

In this category there were 4 open-ended questions covering the following content areas and/or common misconceptions: (i) current remains constant throughout a series circuit, (ii) a complete circuit is needed for current to flow, (iii) the particle nature of charge and charge as an energy carrier and (iv) the effect of resistors in parallel on current. An example of the open-ended nature of the given below in Figure 14

1. How would you respond to student that asks: "How do the charges 'know' how much energy they will need to get around the circuit?"

Write your response here:

Figure 14: An example of a pilot item for Category A

Category B - 'Curricular Saliency'

In this category a list of 'Big Ideas' (Loughran, Berry, & Mulhall, 2006) and subordinate ideas was given. The respondents were asked to select 5 of them and to comment on how they would sequence them in a teaching program, and to include their reasoning. The list of topics is a mix of "Big Ideas' from Loughran and topics in CAPS. In addition, they were also asked to complete a concept map and to expand on why they thought teaching electric circuits is important. Figure 15. is an example of an item for this category.

5. Review the list of concepts relating to electric circuits below. Select five of what you regard as the most critical. State the sequence in which you would teach them, and also your reason for doing so in the table below:
- a. To obtain an electric current there needs to be a continuous loop from one battery terminal to the other terminal
 - b. An electric current is the flow of net charge.
 - c. Parallel connections in a circuit are current dividers
 - d. The materials that make up the circuit provide the charged particles when there is an electric current
 - e. A battery provides the energy for an electric current
 - f. Voltage can be defined as $J.C^{-1}$
 - g. Ohm's law can be defined by $V = \frac{R}{I}$
 - h. When there is a current, energy flows from the battery to the user.
 - i. Resistance is the opposition to current flow
 - j. A battery creates an electric field within the materials that make up the circuit. The electric field is the cause of current flow.
 - k. The resistance of a parallel connection can be calculated by $\frac{1}{R_T} = \frac{1}{r_1} + \frac{1}{r_2} + \frac{1}{r_3} \dots$
 - l. An electric circuit is a system in which changes in one part can affect other parts
 - m. Power is the rate at which energy is dissipated by the circuit component.
 - n. Current is measured with an ammeter, and voltage by a voltmeter

Sequence of concept	Reason

Figure 15: An example of a pilot item in Category B

Category C - 'What is difficult to teach'

In this category the teachers were asked to give concepts they thought were difficult to teach and to give reasons for their answer. They were also asked to give examples of electric terminology that, in their experience, students struggle to understand. Figure 16 as an example of an item in this category

What three concepts have you observed that students struggle most to understand?
What do you think is the reason for this?

Concept	Reason
1.	
2.	
3.	

Figure 16: An example of a pilot item in Category C

Category D- 'Representations and analogies'

In this category representations and analogies were given to explain flow of current in a parallel circuit, and the electric circuit as an integrated system. The respondents were asked to give reasons why they liked or disliked a representation and if/how they would use it in their own practice. Figure 17 is an example of one the items.

11. Once the concepts of voltage, current and resistance have been covered separately, they need to be integrated as a system. The following representations and analogies are designed to show the inter-relationship of components in a circuit.

Select the **two** you would most likely use in a classroom, and give reasons for your selection.

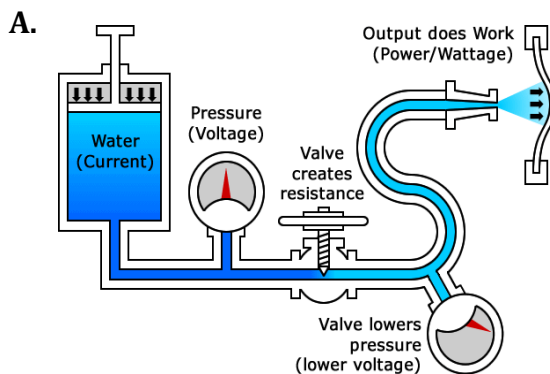

<http://www.tagisangrobotics.ph/downloads/TRC%202014%20Training%20Manual%20softcopy.pdf>

B. A circuit is like a river. Water flows down under the influence of gravity, which is like the battery in a circuit, and the water is like the current. The wider the river, the easier for the water to flow. In a river there are obstacles, like rocks and bends, which can interrupt flow. These are like resistors. An obstruction in one part of the river will impact the flow throughout the river.

C. A circuit is like a fish tank

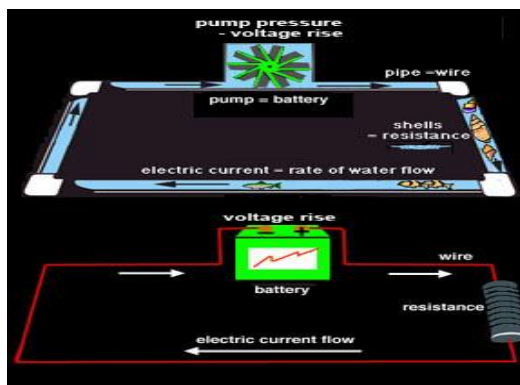

<https://encryptedtbn2.gstatic.com/images?q=tbn:ANd9GcSQgwaHGpeCGZa8hsjXUghGAZJ8R8prVskMwcZobaV3j4M0joxamk1TBdY>

Figure 17: An example of a representation Category D in the pilot TSPCK assessment tool

Figure 17 – Continued

D. Role plays can be used such as the one described below:

Many teachers like using the Jelly Bean Role Play as an approach to teaching about electric circuits. Two students are assigned the roles of 'battery' and 'light globe'. The 'battery' is given a bag of jelly beans, which represents 'energy'. The battery and the light globe stand about 3 or 4 meters apart. About 10 more students act as 'movable charged particles'. They are handed two jelly beans each which they all give to the 'light bulb' as they pass it. The 'light globe' eats the jelly bean and then does something (e.g., waves his or her arms. This movement represents the action of a light globe producing heat and light. The role-play is intended to show that in an electric circuit containing a single battery and light globe the battery supplies a constant amount of energy per charged particle, and that this energy is transferred to the light globe where it appears as light and heat. (Loughran, Berry, & Mulhall, Chapter 8 Electric Circuits, 2006)

E. Physical model

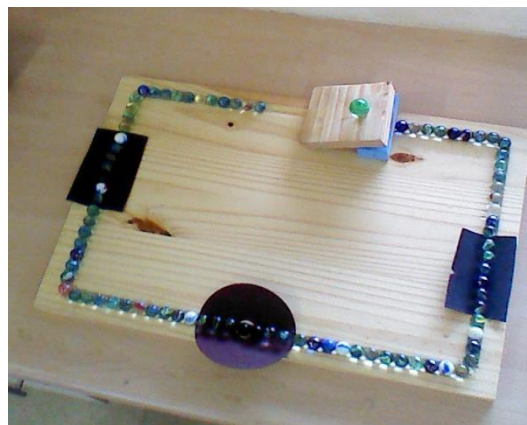

(own picture)

Representation/Analogy	Reason for Selection
Choice 1	
Choice 2	

Category E - 'Conceptual teaching strategies'

The items in this category are intended to integrate all the previous categories into a single question. A single item was designed for this category. An extract from a textbook task was given, together with partially-correct answers offered by students. The participants were then asked which concepts they considered to have been grasped, which were lacking, and what strategies they would employ to respond to these gaps. An example of one of these items is given in Figure 18.

Study the student responses to questions are given below and describe what corrective strategies you would employ.

The following diagram represents Sparky, who departs the cell full of energy. Answer the following questions with reference to the diagram.

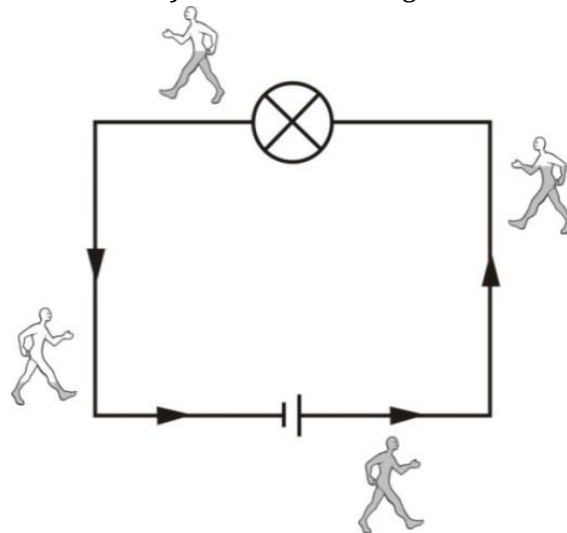

(a) What is represented by Sparky?

Electricity

(b) What is represented by the shaded areas in his body?

Current

(c) Where does Sparky get the energy from?

Battery

(d) What happens while Sparky moves from the positive terminal to the negative terminal of the cell?

Sparky's charge gets used up

(e) Is it correct to say that the electric current is used up? Explain your answer.

Yes because as the current moves around the circuit., it gets used for things like heat and light and by the time it gets back to the battery all the current is finished.
(du Toit, 2006 p. 98)

Figure 18: An example of a pilot item from Category E

Figure 18. Continued

a. What conceptual ideas does this student have in place

Write your response here:

b. What are the key conceptual gaps, in your opinion, that this student demonstrates?

Write your response here:

c. What specific strategies would you employ to bridge these gaps?

Write your response

The responses from the pilot group were evaluated and with discussion with the reference group, these responses were used to develop the final TSPCK assessment tool

5.3. The development of the final TSPCK assessment tool

The final TSPCK assessment tool was designed in consultation with the reference team, which evaluated the responses to the pilot. In this section I describe the adjustment made from the pilot to the final tool. A primary challenge of this process was to reduce the number of items to make answering the tool quicker, while retaining the opportunity to extract answers with enough depth. The responses from the pilot were used as the basis to create semi-closed responses for the final TSPCK assessment tool.

This process of evaluating the responses to the pilot tool favoured the questions that elicited the greatest depth of response; the questions that best covered the selected content and common misconceptions. Issues of language and ease of response were also taken into consideration.

5.3.1. Step 4: Adaption and selection of items for final TSPCK assessment tool from the pilot TSPCK tool

The following sub-section describes the adjustments made from the pilot to the final tool.

Category A – Student prior learning

The pilot tool contained 4 items dealing with prior learning and misconceptions. This was reduced to 2 items in the final tool. The content areas covered were: ‘current remains constant in a series circuit’ and ‘the effect of adding a resistor in parallel’. These content areas also relate to the most prevalent sites of misconceptions held by the teachers in the sample group as seen in the CK assessment tool. The items were altered from being open-ended to having a multiple-choice format. The options for the multiple-choice items were developed from answers given in the pilot tool, from literature (Tarciso Borges & Gilbert, (2010), Loughran, Berry, & Mulhall, (2006), Wainwright, (2007)) and my own classroom practice. All the options for these questions were designed to be conceptually correct, with the focus of the assessment to uncover the reasoning behind a particular selection. The purpose of both items was to uncover whether or not a teacher recognized and acknowledged a misconception and then how he/she responded to it. At the simplest level a teacher might simply repeat the correct material, or at the next level she could re-phrase and re-explain the material; or a more developed teacher would employ more complex strategies. These different levels of response were coded according to an assessment rubric, the design of which is more fully outlined in sub-section 5.4 below.

Figure 19 is an example of how this process was carried out. In Figure 19 an extract is taken from one of the pilot participants, and the next extract shows how this response is then used in the final item.

Item in pilot TSPCK tool

Category A - Student prior knowledge

A1. How would you comment in writing to the student that **selects B** as the answer to the question below, where A_1 and A_2 are ammeters

Which one of the following options is correct for the circuit shown below

- A. $A_2 > A_1$
- B. $A_1 > A_2$**
- C. $A_1 = A_2$

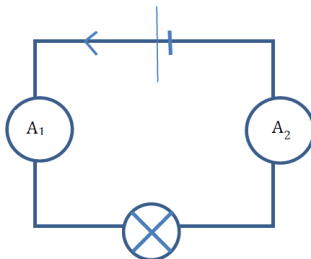

Write your response here

Participant response verbatim

Current is the rate of flow of charge. In this case the charge flowing is electrons. Electrons are particles that have mass and cannot disappear as they flow around the circuit. It is the same as the number of cars travelling on a road. Each ammeter is like a device that measures the number of cars passing a given point. The road does not split, so the number of cars passing each point is the same. None can just disappear off the road. It is the same with the flow of electrons. The ammeter, 1, measures the number of electrons flowing through ammeter 1, which measures how many electrons pass through it a given time.

The options given in the final TSPCK tool to the same question. The open ended response given in the pilot tool is used in the generation of the options in the final TSPCK assessment

Response A: Keep in mind that this is a series circuit so current is not divided; therefore the correct answer is C. The current is the same throughout the circuit

Response B: **Current is the rate of flow of charge. In this case the charge flowing is electrons. Electrons are particles that have mass and cannot disappear as they flow around the circuit.** None of the electrons disappear through the circuit so the correct answer is C

Response C: Charged particles move under the influence of the electric field created by the battery, all the charged particles are in the same field, with the easiest path being in the single, undivided conductor. The flow of the charged particles is same throughout, so the correct answer is C

Response D: None of the above

Figure 19: An Extract from the TSPCK pilot tool showing an example of a teacher response. The portion used in the final TSPCK tool is highlighted

The question was selected for the final TSPCK tool because it is a common misconception held by students, and it would be expected that teachers would have a sense of how they would respond. The options given for the semi-closed item in the final instrument include (i) a correct but very simple response, (ii) a response that draws on the definition of current as the rate of charge flow, and (iii) a response that uses an explanation of charges moving in uniform electric fields. None of the options is incorrect, and each could be used in different situations. The purpose of the item is to draw out the reasoning behind the selection.

Category B - Curricular Saliency

The pilot tool contained 4 items, with the structure of the questions drawn directly from Mavhunga & Rollnick (2013). Only slight changes were made from the pilot to the final TSPCK tool. An example of these changes is given in Figure 20. In the pilot tool the participants had to select and sequence 5 concepts; in the final tool this was reduced to 3 concepts.

B1. Review the list of concepts relating to electric circuits below.

Select five concepts that you regard as the most critical concepts.

State the sequence in which you would teach these five concepts and your reason for doing so in the table below

Original item in the pilot TSPCK

- a. To obtain an electric current there needs to be a continuous loop from one battery terminal to the other terminal
- b. An electric current is the net flow of charge.
- c. Parallel connection in a circuit are current dividers
- d. The materials that make up the circuit provide the charged particles when there is an electric current
- e. A battery provides the energy for an electric current
- f. Voltage can be defined as $J.C^{-1}$
- g. Ohm's law can be defined by $V = \frac{R}{I}$
- h. When there is a current, energy flows from the battery to the user.
- i. Resistance is opposition to current flow
- j. A battery creates an electric field within the materials that make up the circuit. The electric field is the cause of current flow.
- k. The resistance of a parallel connection can be calculated by $\frac{1}{R_T} = \frac{1}{r_1} + \frac{1}{r_2} + ..$
- l. An electric circuit is a system in which changes in one part can affect other parts
- m. Power is the rate at which energy is dissipated by the circuit component.
- n. Current is measured with an ammeter, and voltage by a voltmeter

Figure 20: Extracts from the pilot TSPCK assessment tool showing the changes made in the final TSPCK assessment tool.

Figure 20 Continued

Original
open-ended
item split
into two

Number reduced from 5 to 3 concepts

B1. Review the list of concepts relating to electric circuits below. (same as above)

Select and rank **three** foundational concepts that you regard as both basic and central concepts in electric circuits.

Write the number of the concepts you have selected, in order of importance.

Concepts
Concept 1.
Concept 2.
Concept 3.

B2. Using the three selected concepts from B1, give the sequence in which you would teach them, and your reasons for doing so

Concept	Reason for sequence

The focus of the questions was to evaluate how teachers rank, sequence and inter-relate topics within electric circuits. A list of topics was provided in the question that included

main ideas and subordinate ideas. This list was derived mostly from Loughran, CoRe and a few from CAPS. In the CoRe 'Big Ideas' are delineated and are largely conceptual in nature with subordinate ideas which link to them. The premise is that teachers with more developed PCK are better able to separate and sequence 'Big Ideas' from subordinate ones.

In this Category in the pilot tool the respondents were also asked to create a concept map using their selected main ideas, and to link them to other subordinate ideas. This item was retained unaltered in the final tool because it yielded detailed responses in the pilot. The final item in this category is an open-ended question which requires teachers to reflect why they think teaching electric circuits is important. These items were left unaltered from the pilot to the final TSPCK tool.

Category C - What is difficult to teach

Two items designed for this category in the pilot, asked, firstly, what concepts the teacher finds difficult to teach, and secondly, to select specific terminology that poses difficulty for students. In the final TSPCK tool the structure of the item was rephrased and scaffolded instead of being completely open: some concepts like voltage and parallel connections were given as optional starting points.

In the pilot TSPCK the first question was phrased as follows:

'What three concepts have you observed that students struggle most to understand. What do you think the reason for this is?'

This item was rephrased to shift the focus off from student levels of understanding to the teacher reflecting on their own practice. In the final TSPCK tool the wording of the question was altered to;

What three electric circuit concepts, in your experience, are the most difficult to present effectively to students and what do you think the reason for this is?

An addition to the type of question in the Mavhunga and Rollnick (2013) tool; there was a question on terminology and language usage in electric circuits. The reason for this is that electricity is part of everyday life and phrases, like ‘*charging my phone*’ or ‘*my battery has run out*’ are part of common language usage. However, in terms of the physics definitions these phrases are incorrect, and become potential stumbling points for students’ understanding. This item is shown in Figure 21. This problem is not found in every science topic, but it was considered an important component of teaching electric circuits generally; hence its inclusion in both the pilot and final TSPCK tools.

C2. Physics terminology is quite precise, and presents difficulties for students. Which two terms in circuits pose the most difficulty for students and please give a reason for your selection

Term 1	Reason:
Term 2	Reason:

Figure 21: Item relating to terminology in Category C

Category D - Representations and analogies

In this category, teachers were provided with a number of representations and analogies and asked to comment on which they liked and which they did not, together with their reasons. They were also asked how they would use the particular representation in their practice. The type of representations given in the pilot TSPCK tool included diagrams, role-plays, stories, diagrammatic analogies and models. In the pilot TSPCK tool two topics were covered, namely current flow in parallel connection and the circuit as a system integrating voltage, current and resistance. The participants

in the pilot process commented that this question, in particular, was time-consuming because of the amount of reading required. Responding to this, the representation and only the analogies relating to current flow in parallel connections were retained in the final TSPCK tool, while the circuit system analogies were excluded. The representations that were retained are shown in Figure 22. below.

D1. Below are three possible representations for teaching the concept of current in a parallel connection. Complete the table below by describing what you like and dislike about each representation and why one representation is better than another.

Representation 1

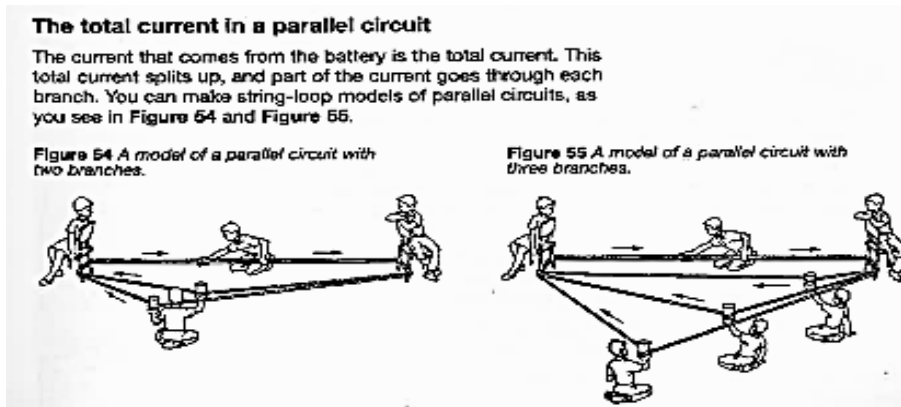

Science for All Grade 9 Learner's Book (Pg. 35)

Representation 2

http://www.windows2universe.org/physical_science/physics/electricity/images/circuit_analogy_water_pipes_sm.jpg

Water Analogy:

- When the water flow (or charge flow) is divided into two or more separate pathways (as in a parallel circuit) the sum of the current in each individual pathway equals the total current. Utilize this principle to fill in the blanks in the following two diagrams. The meters in the diagram are measuring water flow rates in gallons per minute ("gpm").

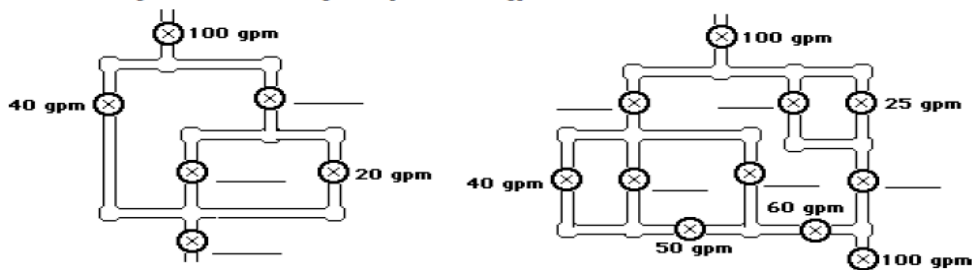

- Apply the same principle to fill in the blanks in the following diagrams for charge flow (i.e., current) through a parallel circuit.

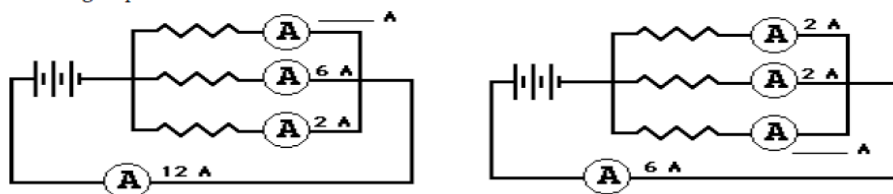
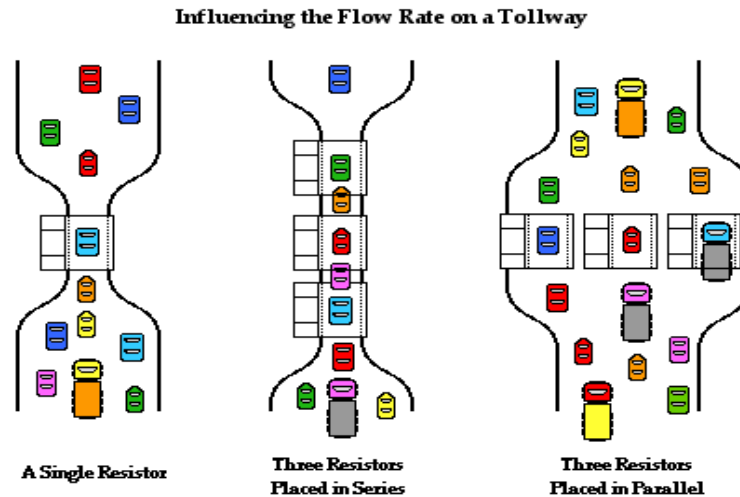

Figure 22: Items retained for Category D in the final TSPCK tool.

Figure 22 Continued:

Representation 3



	What I like and why	What I dislike and why
Representation 1		
Representation 2		
Representation 3		

D2. Which one of above three representations did you like the most and how would you use it in a lesson?

Representation I liked the most	How would you use the representation selected in a lesson?

Category E - Conceptual teaching strategies

This question was unaltered from the pilot to the final TSPCK tool because it met all the necessary criteria of including components of the Categories A to D. This item was given as an example in Figure 18. The adaption made from Mavhunga and Rollnick TSPCK instrument (2013) was to provide more scaffolds for the teacher response; thus there are three sub-sections to the item in response to a single student.

The question was developed around a class exercise, from a textbook, that made use of an analogy to describe flow of charge and energy transformation. In the exercise the students are asked to explain the analogy and thereby show their conceptual understanding of the processes in an electric circuit. In the TSPCK tool a student's partly correct answers to the exercise are given and the teacher is asked to expand on what concepts they think the student has grasped and which not yet. In addition to this, the teacher is asked what strategies she would employ to deal with the student's conceptual gaps.

5.3.2. Step 5: Distribution of the TSPCK assessment tool

The process of developing the content and TSPCK tools was carefully considered. The content tool drew on existing tests in science education literature, but was adapted to make the tool more time-efficient. The final TSPCK tool was designed using the Mavhunga & Rollnick (2013), model for the developing of electric circuit questions for each category and involved the developing of original items. Through the piloting process and in discussion with the reference team, adjustments were made to make the tool more manageable without diminishing its potential in eliciting various levels of teacher TSPCK. The final TSPCK assessment tool is attached in Appendix A. It was sent out to a wide audience of teachers to complete and 16 completed responses were received. The demographics of this group have been described in Chapter 3.

The responses had to be categorised, to ensure validity, careful consideration had to be given to the design of the TSPCK rubric - described in sub-section 5.4. An example of a completed TSPCK assessment tool is attached in Appendix H.

5.4. Development of the assessment rubric for analysing and measuring the responses to the TSPCK tool

The development of the assessment rubric was a critical component of this study. The assessment rubric had to be reworked to accurately assess teacher response, reasoning and level of TSPCK. Similar assessment rubrics have been designed for other science topics, for example Ndlovu (2014) assessed teacher TSPCK in electrochemistry. However because of the specificity of the topic of electric circuits there was a need to adapt the rubric to assess the responses to the final TSPCK assessment tool.

5.4.1. Step 6: Development of the assessment rubric

The framework for the assessment rubric was designed by Mavhunga and Rollnick (2013). It has 4 level descriptors to describe responses: as limited (1), basic (2), developing (3) and exemplary (4). A set of criteria for each of the 5 categories is described that relate to the particular skill or evidence required for that particular category. Figure 23 is an extract from the original rubric designed by Mavhunga and Rollnick for the category 'Student prior knowledge and misconceptions'. The purpose of this extract is to show the overall structure of the rubric.

	Limited(1)	Basic(2)	Developing (3)	Exemplary(4)
Learner Prior Knowledge including misconceptions	No identification/No acknowledgement/No consideration of student prior knowledge or misconceptions	Identifies misconception or prior Knowledge Provides standardized knowledge as Definition Repeats standard definition with no expansion or with incorrect explanation	Identifies misconception or prior knowledge Provides standardized knowledge as definition Expands and re-phrase explanation correctly	Identifies misconception or prior knowledge Provides standardized knowledge as definition Expands and re-phrases explanation correctly Confronts misconceptions/confirms accurate Understanding

Figure 23: An extract from the Mavhunga and Rollnick TSPCK rubric

Ndlovu (2014) refined the rubric by Mavhunga and Rollnick (2013) to evaluate teacher TSPCK in electrochemistry. Both rubrics were used as reference points for the design of my rubric to assess teacher TSPCK in electric circuits. The design then underwent two validation processes.

First Validation

An adapted rubric of Mavhunga and Rollnick (2013) and of Ndlovu (2013) was used for the first validation process. The rubric was designed to be as broad and generic as possible, as the first validation process was part of an ongoing project to design TSPCK assessment tools for the topics of stoichiometry and acids and bases. Figure 24 is an extract from this first rubric.

	Limited	Basic	Developing	Exemplary
What makes the topic difficult to teach?	- Identifies broad topics without specifying the actual sub-concepts that are problematic. - Reasons not given.	- Identifies specific concepts. - Either provides broad generic reasons or no reasons are provided.	Identifies specific concepts with reasons related to specified prior knowledge of students or common misconceptions.	- Identifies specific concepts with reasons related to prior knowledge or common misconceptions. - Provides reasons linking to specific gate keeping concepts that when not fully understood add to the difficulty of a concept regarded as difficult.

Figure 24: Extract from first generic rubric

A reference group comprising a practicing teacher, an assessment specialist and a science educational researcher was given 3 completed tools to code. It became apparent that it was not possible to categorise the responses relating to electric circuits because the criteria were too broad. There was no inter-rater reliability and the raters struggled to categorise responses.

On reflection, two possible reasons for this emerged: firstly, the wording of the original rubric assessed observed practice and not written responses, and secondly, the ability to move between microscopic and macroscopic scales is important in chemistry, whereas in electric circuits the understanding of terms and inter-relatedness of the concepts was viewed as a more important criterion. The difficulty with the initial coding process serves to highlight the topic-specific nature of the construct being assessed.

Assessment Rubric Re-design

The rubric was therefore redesigned in consultation with my supervisor. The main changes that emerged were (i) changing the wording from assessing observed practice to assessing written responses; (ii) writing criteria that emphasised the use of terminology and the inter-relatedness of concepts in electric circuits; (iii) elements of SOLO taxonomy were used to describe the increasing number of connections between topics (Biggs, 1982). In addition to these changes, examples of the type of responses were included to aid understanding of the criteria.

Figure 25 below is an example of how the criteria were adjusted. The criterion selected relates to how a teacher rates and evaluates a representation. The representations used in the TSPCK tool referred to the explanation of current flow in a parallel connection. The changed criteria are highlighted in blue. The wording was phrased in relation to the use of representation – ‘*Use of*’ implies an action in a class, and not the evaluation of the thinking behind the selection of a particular representation. The additions changes shown in the re-designed rubric are highlighted in yellow, and include the removal of the term ‘macroscopic’. This adjustment allowed the inclusion of evidence of the teacher taking multiple aspects of use into consideration. It also provided, at the exemplary level, a criterion that includes evidence that the teacher is aware of where the representation fails. (Hart, 2008). Examples from teacher responses were also included, and are highlighted in pink.

Extract from original rubric

	Limited	Basic	Developing	Exemplary
Representations	Use of only macroscopic (analogies/material artefacts/demonstrations/laboratory work) representations with no explanation of specific links to concept considered	Use of macroscopic representation and other kinds of representations (visual and/or symbolic) without explanatory notes to make links to aspect(s) of concepts considered	Use of macroscopic representation and other kinds of representations (visual/symbolic/sub-micro) with explanatory notes to make links to aspect(s) of concepts being explained	<ul style="list-style-type: none"> - Use of macroscopic representations and other kinds of representations (visual/symbolic/sub-micro) - Extensive use of visual representation (graphical/pictorial/diagrammatic) representations to enforce the specific aspect(s) of concept being considered. - Presence of explanatory notes linking the different kinds of representations to aspects(s) of concepts being explained

Extract from 2nd rubric

Category D: Representations and	D1 - What I like and dislike about the representations?	Reasons given are incomplete, vague and difficult to follow E.g. <i>I like the first one</i> (Note - criteria to be considered across all three representations)	Reasons for selection limited to a single consideration	Reasons for selection include two levels of consideration e.g. ease of use, effectiveness to confront misconception, learners context	Reasons for selection include multiple considerations Reasons for selection also include possible points for new misconceptions or indicates awareness where analogy fails. Reasons includes appropriate use to explain the interrelatedness of electricity terminology

Figure 25: Extracts from the rubric used in the first validation process and the adaptations made for the second. The particular points of addition and alteration are highlighted in blue and yellow. The addition of verbatim examples are highlighted in pink

In the second validation, the same three tools were given to the same three coders as the first validation process. Where differences occurred there was discussion, and refinements in the understanding of the criteria were made. In the second validation process, the coders were able to reach an 83% agreement with each other, and in no criteria was there more than one category difference. The rubric was then used to score the 16 tools submitted, and the data made available for analysis.

During the scoring process a refinement was made, in consultation with my supervisor, of the criteria relating to the item of "Why do think it is important to teach electric

circuits?” The changes thus made are shown in Figure 26. The discrimination between basic, developing and exemplary was considered insufficiently clear. The adjustment was made to specify that in the Basic level a single reason is given, in the Developing level two, and at the Exemplary level the reasoning includes a conceptual focus. The final rubric is attached in Appendix B.

B3(b) – Why is it important?	Reasons limited to a general statement. One reasons given or gives a general statement such as “ has important applications)	Reasons exclude conceptual considerations such as scaffolding/sequential development of understanding for other topics in the subject. But may include application to everyday life <i>E.g. Electricity is a vital part of everyday life. It is important for students know how circuits works so that they can use electricity safely</i>	Reasons include reference to conceptual considerations such as scaffolding/sequential development of understanding of other topics in the subject (however topics not specified) and application to everyday life <i>E.g. These are systems used in their everyday lives, so it is important to have a basic understanding of how they work and the effects of circuits and it is a key part if the final matric exam</i>	Reasons given include conceptual considerations such as scaffolding/sequential development of understanding for specified other subsequent topics in the subject and application to everyday life and/or intrinsic interest
	Adjustment includes number of reasons		Excluded in adjustment	
B3(b) – Why is it important?	Reasons limited to a general statement One reasons given or gives a general statement such as “ has important applications in ...”	Identifies the importance of a topic related to aspects, application and motivation/interest and gives a reason for one aspect <i>E.g. Electricity is a vital part of everyday life. It is important for students know how circuits works so that they can use electricity safely</i>	Considerations of importance are practical e.g. application and motivation/interest, giving reasons for both aspects <i>E.g. These are systems used in their everyday lives, so it is important to have a basic understanding of how they work and the effects of circuits and it is a key part of the final matric exam</i>	Considerations are conceptual e.g. scaffolding/sequential development of understanding for other subsequent topics <i>E.g. It encourages logical thought, problem solving and offers many different ways to solve problems. I’ve always thought of it like circle geometry in Maths – a more creative and lateral thinking section than the usual algebraic methods</i>

Figure 26: Adjustments made after second validation

After these final adjustments the rubric was considered to be valid and reliable. The final TSPCK assessment rubric is attached in Appendix B

5.4.2. Step 7: Categorising the responses using the rubric

Once the assessment rubric had been finalised, the scoring of the responses was completed. The responses were categorised. Figure 27 is an example of this process.

A sample of three types of response to the question “why is it important to teach electric circuits?” together with the rubric and annotated reasoning explaining why they fall into a particular category are included. The first example (104) uses a relevant aspect of electricity use in the students’ day-to-day lives, and is coded at level 2 (basic). The second example (107) includes considerations of practical application, as part of basic science literacy, and considers topics that build onto to this section, and is coded at level 4 (exemplary). The third example (110) considered only conceptual concerns and the link to mathematics, and was also coded at level 4 (exemplary). This example demonstrates that the rubric allows for a wide variety of types of responses, but is still sensitive enough to discriminate between levels.

	Limited	Basic	Developing	Exemplary
B3 (b) – Why is it important?	<ul style="list-style-type: none"> Reasons limited to a general statement One reasons given or gives a general statement such as “ has important applications in ...” 	<div style="text-align: center;">104</div> <ul style="list-style-type: none"> Identifies the importance as a topic related to aspects, application and motivation/interest and gives a reason for one aspect <i>E.g. Electricity is a vital part of everyday life. It is important for students know how circuits works so that they can use electricity safely</i> 	<ul style="list-style-type: none"> Identifies the importance as a topic related to aspects, application and motivation/interest and gives reasons for both aspects <i>E.g. These are systems used in their everyday lives, so it is important to have a basic understanding of how they work and the effects of circuits and it is a key part of the final matric exam</i> 	<div style="text-align: center;">110</div> <ul style="list-style-type: none"> Reasons given include three considerations, application, motivation and interest and conceptual considerations such as scaffolding/sequential development of understanding for other subsequent topics <div style="text-align: right;">107</div>

Figure 27: Extract from respondent 104, 107 and 110 to illustrate level and variety of answers coded by the assessment rubric

Figure 27. Continued

Extract from respondent 104 – Categorised as basic

B3: Why do you think it is important for students to learn about electric circuits?

Write your response here:

2

They have plenty of experience in using electrical equipment in and around the house. Many are curious about how the equipment work, but are either worried about getting shocked or not worried at all about safety when investigating

Extract from respondent 107 – Categorised as exemplary (4)

B3: Why do you think it is important for students to learn about electric circuits?

Write your response here:

Electric circuits play an important role in modern life. They supply us with energy in our homes, cars, etc. Learners need to understand that energy is the driving force for life, with no energy, no life is possible. Electric circuits is one way of how we have been able to capture the energy in the universe so that it is useful for us (keep us warm, let us cook food, have light, communicate with others, etc.

Knowledge of electric circuits are also needed for further study at school level, e.g in electric motors or generators, and beyond school e.g electrical engineering.

I also think this is general knowledge that the public should have basic scientific literacy for everyone, especially usefulness and importance/need to have electricity, and the dangers of electricity.

Extract from respondent 110 – Categorised as exemplary (4)

B3: Why do you think it is important for students to learn about electric circuits?

Write your response here:

It encourages logical thought, problem solving and offers many different ways to solve a problem.

I've always thought of it like circle geometry in maths - ~~rather~~ a more creative & lateral-thinking section than the usual algebraic methods.

While categorising I became aware that I was slightly over-rating the responses for Category B – Curricular Saliency. I therefore re-coded all the responses and checked for accuracy. The coded values were then available for qualitative and quantitative analysis to determine validity and reliability.

5.2. Conclusion

The development of the final TSPCK assessment tool was a carefully scrutinised process with numerous consultations with subject, research and assessment experts. This increased the construct validity of the TSPCK assessment tool. The development of the assessment rubric was equally rigorous. The categories or scores extracted from the respondents, together with the responses themselves, were now available to determine validity and reliability using quantitative and qualitative methods. This process will be discussed in the next chapter.

Chapter 6 -Validity and Reliability of TSPCK Assessment Tool

In this chapter I discuss the process of determining validity and reliability of the TSPCK assessment tool. This was achieved using quantitative and qualitative methodologies.

6.1. Introduction

The purpose of this study was to design an assessment tool that measures TSPCK in electric circuits and to determine its validity and reliability; hence the discussion of validity and reliability speaks to the heart of the project. In broad terms validity can be seen as the extent to which a measurement or 'score' measures what it was intended to measure and reliability is measure of the probability of achieving similar results with another sample population (Neuman, 2000). The focus of this chapter is to answer this part of the third research question: "how valid and reliable is this TSPCK assessment tool in its present design?"

6.2. Defining construct validity and reliability in relation to the TSPCK assessment tool

There are different types of validity which have a bearing on this project. *Face validity* is the most basic type, and is the validity determined by the judgment of the science community. In the case of this project the reference team helps to fulfil this role (Neuman, 2000). Another type of validity is *content validity*, which is concerned with whether the measurement tool includes the relevant content domain for the construct being measured. (Wagner, Kawulich, & Garner, 2012). In this project the content is clearly described using Loughran's CoRe and the CAPS document. The final type of validity - and perhaps the most relevant to this project - is *construct validity*, defined by Wagner *et al*, (2012) as

‘the extent to which the operationalization of your construct taps into the actual theoretical constructs you are trying to measure’.

In this project the theoretical measure is TSPCK in electric circuits, and the TSPCK assessment tool is the device being used to measure it. How authentically the assessment tool measures TSPCK in electric circuits is thus its construct validity.

Messick (1995) defines construct validity as:

“the overall evaluative judgement of the degree to which empirical evidence and theoretical rationales support the adequacy and appropriateness of interpretations and actions on the basis of test scores or other modes of assessment”.

This definition best fits the processes of this project because it includes the need for empirical and theoretical evidence to determine construct validity. Both empirical and theoretical methods are used to determine validity, which also fits the Mixed-Method methodology described in Chapter 3. The empirical evidence will be gathered using Rasch statistical analysis, and the interpretative argument presented by analysing the responses of the sample population in terms of TSPCK.

Reliability is related to validity, and is discussed in conjunction with the empirical and interpretative arguments. In this project a specific sample population, of Physical Science teachers of more than 2 years’ experience, was sought out. The argument needs to be made whether a different but similar group would achieve similar results.

6.3. Overview of the interpretative and statistical arguments used to determine validity and reliability

Two separate but related arguments for validity and reliability are presented. The two prongs for determining validity and reliability are interpretative and statistical. An overview of these two approaches is given in sub-sections 6.3.1 and 6.3.2. A more

detailed statistical analysis is presented in section 6.4., and the interpretive analysis in section 6.5.

6.3.1. Interpretative argument for construct validity and reliability

In the theoretical framework described in Chapter 2 the idea was presented that TSPCK is a sub-concept of PCK. It is observable and measurable, and is specific knowledge that a teacher employs to transform content knowledge (in this case of electric circuits) into knowledge accessible to students. In the interpretative argument for validity, evidence for these transformative processes will be looked for in the responses of the sample group and qualitative analyses.

The evidence will be evaluated according to the Five Categories of the Mavhunga and Rollnick (2013) model. In each of these categories evidence will be presented of this transformation. If the assessment tool is valid there should be evidence of different levels of how teachers respond to student misconceptions, how they organise and sequence knowledge, how they determine areas of difficulty to teach, how they use analogies and representations, and, finally, how they combine all these factors into conceptual teaching strategies.

6.3.2. Statistical argument for construct validity and reliability

Empirical validity was determined using the Rasch statistical model. The strength of this model is that it centres on a measure of the extent to which the data records a single construct; in this case TSPCK. Rasch analysis is applied here using the Windows Winstep software version 3.81.0. Rasch analysis converts ordinal scaled data to linear data. This allows for determining a hierarchy of a person's ability in relation to the difficulty of the item. The underlying premise is that there is a higher probability that more respondents will get the easier items correct, or achieve a higher level in these items. The Rasch software generates two indices of fit namely *Infit* and *Outfit*. Linacre (2012) describes the fit statistic as the difference between a person's observed score

and the statistically generated score, calculated from the data; this is then a measure of the person's ability. The *Infit* indices are a measure of the discrepancies between a person's expected performance and observed performance. Easier items should have the higher scores and *vice versa*, and hence a positive correlation between the person's ability and the item difficulty confirms construct validity. The *Outfit* indices measure the items that are slightly outside of a person's ability. It detects when a performance is outside of what is expected. For both these indices a statistical range of -2 to +2 is regarded, by convention, as acceptable, and an indication both of validity and that a single construct is being measured. Reliability indices for person and items are generated. The person reliability index is a measure of the likelihood of the same result if the person were given a different test testing the same construct. The item reliability index indicates the probability of their placement if the same items were given to a different sample. A high item reliability index indicates that there is a good mix of easy and difficult items (Bond and Fox, 2001).

6.4. Analysing the final TSPCK assessment tool for statistical construct validity and reliability

There were three steps in the process of obtaining numerical data: firstly, the design of the instruments, secondly the design of a criteria-based rubric that would code and rank participant responses within levels, and finally the analysis of the coded data (as outlined in the previous chapter).

The final TSPCK was made available to a wide range of teachers and 16 assessment tools were returned. It was administered together with the CK assessment tool. Both tools took approximately 1½ to 2 hours. General comment from the respondents was that they found completing the TSPCK tool challenging, interesting and even fun.

6.4.1. Raw scores for TSPCK assessment tool and summary Rasch analysis

The scoring procedure has been outlined in the previous chapter. The raw scores of TSPCK tools were subjected to a Rasch analysis using Winsteps MINISTEPS. Table 13 below is a summary of the raw scores of the TSPCK per item, together with a category score and an overall TSPCK score. The category scores were determined as an approximate average between all the scores within that category. These values are compared with the Content Tool percentage and the confidence rating of the teacher.

Table 13: Raw data from TSPCK tools per question, CK assessment tool and confidence level percentage.

Code	Category A <i>Student prior knowledge/ mis-conceptions</i>			Category B <i>Curricular Saliency</i>				Category C <i>What is difficult to teach</i>			Category D <i>Representations and Analogies</i>			Category E <i>Conceptual Teaching strategies</i>		Total TSPCK	Content Tool (%)	Confidence Level (%)
	A1	A2	A Total	B1/B2	Map	B3	B Total	C1	C2	C Total	D1	D2	D Total	E1	E Total			
101	1	1	1	1	1	2	1	1	1	1	2	2	2	1	1	2	55	98
102	1	1	1	1	2	1	1	2	1	2	2	2	2	1	1	1	60	99
103	1	1	1	1	1	1	1	2	1	2	2	1	2	1	1	1	70	69
104	2	2	2	2	3	1	2	3	2	3	2	3	3	3	3	3	85	85
105	4	4	4	3	3	4	3	4	4	4	4	3	4	4	4	4	80	75
106	4	2	3	3	1	4	3	4	4	4	3	3	3	3	3	3	90	74
107	4	4	4	4	4	4	4	4	4	4	4	4	4	4	4	4	75	94
108	1	1	1	2	1	1	1	1	1	1	1	1	1	1	1	1	90	75
109	2	1	2	1	2	3	2	3	3	3	3	2	3	2	2	2	90	96
110	2	2	2	3	1	4	3	4	4	4	3	3	3	3	3	3	85	93
111	2	1	2	3	3	3	3	2	3	3	1	1	1	3	3	2	90	88
112	3	2	3	2	1	2	2	2	1	2	2	2	2	1	1	2	90	-
113	4	2	3	4	4	2	4	4	4	4	4	3	4	3	3	3	80	85
114	1	1	1	1	1	2	1	1	2	2	2	3	3	1	1	1	30	59
115	3	3	3	1	2	2	2	1	1	1	2	2	2	2	2	2	55	-
116	4	3	3	3	2	3	3	3	3	3	2	3	3	3	3	3	100	
Average																2,3	80	84

From this raw data it can be seen that the average TSPCK score was 2,3 which places the majority of this sample in the developing category. The teachers generally performed well in the CK assessment tool – an average of 80%. These two scores show that good content knowledge does not necessarily translate into good TSPCK scores.

Some of these results caused concern. Respondent 108 performed well in the CK assessment, but left large amounts unanswered in the TSPCK assessment tool. A possible reason for this is that the time required to complete the TSPCK was too overwhelming. It is possible that this respondent does have better TSPCK but the evidence provided was categorised and included in the sample. Respondent 114 performed poorly in the CK assessment tool (30%) and I was concerned whether she would have an acceptable level of content knowledge to work with. In the TSPCK there was evidence that this respondent did transform some of the topics, even if this was done at a basic level. It was also decided to retain this data in the sample. While there were concerns about these two data sets, the risk of reducing an already small sample was greater than the concerns raised.

6.5. Validity and reliability statistics of the Rasch analysis

The data was subjected to analysis. The validity is determined by the fit statistics and the reliability by the person and item reliability indices. These two components are discussed in sub-sections 6.5.1, 6.5.2. and 6.5.3.

6.5.1. Interpreting validity of TSPCK assessment with Rasch analysis

Table 14 is a summary of the person statistics for this sample population. It ranks the respondents from highest to lowest ability. The respondent numbers are in the far right column. The measure column gives a numerical value of the person ability: the more positive the value the higher the ability. The columns that are of interest are the *Infit and Outfit ZSTD* scores, they are statistical measures validity and should ideally fall between a range of -2 and 2. The ZTSD scores are calculated as a t-test, and have a mean value of zero. *Outfit* is an outlier-sensitive fit statistic, more sensitive to unexpected behaviour

by persons on items far from the person's measure level. The MNSQ is the mean-square statistic and shows the size of randomness in a sample. MNSQ values usually have an average of 1. Values that are greater than 1 show a high degree of unpredictability and values less than 1 indicate that the sample is too predictable and do not have enough variation in the sample. MNSQ (Mean Square) values are an additional measure for validity and should be below and close to 1 to indicate validity. (www.winsteps.com).

Table 14: Summary of Person measure data

```

17-947WS
TABLE 17.1 TSPCK Analysis          ZOU947WS.TXT  Feb  2 20:47 2015
INPUT: 16 Person 15 Item  REPORTED: 16 Person 15 Item  4 CATS  MINISTEP 3.81.0
-----
Person: REAL SEP.: 3.84  REL.: .94 ... Item: REAL SEP.: .87  REL.: .43
-----
Person STATISTICS:  MEASURE ORDER
  
```

MEASURE	MODEL S.E.	INFIT		OUTFIT		PTMEASURE-A		EXACT OBS%	MATCH EXP%	Person
		MNSQ	ZSTD	MNSQ	ZSTD	CORR.	EXP.			
6.38	1.84	MAXIMUM MEASURE								
3.46	.58	.87	-.2	.76	-.4	.40	.29	73.3	74.3	105 4
2.40	.47	1.48	1.4	1.43	1.3	.39	.34	60.0	59.7	113 4
1.40	.43	1.08	.3	1.02	.2	.80	.37	53.3	58.5	106 4
.88	.41	1.22	.7	1.20	.6	.71	.38	53.3	59.5	110 2
.88	.41	.51	-1.5	.51	-1.5	.26	.38	80.0	59.5	116 4
-.35	.38	.90	-.2	.89	-.2	.13	.41	46.7	51.7	104 2
-.63	.37	.46	-2.0	.46	-2.0	.81	.41	66.7	49.6	109 2
-.63	.37	1.83	2.2	1.85	2.2	-.08	.41	20.0	49.6	111 2
-1.34	.38	1.56	1.6	1.72	2.0	-.44	.39	46.7	51.3	115 3
-1.48	.38	.85	-.4	.87	-.3	.23	.39	60.0	51.7	112 3
-2.30	.43	1.06	.3	.96	.0	.57	.34	73.3	57.0	114 1
-2.71	.47	.62	-1.0	.80	-.4	.41	.31	80.0	65.1	102 1
-3.23	.55	.80	-.3	.68	-.5	.38	.26	66.7	74.5	101 1
-3.23	.55	.56	-1.0	.46	-1.1	.69	.26	80.0	74.5	103 1
-4.78	1.02	1.07	.4	1.82	1.0	-.20	.14	93.3	93.4	108 1
-.33	.57	.99	.0	1.03	.1			63.6	62.0	
2.76	.36	.39	1.1	.46	1.1			17.5	12.0	

This initial data indicates that this sample group of teachers found the TSPCK assessment tool manageable, as indicated by the measure mean of -0.33. The more negative the value the more difficult the person found the assessment to be, while a more positive result indicates that the person found the assessment less difficult. There is an initial indication that the assessment is valid because the majority ZSTD scores for both *Infit* and *Outfit* are within the range of -2 and +2, with the exception of respondent 111, who has a ZSTD score of 2.2. The mean square (MNSQ) value is an additional statistical measure of validity. A MNSQ value of near to one is an additional measure of validity. The average MNSQ value is less than one, at 0.99 and 1.03. Eight of the respondents have MNSQ values below 1, and 8 have values just above 1, with all less than 2.

The fact that all, but one ZSTD data point, falls within -2 and 2 range and the MNSQ values are all near 1 is an indication that the data works together to measure a single construct. From this data there are initial indications that the data is valid but will need the interpretative argument for validity to strengthen this claim.

An additional visual data presentation is the Bubble plot, shown in Figure 28. below. The blue bubbles represent the person measures, and the pink bubbles the item measures. The key visual information to see if the person and item data falls between -2 and +2, on the horizontal axis. The spread along the vertical axis indicates different abilities or difficulties. The Person measure is well-spread between high (+ range) and low ability (- range).

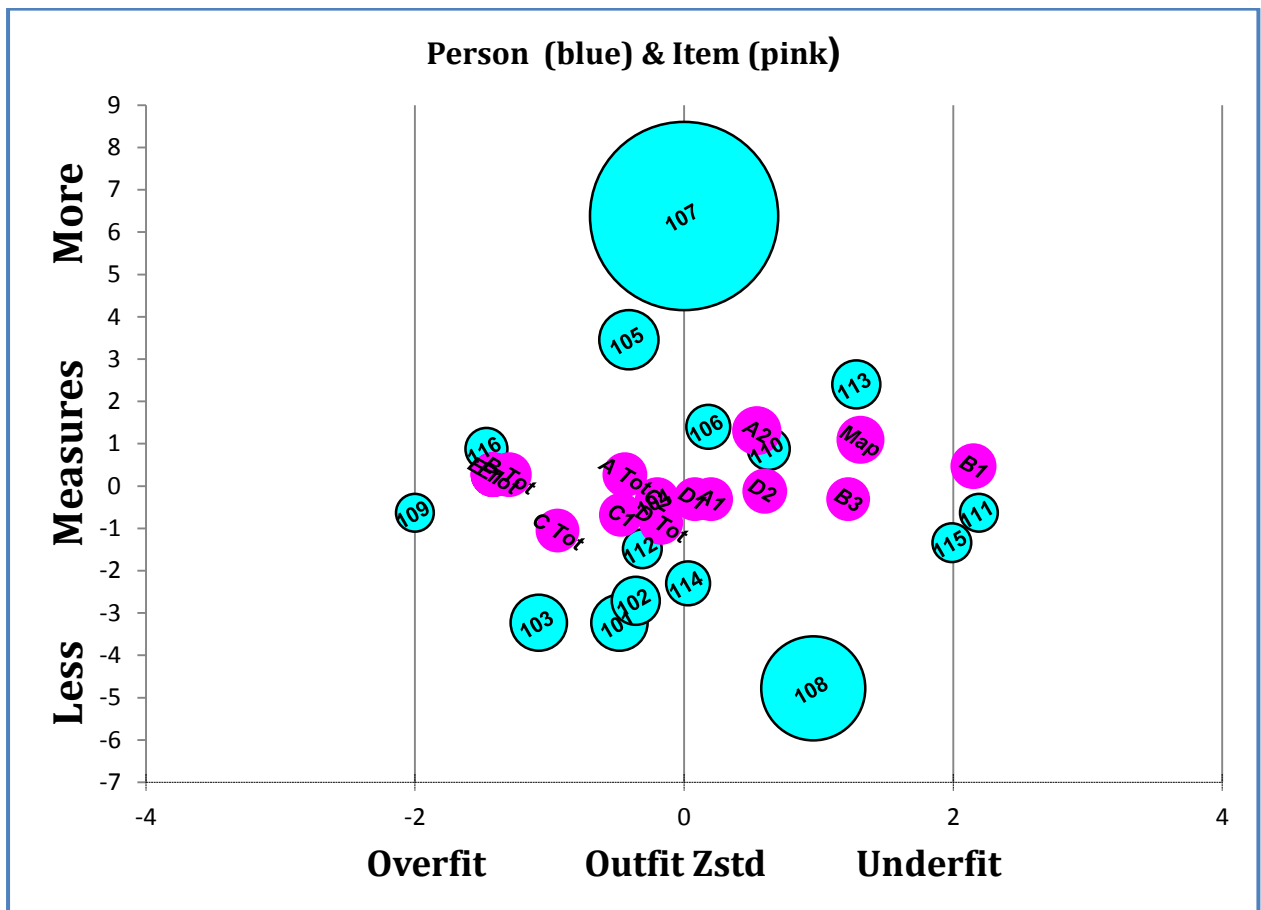

Figure 28: Rasch bubble plot for persons and items.

The majority of this data fall within the -2 and +2 range for persons and items, with some data points marginally beyond these limits. Respondent 111 just falls outside the +2 limit and item B1 also falls outside this range. This indicates that this person and item are a poor fit to the sample. The items do not have a wide spread along the vertical axis, which indicates that there is not a spread of difficult and easy items. An additional piece of information the Bubble Plot gives is in reference to the relative size of the bubbles. The larger the bubble the less reliable the position; on this plot only the top TSPCK respondent 107 has a relatively large bubble size.

6.5.2. Reliability of the TSPCK assessment tool

The second component of the Rasch analysis is the reliability index. Reliability is a measure of the probability of getting similar results with this sample population, and also the probability of getting similar results with these items with a different but similar group of people. The closer this value is to 1, the higher the level of reliability. Rasch analysis also calculates the *Person raw score-to-measure correlation* which is the Pearson correlation between raw scores and measures, including extreme scores, this value should tend to 1. The *Cronbach Alpha (KR-20) Person Raw Score "Test" Reliability* is the conventional "test" reliability index. It reports approximate test reliability based on the raw scores of this sample. It is only reported for complete data. Any value above 0.5 is seen as a good indication of reliability. According to the www.winsteps.com online manual, the Rasch indices for reliability tends to underestimate reliability and the Cronbach Alpha score tends to overestimate reliability. PERSON RAW SCORE-TO-MEASURE CORRELATION is the Pearson correlation between raw scores and measures, including extreme scores. When data are complete, this correlation is expected to be near 1.0. The separation values is used to classify people according to ability a value less than 2 indicates that the assessment may not be sensitive enough to distinguish between high and low performers (www.winstep.com). A summary of the reliability results for the TSPCK assessment tool are given below in Table 15 below.

Table 15: Summary of the Rasch reliability analysis for Persons

SUMMARY OF 16 MEASURED (EXTREME AND NON-EXTREME) Person								
	TOTAL SCORE	COUNT	MEASURE	MODEL ERROR	INFIT		OUTFIT	
					MNSQ	ZSTD	MNSQ	ZSTD
MEAN	35.1	15.0	-.33	.57				
S.D.	13.6	.0	2.76	.36				
MAX.	60.0	15.0	6.38	1.84				
MIN.	16.0	15.0	-4.78	.37				
REAL RMSE	.69	TRUE SD	2.67	SEPARATION	3.84	Person RELIABILITY	.94	
MODEL RMSE	.67	TRUE SD	2.67	SEPARATION	3.96	Person RELIABILITY	.94	
S.E. OF Person MEAN = .71								
Person RAW SCORE-TO-MEASURE CORRELATION = .98								
CRONBACH ALPHA (KR-20) Person RAW SCORE "TEST" RELIABILITY = .97								

The key values in this table are the person reliability. The person reliability value is 0.94, which indicates a high level of reliability within the sample group. The Rasch analysis calculates an additional statistical value of reliability, that of the Cronbach alpha (KR-20) value. The Kr-20 value as calculated by the analysis is 0.97. The value of 0.97 indicates a high level of reliability. Any value above 0.5 is seen as a good indication of reliability. The value of 0.97 indicates a high level of reliability. The separation value of 3.84, above two, indicates that the assessment tool is sensitive enough to distinguish between high and low performers.

This data confirms that this sample population is a reliable sample. If this sample was given a similar assessment it is probable that similar results would be achieved. There is not the same level of certainty for item reliability.

Table 16 provides a summary of the Rasch analysis for item reliability.

Table 16: Summary of Rasch reliability analysis for Items

Person RAW SCORE-TO-MEASURE CORRELATION = .98
 CRONBACH ALPHA (KR-20) Person RAW SCORE "TEST" RELIABILITY = .97

SUMMARY OF 15 MEASURED (NON-EXTREME) Item								
	TOTAL SCORE	COUNT	MEASURE	MODEL ERROR	INFIT		OUTFIT	
					MNSQ	ZSTD	MNSQ	ZSTD
MEAN	37.5	16.0	.00	.44	1.03	.0	1.03	.0
S.D.	3.3	.0	.64	.01	.46	1.1	.55	1.0
MAX.	43.0	16.0	1.31	.48	2.30	2.6	2.41	2.2
MIN.	31.0	16.0	-1.05	.43	.43	-1.8	.41	-1.4
REAL RMSE	.48	TRUE SD	.42	SEPARATION	.87	Item RELIABILITY	.43	
MODEL RMSE	.44	TRUE SD	.46	SEPARATION	1.04	Item RELIABILITY	.52	
S.E. OF Item MEAN = .17								

The item reliability of 0.43 is not as convincing. This value is quite low, and indicates that there is not enough separation in the difficulty of items in the TSPCK assessment tool. The item separation value is small (0.87), which is the statistical measure of range of difficulty. The reason for the lower level of item reliability needs to be investigated further. An immediate possible reason is the sample size. Sixteen respondents is not a large sample, and may not be big enough to establish the variation between difficult and easy items.

Using the Rasch statistical analysis it is possible to map the item separation, in other words, which items are statistically more difficult than others. This is potentially useful information because it is possible in the qualitative analysis to examine the responses and discern the reasons why certain items are more difficult than others. This creates a triangulation of data and will lend credibility to the statistical data, even where there is some weaker than expected results in the analysis.

It is important to look at the items in terms of relative statistical difficulty. This information will then guide the qualitative analysis of the TSPCK responses, which will be discussed in Section 6.6.

Table 17 is the item within the TSPCK broad categories. The more positive the value, the greater the difficulty is seen to be. Table 18 gives the item separation per individual item. This information is potentially useful because it relates to specific content areas. This data can become a point of intersection between the prevalent misconceptions identified in the CK assessment tool and the interpretative analysis that follows in the next section.

Table 17: Item measure by Category ranked from most difficult to easiest

TSPCK Category	<i>Category A Prior learning and misconceptions</i>	<i>Category B Curricular Saliency</i>	<i>Category E Conceptual teaching strategies</i>	<i>Category D Representations and analogies</i>	<i>Category C What is difficult to teach</i>
Item measure	0.27	0.27	0.27	-0.87	-1.05

The item measures give a statistical value of the relative difficulty of items, the more positive the value the more difficult. From this data it can be seen that no one category was found to be significantly more difficult than another, Categories A, B and E scoring at the same level of 0.27. The easiest was Category C. These results are different from the Mavhunga and Rollnick and the Ndlovu TSPCK instrument, where Category E was the most difficult item because it involved the bringing together of all the components of categories A to D. The average difficulty level was calculated at 0.0 indicating that this group managed the assessment tool was relative ease. These values are not significantly different from each other. The values also indicate that this sample did not experience to items as overly difficult but there also no items that were particularly easy either.

Within this data there is little separation between Categories. When the items are viewed separately in Table 18, a more detailed and useful pattern of item variation emerges. The item measure, again gives a statistical measure of relative difficulty of items.

Table 18: Item measure by individual items ranked from most difficult to easiest

	A2	Map	B1/2	B3	E1	D2	A1	D1	C2	C1
Content covered	Total Resistance drops when a resistor is added in parallel	Inter-relatedness of concepts and terms in electric circuits	The 'Big Ideas' – selecting sequencing important concepts	Why is it important to learn about electric circuits	Conceptual understanding 'Sparky question'	Representation of current flow in parallel circuits	Current is conserved through a series circuits	Representation of current flow in parallel circuits	Potential problems with the use of physics terminologies	The use and understanding of terminology
	1.31	1.09	0.47	0.40	0.27	0.12	-0.31	-0.31	-0.31	-0.68

In this table the variation of items within categories becomes more evident, and it is beginning to appear that content plays a significant role in item difficulty. The item A2 referring to the effect of on current with the addition of a resistor in parallel is the most difficult. In the same category, a similarly structured item (A1) but covering different content was one of the easiest items with a -0.31. The concept map item had the second

highest difficulty measure. The items dealing with use of terminology were relatively easy to define and detect. However, when terminologies had to be ranked and the interconnections between the terms explored, this proved to be more difficult. The respondents had difficulty selecting what the main 'Big Ideas' were (B1/2) and then the subsequent step developing these ideas into a concept map is made more difficult. This correlates broadly with the sites of misconceptions detected in the CK assessment tool.

As a summary of the item and person measures, a Person-item map is given in Figure 29. The vertical axis ranks the ability or difficulty. The persons are plotted to the left and the items to rank. This 'map' gives a picture of the scaling of the persons relative to the items.

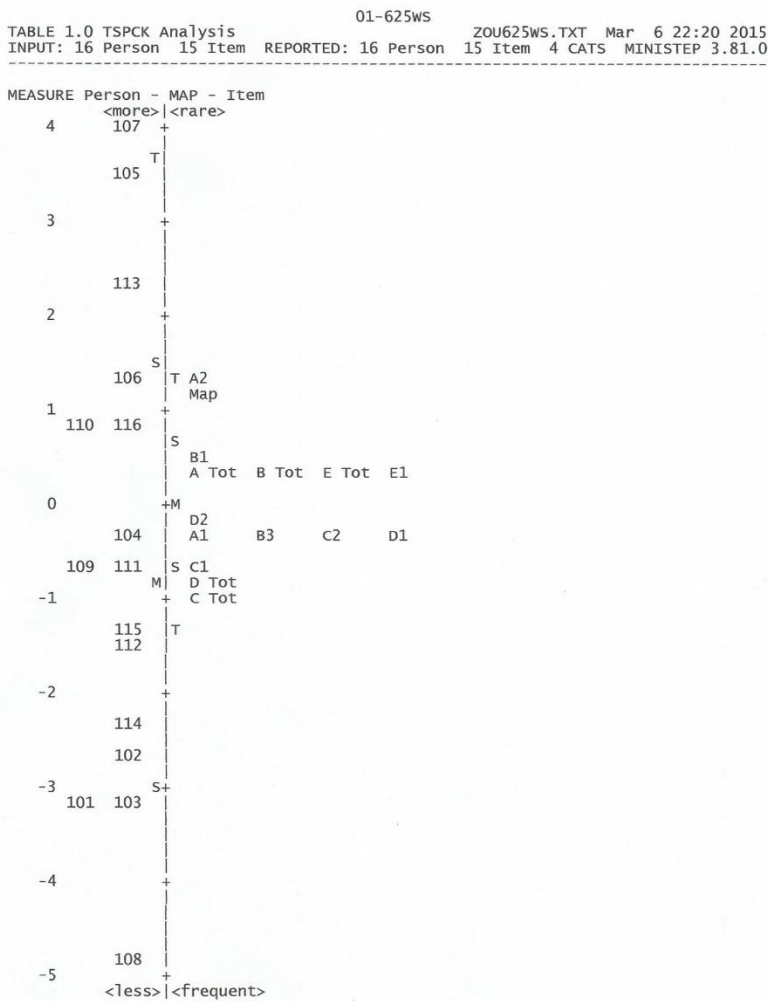

Figure 29: Person-Item map for the TSPCK assessment tool

Figure 29 shows that the population is widely spread in ability. This spread is different from the data generated from the CK assessment tool, which had the person measure clustered more to the top of the scale. The Item measures for the TSPCK assessment tool are grouped in the middle which is also different to the CK assessment tool items which were grouped on the lower end. This shows assessment tools did not test in the same way despite covering the same content and being completed by the same sample population. The relationship between the CK and TSPCK assessment tools will be discussed more fully in section 6.7.

6.5.3. Conclusion of statistical argument for validity and reliability

A statistical argument for the validity and reliability of the TSPCK assessment tool has been presented. There is good evidence that the TSPCK meets the requirements for statistical validity but the evidence for reliability is not as strong. The argument for statistical reliability, while not as strong as the validity argument, is not so weak that does not meet any of the criteria for reliability. There is enough indication that with a larger sample the requirements for reliability would be met. The quantitative analysis also point to the topics that are more difficult for teachers to transform knowledge.

The key finding from the statistical analysis is that the TSPCK assessment tool does work together to measure a single construct. However, the quantitative argument is not viewed in isolation and an interpretative argument for validity and reliability is also presented.

6.6. Interpretative argument for validity and reliability

If the TSPCK assessment tool is a valid means to rank levels of reasoning with regard to TSPCK there should be evidence of this in the teacher responses. Qualitative analysis of teacher responses should provide evidence why one item is more difficult than another and triangulate with the item measure statistics discussed in the previous section, even if this difference in item difficulty is statistically quite small. In the qualitative analysis it should be possible to link the data from the CK assessment tool. If the scores and

confidence levels from the CK assessment tool indicate the possibility a teacher held a misconception this, should also be evident in the teacher responses.

In the next section examples from each category will be presented with comments relating to the evidence of teacher reasoning. The purpose is to show the ability of the TSPCK assessment tool to draw out different types and levels of reasoning. Three categories have been selected as examples of the type of analysis possible. Category A- *Student prior knowledge and misconceptions*- was selected as an example because it presented evidence that misconception presented in the CK assessment test persist into the TSPCK responses. Item A2 was statistically determined to be the most difficult item. The concept map was selected from Category B - *Curricular saliency* - because it was statistically evaluated as the second most difficult item. It illustrates the complexity of the concepts a teacher needs to order and connect to teach electric circuits. The final category selected is Category E - *Conceptual teaching strategies* - this category brings together all the other components of TSPCK reasoning and theoretically should be the most difficult category. Category C and D were not included because the interpretative analysis in these categories is very similar to Category A and B. They were also the categories that were determined to be the easier items and the evidence from the interpretative analysis was not as varied as the evidence from Category A, B and E.

6.6.1. Category A - Prior knowledge and misconceptions

In Category A there were two items: one that dealt with current being constant throughout a series circuit and the second item dealt with the impact of current and resistance when a resistor is added in parallel. In the CK assessment tool construction of parallel connections was identified as one of the sites of misconceptions within the teacher group. Figure 30 is a copy of the item in the TSPCK assessment tool. Two extracts were selected as an example of the analysis and are shown in Figure 31.

A2. How would you respond verbally to a student who answers B to the following question?

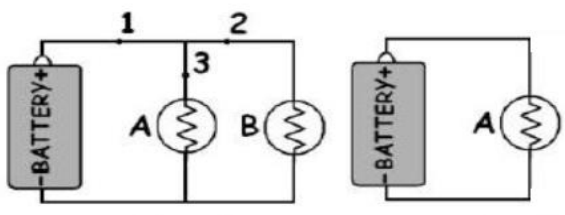

Figure 6 **Figure 7**

Compare the brightness of Bulb A in Figures 6 and 7.

- A. Brighter in Figure 6
- B. Brighter in Figure 7
- C. The same in the both figures

Response A: Just because there are two light bulbs in figure 6, doesn't mean that A will burn brighter. The brightness is dependent on the amount of current moving through the bulb. In Figure 6 the current has been divided at the parallel connection. The presence of the parallel connection means resistance is halved so current is doubled so the amount of current through the parallel branches, in this case, is the same as through the single bulb so there is no difference in brightness.

Response B: All the bulbs are identical; their brightness is dependent on how efficiently they can transform energy, which is defined by the term power. In electric circuits power can be calculated by $P = VI$. In the parallel connection if we calculate the equivalent resistance of the parallel connection. If we assume a resistance of 2Ω then $\frac{1}{R_T} = \frac{1}{2} + \frac{1}{2}$ which is equal to 1Ω exactly half the overall resistance in Figure 7. Seeing that as voltage stays the same current would be doubled and then halved again at the parallel connection, so the same amount of current is available to be transformed.

Response C: You seem to have missed that the bulbs in figure 6 are connected in parallel. At the parallel connection the current divides. The bulbs have identical resistance so the current will divide equally through both branches. Two bulbs in parallel halves the resistance, which doubles the current, which is then halved again at the parallel connection, so the net effect is zero and bulbs will burn equally bright.

Response D: None of the above

Figure 30: Item selected as an example for the qualitative analysis of a Category A

Respondent 107 got all the questions relating to parallel circuits correct in the CK assessment tool. The next respondent – 102, got 3 questions relating to parallel circuits incorrect in the CK assessment tool and in all these questions stated that she was confident about her answer. These two respondents were selected as examples because they represent two extremes. The analysis is given in Figure 31

Respondent 102 – Coded as Limited

My choice is C

My reason is _____

But not the complete reason, I would explain series and parallel effects on current in circuit then explain how brightness depends on power and $P=IV$ so if $I \downarrow$ then in parallel the bulbs are dimmer

There was evidence of misconception in CK assessment tool and this persists in this explanation. The teacher has missed that the current and brightness through the parallel branch in this situation remains the same and gives the incorrect answer.

There is evidence in this response of some content knowledge but conceptual understanding is missing

Coded as Limited - 1

Respondent 107 Coded as Exemplary

My choice is B

My reason is _____

Learners really struggle with questions like these. In an answer like C about halving and doubling and halving again, many learners do not follow your explanation. I think the switch between words and symbols and diagrams all the time is really difficult. In my experience, working with numbers, by putting real values into the circuit, helps learners make it more concrete. Possibly also because one is only working with symbols, so it is easier. I have therefore chosen B. It also brings in power, which is needed to explain brightness. A and C does not talk about power, only R and I.

Teacher shows an understanding of her students. Understands where students struggle

She demonstrates where students have conceptual difficulties

Gives reason for selecting B relating to learner ability

Gives reason for excluding other possibilities

Coded as Exemplary - 4

Figure 31: Item A2 and example of the type of responses, extracted from respondents 102 and 107

There is evidence that the misconceptions about parallel connections persist in Respondent 102 responses in the TSPCK assessment tool. Respondent 102 uses the power formula ($P = VI$) to argue that the bulb will glow dimmer because the overall current decreases. This answer does not take into account that the overall resistance will drop when an additional bulb is added in parallel. What is interesting to note is that the options provided were all conceptually correct, the respondent selected an option that she liked the best and argued for it using the incorrect explanation, illustrating how persistent a misconception can be.

The above Figure 31 is an example of the type of analysis possible with this item. Evidence from respondent 102 shows that the misconception persisted and conceptual gaps were exposed in her response to the TSPCK assessment tool. Evidence from respondent 107 shows the type of multilevel reasoning required to select a response is shown. This item was statistically the most difficult item. The idea that current doubles because of the resistor in parallel and then halves again at the parallel junction is confusing for both teachers and learners and a difficult concept to explain. It requires conceptual understanding of current, resistance and voltage. This inter-relatedness of concepts in electric is one of the conceptual difficult parts of electric circuits and this item requires understanding of multiple concepts and their interaction which is a possible reason why it was ranked as a difficult item.

6.6.2. Category B – Curricular Saliency

Curricular Saliency had the widest range of item difficulty within one category. The concept map was the second most difficult item (1.09), the selection and sequencing of the “Big Ideas” the third most difficult (0.47) and the reasons why it is important to teach electric circuits was the least problematic. (0.4).

In this category a list of main and subordinate ideas were given and the respondents had to select the main concepts and sequence the order in which they would teach the

concepts. Sequence is difficult to determine in electric circuits because terms and concepts overlap and inter-connect rather than follow sequentially, which is a possible reason why this category proved difficult. Half the respondents did not attempt the concept map, some wrote a paragraph and one person copied a diagram from a computer animation. The concept map was the most complex item in the TSPCK assessment tool. Figure 32 gives the list of main ideas and sub-ordinate ideas, as a point of reference, given in this category, the topics highlighted in yellow are the “Big Idea”. Selecting the ‘Big Ideas’ is essential to developing the concept map. The concept maps are attached in Figure 33 and examples of the analysis is shown.

A selection of content and concepts relating to electric circuits is provided. The question below refers to how knowledge and concepts are ranked and how a teacher makes connections between content and concepts.

B1. Review the list of concepts relating to electric circuits below.

Select and rank three foundational concepts, that you regard, as both basic and central concepts in electric circuits.

- To obtain an electric current there needs to be a continuous loop from one battery terminal to the other terminal**
- An electric current is the net flow of charge.**
- Parallel connection in a circuit are current dividers
- The materials that make up the circuit provide the charged particles when there is an electric current
- A battery provides the energy for an electric current**
- Voltage can be defined as $J.C^{-1}$
- Ohm's law can be expressed as $V = \frac{R}{I}$
- When there is a current, energy flows from the battery to the external circuit.**
- Resistance is the opposition to current flow
- A battery creates an electric field within the materials that make up the circuit. The electric field is the cause of current flow.**
- The resistance of a parallel connection can be calculated by $\frac{1}{R_T} = \frac{1}{r_1} + \frac{1}{r_2} + \frac{1}{r_3} \dots$
- An electric circuit is a system in which changes in one part can affect other parts**
- Power is the rate at which energy is dissipated by the circuit component.
- Current measured with an ammeter and voltage by a voltmeter

Figure 32: The Category B list of “Big Ideas” and other sub-ordinate ideas for item B1 and 2

Three concept maps have been extracted as examples of the different levels and are shown in Figure 33. Respondent 110 - categorised as limited (1), 107 - categorised as exemplary (4) and 111 - categorised as developing (3)

Concept map from respondent 110 (Categorised as Limited (1))

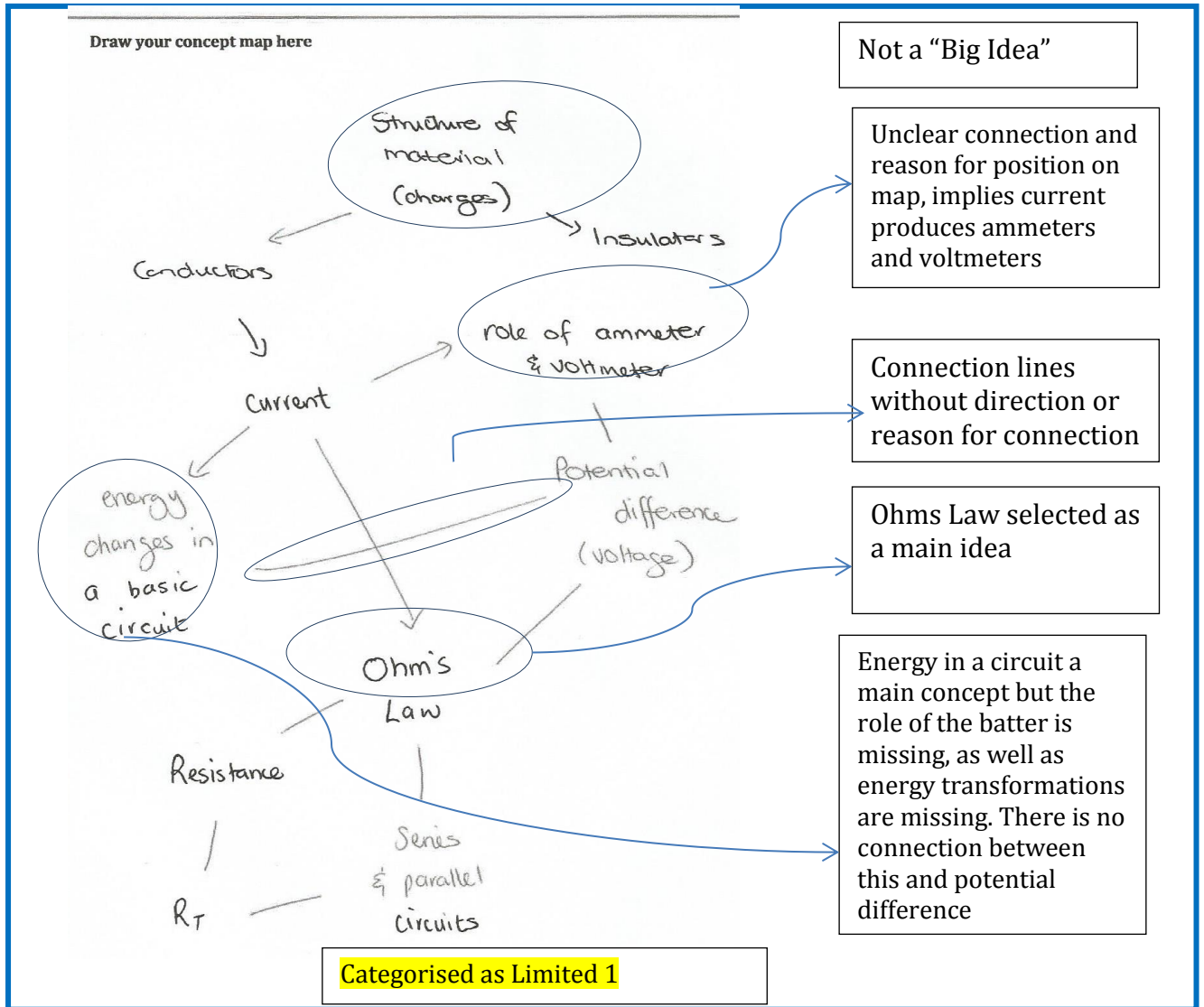

Figure 33: Concept map analysis for respondents 102, 107 and 111

Respondent 110, categorised at level 1 - limited - simply listed terms and connected terms with arrows and no explanation. Ohm's Law was situated in this map as a main idea but there are several concepts that need to be in place before this is covered. It may

be possible that teachers less able to transform the content will revert to focussing on the algorithmic components of this topic without deep understanding of the concepts. The connections between concepts are missing and the role of the battery isn't included, all of these reasons indicate limited TSPCK

Figure 33 Continued:

Concept map from respondent 107- Categorized as exemplary (4)

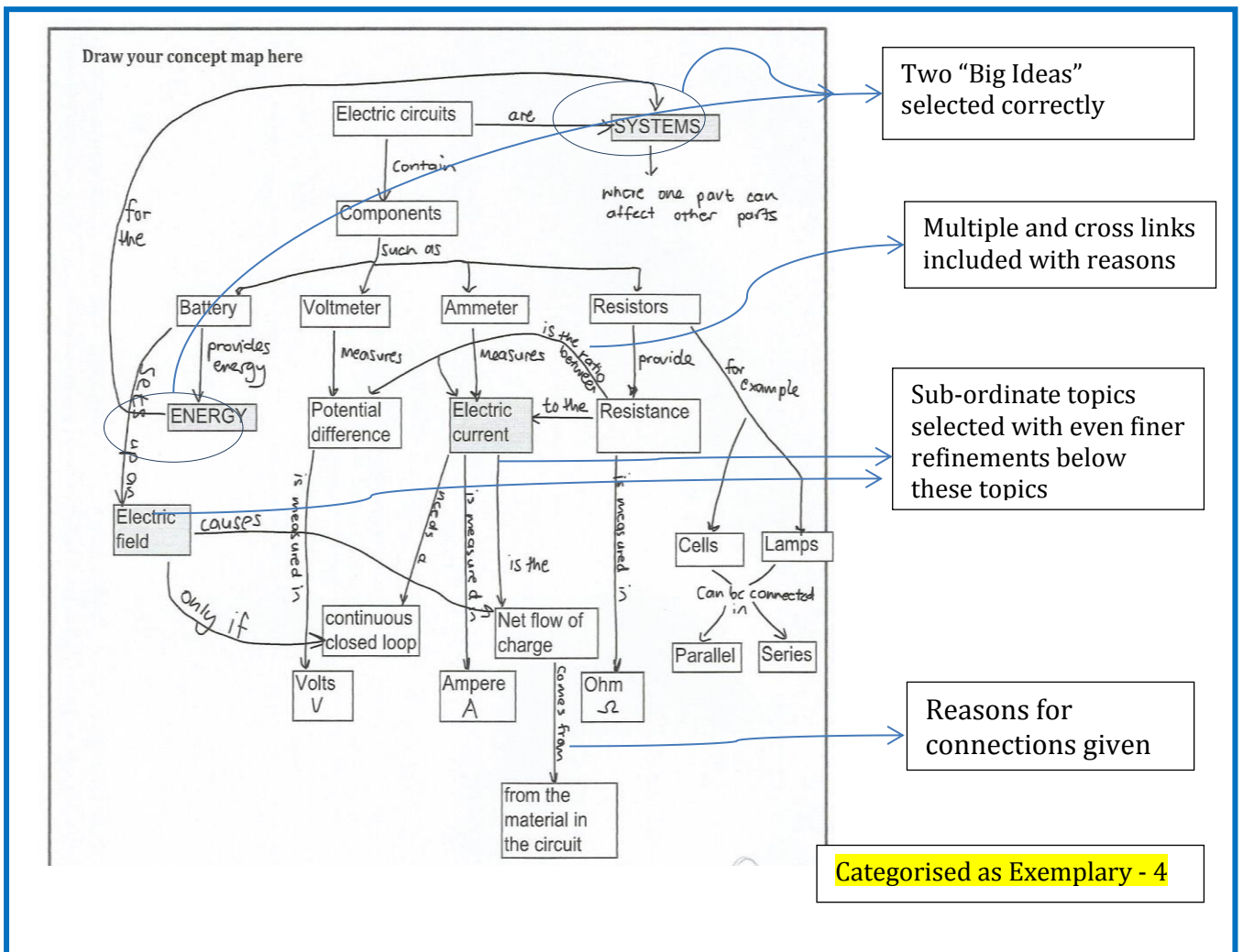

Respondent 107 was categorised at level 4 – exemplary – because her map clearly presented the “Big Ideas” as main headings and had multiple subordinate levels, as well as showing multiple links between concepts.

6.6.3. Category E – Conceptual teaching strategies

In the TSPCK assessment tool designed by Mavhunga & Rollnick, (2013) and Ndlovu (2013) this category was determined to be the most difficult because it brings together all the other categories and requires multi-level reasoning. In this TSPCK assessment tool this is not the case and it was statistically determined to be only of moderate difficulty. A possible reason is that the item was scaffolded, which made it easier for the teachers to organise their thinking. Three examples of the type of responses given are shown in Figure 34. In this Category the teachers were given a students answers to a question about electric circuits. The student gave a mix of correct and incorrect answers showing that he understood some concepts better than others. The teachers were asked to identify the students conceptual gaps and give strategies they would employ to assist this student.

The examples were selected to illustrate the different levels of approach. Respondent 101 identifies 2 conceptual gaps and doesn't articulate a strategy to confront these. Respondent 105 identifies 5 conceptual gaps and clearly articulates two different strategies to confront these.

Extract from Respondent 101 – Categorised as limited (1)

The image shows a handwritten response from Respondent 101. It is divided into two parts: (b) and (c). Part (b) asks for key conceptual gaps, and part (c) asks for specific strategies to bridge these gaps. The response identifies two misconceptions: missing energy required to move charge and confusing energy with charge, and missing energy conversions like chemical to electrical or electrical to light/heat. The strategy proposed is to differentiate between charge, energy, and current. Annotations highlight that two misconceptions are identified and that the strategy is simply rephrasing missing terms. The response is categorized as Limited - 1.

b. What are the key conceptual gaps, in your opinion, that this student demonstrates?

Write your response here

- Missing the "energy" required to move the charge
- Confuses energy with charge.
- Missing energy conversions occur eg chemical to electrical or electrical to light/heat

Identifies 2 misconceptions

c. What specific strategies would you employ to bridge these gaps?

Write your response here

Differentiate between charge, energy and current.

Strategy to confront misconception not in place, simply a re-phrasing of missing terms

Categorised as Limited - 1

Figure 34: Example of responses for Category E from respondents 101 and 105

Figure 34 Continued:

Extract from Respondent.105 – Categorised as exemplary (4)

b. What are the key conceptual gaps, in your opinion, that this student demonstrates?

Write your response here

The learner does not know that electricity results from the flow of charge and that ~~charge~~ this charge consist of particles that move around the circuit. Therefore charge is conserved. As the charge moves energy is ~~disip~~ dissipated as heat in the circuit.

They also do not know that the current remains the same at each point in the circuit.

Identifies 5 areas of misconceptions or

c. What specific strategies would you employ to bridge these gaps? 107

Write your response here

Use of the traffic analogy (petrol as source of energy) cars as particles that move) to show that the number of cars going from point A to B does not change, but then set up a simple circuit with an ammeter to measure current at different points in the circuit.

Multiple strategies selected

Use of analogy

Use of a hands-on practical to specifically address one of the misconceptions

Categorised as Exemplary- 4

The difference between these two response is the level of awareness of the type misconceptions held by students and the number of potential conceptual strategies each

teacher is able to articulate. The purpose of the TSPCK assessment tool is to extract different levels of teacher reasoning and these two responses show a distinct difference in reasoning that is distinct from content knowledge.

6.6.4. Conclusion of interpretative argument

The purpose of the interpretative argument is to show that the items in the TSPCK are useful to extract teacher reasoning. The variation of the answers shows that it is possible to rank answers. The careful development of the assessment rubric has been vital in defining and clarifying the criteria for the different levels. Teaching is a complex activity and a statistical score can mask this complexity. The qualitative analysis allows for consideration of the individual and how they approach their teaching. Validity is a measure of the extent to which an assessment measures what it was intended for and this assessment tool does distinguish between different levels of reasoning. The reliability is achieved by having a clear and descriptive rubric, which generates similar categorising with different raters. The inter-rater agreement was 83%, indicating a good level of reliability. The interpretive argument for validity and reliability is strong.

6.7. Relationship between TSPCK and CK assessment tools

The correlation between the CK and TSPCK scores is an important component of this project. The relationship was determined using the Pearson product-moment correlation coefficient. The final scores of the TSPCK and the CK assessment score were used as overall correlation, with the statistical significance set at $p < 0.01$. A correlation value lies between -1 and +1 and the more linear the relationship the nearer the value will be to -1 or to +1. If the value falls between 0.66 and 0.85, this indicates a good relationship between the dependent and independent variables. If the correlation value falls between 0.35 and 0.65 there is some indication of a linear relationship, but its predictive value is limited (Creswell, 2012).

The calculated Pearson product-moment value is 0.453. This value indicates that there is positive linear relationship but it is of limited predictive value. This value is not completely unexpected because it does not necessarily follow that high CK will result in a high level of TSPCK. Mavhunga and Rollinick (2013) proposed that it through subject knowledge that teachers are able to reason through the 5 Categories of TSPCK. This relationship is confirmed by this sample group. However a strong performance in the CK assessment tool does not necessarily equate to strong TSPCK.

While it is evident from the Pearson correlations that there is some linear relationship between CK and TSPCK, there are other factors that influence the relationship. Factors that could influence the relationship include recent familiarity with the topic and the length of time required to complete the TSPCK. The time required to complete the TSPCK tool might have meant that some items were left unanswered. In some cases there was evidence in other items that the teacher did have developing or exemplary TSPCK but these unanswered or incomplete responses were categorised at a level 1, which may not be an accurate assessment of the teachers' ability.

Another way to visualize the positioning of the respondents in relation to their CK and TSPCK levels is to plot them in quadrants, shown in Figure 35. On the x-axis CK is plotted and on the y-axis TSPCK is plotted. The first quadrant is high CK and high TSPCK, the next quadrant shows good CK and low TSPCK, the third is both low CK and TSPCK and the final quadrant shows low CK and good TSPCK. This plot shows that none of the respondents fell into the quadrant low CK high TSPCK.

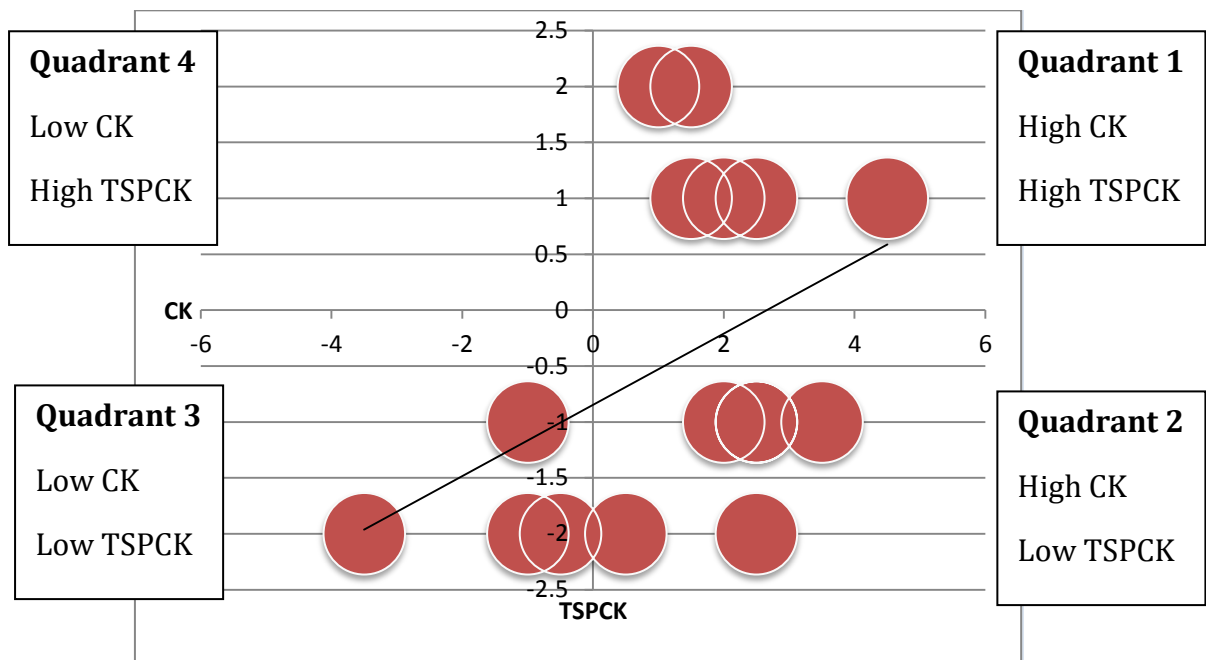

Figure 35: Bubble plot showing relative position in relation to CK and TSPCK

In Quadrant 1 – low CK and high TSPCK there are no plots. In Quadrant 2 – high CK high TSPCK there are 6 respondents that fall into this this category, in Quadrant 3 – Low CK low TSPCK there are 4 respondents within this category and in Quadrant 4 - high CK low TSPCK there are 6 respondents within this category. This relationship follows the theoretical framework presented by Mavhunga and Rollnick (2013).

The relationship between the CK and TSPCK assessment tools can also be seen when the misconceptions found in the CK assessment tool match the items that were most difficult in the TSPCK assessment tool. Parallel misconceptions was found to be one of the most prevalent misconceptions held by the teachers and a similar question in the TSPCK was statistically found to be one of the most difficult. In sub-section 6.6.1. evidence was presented of where a teacher holds a misconception and how it impacts the way she transforms knowledge for her students.

The relationship between CK and TSPCK is present but it is multifaceted. The one clear relationship is that without content knowledge it is not possibility to demonstrate the

reasoning required for TSPCK. The converse relationship is not a clear. Good content knowledge does not automatically mean that ability to demonstrate TSPCK reasoning exists. The respondents in the highest TSPCK category did not achieve the highest CK scores but they did have good CK levels.

6.8. Conclusion

Both an interpretative and quantitative evidence for validity have been presented. The qualitative argument for validity is that for both persons and items the Rasch score for the majority of the data falls within the range of -2 to +2. The person reliability is good at 0.94 but the item reliability is relatively low at 0.43. This could be attributed to the small sample size. The correlating statistical of the Cronbach-Alpha (Kr-20) for reliability score is 0.97, indicating that there is some evidence of reliability and a better reliability score could be achieved with further testing. There is statistical evidence that the items are able to discriminate between different reasoning abilities. The statistical range of difficulty between items is small, which again indicates that a larger sample is required.

The interpretative analysis shows that it is possible to find evidence of teacher reasoning and how they transform knowledge to make it accessible. It is also possible to categorise the way teachers transform content knowledge and assign relative ranks to this process. The task of seeing and measuring TSPCK, while challenging, has been shown to be possible in the interpretive analysis and it is possible to value a value judgement of 'good' or 'bad' TSPCK on the responses.

If the qualitative and quantitative data are taken together the argument for validity and reliability can be made. The quantitative data showed statistical validity. The process of construction and the design of the assessment rubric ensured construct validity. The interpretation of the responses showed that variation and subtlety could be evidenced adding to the argument for validity.

In addition to this the correlation between the CK assessment tool and the TSPCK was investigated. In broad terms it showed that good content knowledge does not automatically equate to good TSPCK reasoning but that with weak CK knowledge it is not possible to have good TSPCK reasoning. The correlation discussion of the two assessment tools shows that CK and TSPCK are two distinct knowledge domains. In the next chapter argument will be presented whether or not this data is sufficient to answer the research questions presented in Chapter 1.

Chapter 7 - Discussion of findings, implication of results and conclusion

This chapter presents an overview of how the project was conducted and discusses findings in relation to the research questions. The implications of the study are given, followed by recommendations, limitations and a final conclusion.

7.1. Introduction

The poor performance of South African Mathematics and Physical Science teachers is well-documented (Dempster, 2007, Selvaratnam, 2011 and Chrisholm, 2009). The PCK research group at the University of Witwatersrand have been investigating the possibility of developing TSPCK as a strategy to improve the quality of in-service and pre-service science teachers. In order to measure 'improvement' there needs to be some form of describable and measureable criteria to make this claim. This has necessitated the need to design assessment tools covering the topics in the South African Physical Science curriculum. There were two equally important starting points or foundations for this study: firstly, the nature and type of misconceptions prevalent in electric circuits and secondly the process of describing and measuring TSPCK for electric circuits. These two components interlink because without a teacher having the correct understanding of the concepts involved with electric circuits, she will not be able to transform this knowledge and make it accessible for her students and to confront and remediate the misconceptions held by her students. Two assessment tools were developed: one was adapted from existing tests to assess content knowledge and the other was newly designed to measure TSPCK levels.

Electric circuits were selected because the topic forms a key part of the CAPS curriculum at multiple grade levels. Grade 10 was selected as the content covered at this grade forms the conceptual foundation for grades 11 and 12. The content covered in

grade 10 is indirectly examinable in the Grade 12 year because understanding concepts of current, voltage, resistance, series and parallel connections form the backbone of any electric circuit question. A review of the science education literature reveals that the topic of electric circuits is a common site for misconceptions to exist, both in teachers and students, (Engelhardt & Beichner, 2004, Loughran, et al., 2006, Mulhall, et al., 2001, Pesman & Eryilmaz, 2010, Summers, et al., 1998, Wainwright, 2007 and Tarciso Borges & Gilbert, 2010). These common misconceptions, Loughran's CoRe and the CAPs document provided the content starting point for the development of both the CK and TSPCK tools.

7.1.1. Methodology Overview

The Mixed-Method (MM) approach was used to answer the research questions. Both quantitative and qualitative processes were used during the development of the two assessment tools and in determining the validity and reliability of these tools. There was strong emphasis on the processes followed during the development of the two assessment tools, making it possible to describe this research as methodological. A pragmatic philosophical orientation was adopted in this project. The advantage of using a Mixed-Method methodology is that it brings the best attributes of both qualitative and quantitative methods to the analysis namely; the measurable certainty of empirical data and the expression of the complexity of reasoning that is possible with an interpretative approach (Burke Johnson & Onwuegbuzie, 2004).

Development of CK and TSPCK assessment tools

Two assessment tools were adapted or newly designed. The CK assessment tool was adapted from existing tests in literature. The final CK assessment tool consists of 20 multiple-choice items, together with a confidence rating for each question. The purpose of the assessment tool is to measure the content knowledge level of the respondents and to detect possible sites of misconceptions. The TSPCK assessment tool consists of 9 open-ended items designed to extract teacher reasoning about teaching electric circuits.

The items were designed using the structure of the Mavhunga and Rollnick (2013) TSPCK model, which defines the process transforming of content knowledge using 5 categories; namely (i) learner prior knowledge and misconceptions, (ii) curriculum saliency, (iii) what is difficult to teach, (iv) representations and analogies and (v) conceptual teaching strategies.

The development of both assessment tools was a rigorous process and involved processes of discussions with subject and assessment experts, piloting and re-design. Careful attention was given during the design process that the assessment tools were understandable and accessible for the respondents but without losing the depth of response required to measure TSPCK. Both assessment tools were made widely available but the response rate was low, with a final sample size of 16 respondents collected.

Data Collection

The 16 completed assessment tools were collected and scored. The CK assessment tool was scored using a memorandum. The responses to the TSPCK assessment tool were categorised using an assessment rubric. The rubric was re-worked multiple times to ensure that it accurately categories teacher responses. Writing the descriptors entailed looking for patterns and ways to describe the responses that were specific enough to categorise TSPCK level but broad enough to allow for the varied responses expected. When the final rubric was validated an 83% agreement was achieved between 3 raters. The key aim of the categorising process was to rank levels of reasoning of the teachers to authentic teaching situations, within the topic of electric circuits.

Validation and Reliability of the CK and TSPCK assessment tools

The data collected was analysed in two parts, statistically and interpretatively. The raw scores for both the CK and TSPCK were analysed using Rasch software. Both assessment

tools fell within the acceptable statistical range of -2 to +2 for validity. This gave the indication that the tools were measuring the single construct for which they were designed. In the CK assessment tool this is basic content knowledge and for the TSPCK assessment this is TSPCK reasoning with regard to the teaching of electric circuits. The statistical reliability for the CK assessment tool was established, at 0.71. The reliability of the TSPCK assessment was a low at 0.36, which means there is reasonable chance that a different set of results could be obtained if this tool was given to a different population.

The statistical analysis was not done in isolation but together with qualitative analysis. The CK assessment tool results were analysed, using the confidence rating, to determine the type and most prevalent misconceptions and content gaps. These misconceptions and content gaps are outlined in sub-section 4.3.3. The key areas where content gaps and misconceptions were detected from the CK assessment tool was the effect of adding resistors in parallel and the second area was the concept voltage and how it changes within a circuit system. This analysis was then compared to the raw scores and responses to the TSPCK tool. The TSPCK tool responses were qualitatively analysed looking for patterns and responses that were evidence of the type of reasoning required to transform content.

The theoretical construct of TSPCK assumes that the categories are hierarchical with learner misconceptions and prior knowledge being the easiest to respond to and conceptual teaching strategies the most difficult. The raw scores of TSPCK categories were qualitative analysed to see if they fit into this pattern. The greater the agreements with the theoretical construct the higher the degree of validity. This assessment tool did not completely fit into this hierarchical structure. The two categories which did not fit into this pattern were one item from category A which should have been a relatively easy item proved to be one of the most difficult and category was not the most difficult it placed in the middle of the difficulty continuum.

Finally the raw scores and the CK and the TSPCK were correlated using product-moment Pearson correlation coefficient. It is expected that there should be a positive correlation between the CK and TSPCK scores because the assumption is that without content knowledge it is not possible to demonstrate TSPCK. There is a positive relationship with the high level TSPCK scores and CK scores. In other words all the top TSPCK scores had good content knowledge, not all the top CK performers were able to score highly in the TSPCK assessment tool and none of the low CK performers were able to score highly in the TSPCK assessment tool.

The validation of both assessment tools speak to heart of this study and the findings in relation to the next section discusses the finding with reference to the research questions

7.2. Findings and discussion

7.2.1. Research question 1

1. *What are the most appropriate methods for designing assessment tools for measuring teachers' Content Knowledge (CK) and Topic Specific Pedagogical Content Knowledge (TSPCK) in electric circuits?*

Claim 1: Valuable research has been done into the core concepts, misconceptions and measurement of electric circuit content knowledge, so an assessment tool to measure CK in electric circuits can be adapted from the existing assessment tools in the science education literature.

The purpose of the CK assessment tool was to generate a score that serves as a reference point for the TSPCK assessment tool. This meant that the CK assessment tool needed to focus primarily on conceptual knowledge and less on the algorithmic type of

knowledge for which test questions are widely available, but which can be answered correctly by simply substituting values into a formula without real understanding of the concepts involved. I found three tests to measure content knowledge of electric circuits in the science education literature of which were potentially usable. This meant there was no need to create a CK assessment tool from scratch. The process was then to select the test which best suited the needs of this project and had an overlap of the required content. Two tests were selected and adapted to generate the CK assessment tool, namely the DIRECT (Engelhardt & Beichner, 2004) and the Three-tier test (Pesman & Eryilmaz, 2010). The procedure for selecting and excluding items is covered in section 4.2. The final CK assessment tool consisted of 20 multiple-choice items. As there was no need to extract deeper levels of thinking, the multiple-choice format was an appropriate method for the CK assessment tool as this format allowed for conceptual questioning without it being too time-consuming to complete.

Based on the Three-tier test test, I decided to add a confidence level rating. This allowed me to extract an additional layer of information, pin-pointing sites of misconceptions. An incorrect answer because of a misconception is conceptually different from an incorrect answer because of a lack knowledge. A misconception is a situation where a teacher believes they have a good grasp on the content but in fact is working with an incorrect understanding, whereas a teacher who has a knowledge gap does not know the content because of a lack of familiarity with the material and they are aware that they have missing knowledge. In some ways the teacher who is aware that they have a lack of understanding is easier to remediate than the teacher who holds a misconception. Teacher lack of knowledge and teacher-held misconceptions both impact TSPCK: a lack of knowledge will mean that the teacher cannot transform knowledge for teaching, while a teacher-held misconception means the teacher has some knowledge to transform but transforms it conceptually incorrectly and these incorrect concepts are transferred to learners.

The multiple-choice format with the addition of the confidence level rating is an appropriate way to measure CK in electric circuits because this format allows for large sections of knowledge to be assessed quickly and efficiently. The main thrust of the study was the TSPCK assessment tool so to spend an excessive amount of time and energy on the CK assessment tool would be counter-productive.

Claim 2: The Mavhunga and Rollnick model (2013) provides useful categories for the design of a TSPCK assessment tool, however within certain categories there are assessment challenges that could warrant revisions of some aspects of the items within these categories

The 5 Categories describing TSPCK designed by Mavhunga and Rollnick (2013) formed the theoretical framework for this project. This model was successfully used to design and validate a TSPCK assessment tool for electrochemistry by Ndlovu (2013), and is currently being used to design assessment tools in stoichiometry, acids and bases and chemical bonding. Its appropriateness for other science topics had already been established. This study formed part of a collective effort to design TSPCK assessment tools across multiple science topics using the same theoretical framework so a consistent approach could be developed across multiple topics. The broad structure of the TSPCK assessment for electric circuit fits into this wider context but there were challenges for this particular topic within this framework.

The 5 Categories were important to help define the focus when I was conceptualising items for the TSPCK assessment tool. Without the limits of the categories it would be difficult to conceptualise what type of items to include. In general, items were able to stimulate multifaceted answers that revealed teachers' reasoning in just a few sentences. As an overall guideline, the categories of the Mavhunga and Rollnick worked well and formed an exceptionally useful framework for the assessment tool. Within certain categories there were items that posed difficulties.

The Category A – Learner prior knowledge and misconceptions -is particularly relevant for this topic. Two common misconceptions were selected for this section, namely current weakens as it flows through the circuit and the effect of adding a resistor in parallel. Category A used the format of providing authentic verbatim responses to common student errors in a multiple choice format and then asking the teachers to provide reasons for their selection. The multiple-choice options of responses to errors were quite complex and were all basically correct and could all be selected depending on the context. It was the reasoning for the choice that was of interest and which I categorised. Additionally, an option to create their own response, together with their reasoning was also available. These items provided rich data, without requiring more than two or three sentences in response.

In other similar TSPCK assessment tools, in other science topics, Category A on misconceptions was ranked as the easiest category, but this was not the case for electric circuits. Misconceptions in electric circuits appear to quite stable and not easily disrupted (Mackay & Hobden, 2012), making confronting and correcting misconceptions particularly difficult in this topic. The fact one of the items in this category was statistically ranked as the most difficult item and this is a deviation from the expected pattern. The other item in this category was statistically ranked as the easiest item. However, this deviation is not there because there is a problem with format and structure of the items in this category, instead it has occurred because the confronting of misconceptions is particularly difficult in electric circuits. Dealing with misconceptions in electric circuits involves more than just identifying and correcting misconceptions because within each misconception there are several other closely inter-related topics attached to the misconception. For example, an error in a parallel connection may be present because of a misconception about current but the question may ask for an answer in terms of brightness, which is actually asking the student to answer using difference in power. This type of problem is common in this topic; this item posed challenges because it represented a task that is challenging.

The most notable difficulty was the time required by the respondents to complete the TSPCK assessment tool. This was particularly evident in Category B - Curricular saliency, with nearly half the respondents not even attempting this category. Within this category the item that seemed the most overwhelming was the concept map. A criticism of concept maps is that they require hierarchical organisation and don't always show complex inter-relations well (Morine-Dersheimer & Kent, 1999). The respondents who were categorised at an exemplary level (4) certainly did show the interconnections between the terms but these concept maps were so complex and showed so many cross links that the meaning and content became lost and difficult to follow. Considering the inter-connectedness of the concepts in electric circuits, this criticism is particularly valid. The respondents who did complete the concept maps to a level 3 or 4 evidenced many concepts and showed multiple connections between concepts. Showing this amount of complexity is extremely time-consuming. The concept map seemed to extract teachers' knowledge about electric circuits and not necessarily the reasons behind ranking and sequencing topics for teaching. The maximum amount of hierarchical levels in all the concepts maps was two, the difference between those categorised as exemplary and developing was the number of interconnection between terms. One of the respondents did not attempt to draw a mind-map but gave a very clear description and reasoning behind how she would sequence sub-topics within electric circuits. The concept map item is placed within Category B - Curricular Saliency, which is the category that describes the reasoning behind the order and timing of presenting concepts to learners. The concept map did not expose the sequencing because the knowledge hierarchy in this topic is quite flat. There is not an easy flow from most important to a sub-ordinate idea; understanding voltage is equally important to understanding current and resistance.

Category C - 'What is difficult to teach?' was answered clearly and yielded reasoned responses in just a few sentences. The insight the respondents showed about the impact that the use language has on the teaching of electric circuits was particularly noteworthy. Many electric circuit terms are used in everyday language. For example, 'I

need to charge my phone' implies that the phone is somehow filled up with new charges, which is the incorrect physics idea. It would be interesting to gather more responses to this question and to study the impact of language further. The format of this item worked well for the purposes of this assessment.

Category D – Analogies and representations was also clearly answered by most of the respondents. Teachers are comfortable to given their opinions on what they like and don't like, which is what this category was asking. Only one of the respondents was able to articulate where the representations failed, which is one of the discriminating factors between exemplary (4) and developing (3)

Category E – Conceptual teaching strategies. According to the Mavhunga and Rollnick model this category should be the most difficult category because it requires drawing all 4 of the other components into a cohesive strategy. This was borne out, in part, in this study. Respondents did find it difficult but not as difficult as the concept map and the question on parallel circuits. The questions in this category were scaffolded to assist teachers with structuring their responses. This scaffolding may have had the effect of being too leading, making it too easy. The scaffolded structure also meant that the item was quite long and perhaps a bit confusing to read. The question spanned two pages and some of the respondents gave the feedback that they did not immediately see which were the students' answers they had to respond to, so they did not really understand the question at first. Additionally the sub-topics of movement of charge, energy and energy transfer covered in this topic were not ones that posed as much conceptual difficulty for the teachers as resistors in parallel, so energy may not be the most appropriate sub-topic for this category. The sub-topic of energy conversion should possibly be moved to Category A and the conceptually more challenging parallel connections to Category E.

While there are challenges with certain items within the categories of the Mavhunga and Rollnick (2013) model, it does provide a very useful structure to organise and design assessment items to measure the complex construct of TSPCK. The fact that there are variations between science topics is to be expected and complies with broader theoretical framework of topic specificity of teaching science.

Claim 3: Being able to state that these assessment tools are the 'most appropriate' method to measure TSPCK is too strong a phrasing.

The major constraint of the TSPCK assessment tool is the length of time required to complete and the level of engagement required to answer it. There is a tension between extracting deep rich responses and requiring too much time and energy from the respondents. Written responses take time and if the teacher is rushed, she may not give as deep a response she is capable of. Other methods such as classroom observations, video observations, interviews, self-reflection journal are all potential methods for measuring teachers' TSPCK yet the strength of this assessment format is that it has been used across multiple topics so it is possible to compare results and observations. While completing this assessment tool is time consuming, it is not as time intensive as an interview. A compromise has to be reached between drawing out and evidencing rich responses and making the assessment process manageable. Written responses can be administered to a large number of teachers and they can complete the assessment tool at their own convenience. The written responses also mean that there is a permanent record of the response which can be analysed further or differently at another time. The written response type of assessment tool has both negative and positive aspects. A decision has to be made regarding which of these factors overrides the others, which is not a simple process.

The TSPCK assessment tool does measure what it was designed to measure, but it is by no means exhaustive. There is room for revision within certain categories, for example

the structure of the questioning with the concept map and perhaps changing the Category E item to include parallel connection. Other types of measurement, such as interviews, could be used in conjunction with the TSPCK assessment tool to correlate and improve the quality of data extracted. These assessment tools met the broad requirement of appropriateness, but the term 'most' appropriate is too strong.

7.2.2. Research question 2

2. How valid and reliable are the two assessment tools that were designed?

Claim 1: The CK assessment tool was proved to be both valid and reliable for both persons and items using quantitative and qualitative arguments.

The CK assessment tool was adapted from pre-existing assessments in literature which had thus already been tested for validity. So when this CK assessment tool was analysed using Rasch analysis, it was gratifying to find that it was statistically valid for both persons and items because the ZSTD scores fell between the required values of -2 and +2. The reliability values for persons was 0.70 and for items it was 0.57, still a reasonable level of reliability. A reliability level of above 0.80 would have been more conclusive. The inherent weakness of the small sample has impacted all the statistical analysis done in this study. The average score for the CK assessment tool was 80% which is a high average but is also to be expected considering that this sample was made up of highly qualified and experienced teachers. The 3 lowest performing respondents were all teachers who are not currently teaching Physical Science and who had the lowest number of years teaching Physical Science.

The addition of the confidence level provided another layer of data. Despite the overall performance in the CK assessment being very good, it emerged that certain

misconceptions were more prevalent in this sample group than others. A misconception was detected when a teacher got a question incorrect but gave the rating that they were confident about their answer. The most common misconception detected related to the impact of adding resistors in parallel to the current in circuit. The next two most common misconceptions in this sample group was (i) the inter-changeability of terms e.g. using the term power when the correct term would be energy and (ii) not recognising that current is the same throughout a series circuit and any change made in a circuit would cause the current to change throughout the circuit.

Despite the CK assessment tool being adapted from pre-existing and validity tests, the CK assessment tool was subjected to both quantitative and qualitative analysis for validity and reliability. Using forms of analysis both quantitative and qualitative argument there are good argument for validity and reliability.

Claim 2: The TSPCK assessment tool for electric circuits has good validity and reliability only if both the statistical data and the interpretive evidence are considered together. The reliability of the TSPCK assessment tool could be improved with some minor revisions to the TSPCK assessment tool.

In keeping with the Mixed-methods methodology, the TSPCK assessment tool was subjected to both quantitative and qualitative analysis. The Rasch analysis of the person and item measures were between the range of -2 and +2, indicating that a single construct was being measured. The Cronbach KR-20 of 0.97 was also within a statistically valid range, indicating that there was internal consistency within the tool. The reliability measures above 0.5 are traditionally considered acceptable. For the person measure this value is 0.94 indicating that this assessment tool is a good measure of this population. However, the item reliability in the TSPCK tool of 0.43 is below this statistical level and this indicates that it is possible that different results would be achieved if this tool was given to another sample population. The item separation

measure of 0.87 is also low and indicates that there was not enough variation between the difficulty levels of the items in the TSPCK assessment tool.

The low reliability and item separation scores could be attributed to the small sample size, which did not allow for enough variety in responses. Another factor that may have influenced this result was the time required to answer the TSPCK, which meant that some questions were omitted by the teachers. Half the sample did not attempt the concept map. The informal feedback I received from some of the respondents was that this item was too daunting to attempt within the timeframe available. This meant that the categorising for this item was polarised, with mostly exemplary or limited responses. A larger sample would probably give a better spread of results and hence a better indication of reliability. Thus, while the reliability is not at the level that I could conclusively report reliability; there are indications that reliability could be determined with a wider sample.

In addition to the statistical argument for validity and reliability, there is an interpretative argument to be made. The key component of the interpretative argument is the ability of the assessment tool to deliver enough data to discriminate reliably between the different categories. In order to achieve this, significant work was done on the assessment rubric. The development and the multiple validation processes of the assessment rubric are described in section 5.3.2. The work done on the assessment rubric is perhaps one of the key areas that this project has contributed to the wider science research group. The clarity of the rubric allowed for more accurate categorising of the TSPCK responses. This TSPCK assessment tool was able to differentiate different levels of reasoning according to the 5 TSPCK categories, thus performing the key function. The purpose of the TSPCK test was to draw out responses that evidenced different levels of teacher reasoning and this has been achieved and is evidenced with the variety of type and depth of response from the participating teachers. The rubric is a potentially powerful tool and could be used with another sample population to categorise teacher TSPCK. This component increases the argument for reliability.

The statistical and interpretive argument for validity is stronger than that for reliability. Many of the issues relating to reliability are due to the small sample size and type of the population sample. In order to conclusively show reliability the TSPCK tool will need to be completed by a larger and more diverse population. In addition to this, some revision to the TSPCK assessment tool may yield better results. One of the suggested revisions would be to re-design Category E – Conceptual teaching strategies – to include the topic of resistors in parallel and to reduce the amount of scaffolding. The topic of parallel connection was found to be most difficult topic, in this study, and as such it would be better suited to Category E that should be conceptually the most difficult to respond to. Another suggested revision is to scaffold the concept map item, for this topic, to make this item less daunting and to allow the respondents to feel more able to tackle this task. The concept map revealed more about how the teacher organised the content for themselves but did not reveal the how and they would sequence content or their reasons for doing so.

The strength of the Mixed-method methodology is that it allows for triangulation of data. The argument for validity is made both statistically and qualitatively, for the TSPCK assessment. There is evidence that the single construct of TSPCK is being measured. The majority of the ZSTD scores for both items and persons were within the range of -2 and +2, which provided the statistical argument for validity. The argument for reliability is not as strong and if only the statistical argument was considered then there would be some concerns with regards to reliability. The Rasch score for person reliability was 0.97 and for items was 0.43. However, the interpretative arguments indicate that reliability for this assessment tool could be achieved with further sampling and possibly some revision to placement of sub-topics within the assessment tool. A larger sample could show a wider range of item difficulty. A sample with a wider range of ability could also improve the reliability score. While the reliability scores are relatively low they are not as low as to rule out the prospect that further sampling will yield more convincing results.

7.2.3. Research question 3

3. What is the relationship between teachers' CK and TSPCK?

Claim 1: CK and TSPCK are distinct knowledge bases. Strong CK in electric circuits does not imply that a teacher will have strong TSPCK, however where a teacher has weak CK in electric circuits, she will have weak TSPCK.

The CK assessment tool was developed from existing tests in the electric circuit literature and this assessment tool showed a good degree of validity and reliability when subjected to Rasch analysis. The trustworthiness of this assessment tool meant that the raw data obtained from this tool had credibility. The content knowledge level of the sample population was very good, with an average of 80%, the highest score was 100% and the lowest was 25%. Four of the respondents got only one question incorrect.

There is moderate statistical evidence of a positive linear relationship, which was calculated with a product-moment Pearson correlation coefficient of 0.45, which indicates limited predictive ability of CK for TSPCK levels. The predictive ability was strongest at the lower end of the CK scores, with none of the lower performers in the CK assessment tool being able to transform knowledge into the reasoning required for TSPCK. At the upper end, strong CK scores did not necessarily translate into an ability to transform this knowledge, with the top performers in the CK assessment tool achieving varying levels of TSPCK from developing to exemplary. The top TSPCK raw scores came from respondents with very good content knowledge but not from the top performers. This indicates that the knowledge required for TSPCK reasoning is different from just pure content, which lends credibility to the construct of TSPCK. There was clear interpretative evidence for the correlation of the CK and the TSPCK assessment tool.

The observed relationship between the CK and TSPCK assessment tool can be summarised as follows: that without the foundation of content knowledge it is impossible to express TSPCK thinking. The presence of good content knowledge is a prerequisite for TSPCK reasoning. Once the content knowledge is in place, the reasoning required around transforming knowledge is a connected but separate skill and knowledge base.

Claim 2: The CK and TSPCK knowledge bases, while being distinct from each other, are interdependent on each other.

The CK assessment tool revealed that questions relating to parallel connections were the most problematic. The use of terminology and the correct conceptual understanding of physical properties such as voltage, power, resistance, current, energy and charge was the next most common area that the teachers got incorrect. The final content area that was a problem, but to a lesser extent, was the understanding that a change in a series circuit impacts the current in the same way throughout the circuit and not just after the a circuit component..

The information about the sites of misconceptions was useful when analysing the TSPCK items that covered these areas. The items that covered this same topic in the TSPCK assessment were found to be the most difficult. When a misconception was held by a respondent there is evidence that the same misconception persisted in the TSPCK assessment tool responses. This indicates that the CK assessment tool not only provided a valid score for content knowledge of electric circuits but also provided insight into the misconceptions held by teachers. The correlation between the observed misconceptions and the items that the respondents found difficult in the TSPCK is an argument for the validity of the CK assessment tool and shows that misconceptions in CK persist into TSPCK. However, there were respondents who did not hold the

misconceptions themselves yet were still unable to identify and address them in learners. This reiterates the point that weak CK will translate into weak TSPCK, but strong CK does not automatically transfer into strong TSPCK.

In the topic of electric circuits it is possible to use algorithmic methods to get to the correct answer and not necessarily understand the concepts behind the calculation. The respondents with stronger TSPCK did not revert to purely algorithmic explanation but focused on inter-relations between concepts and used the algorithmic explanations as one part of their explanation. The respondents who exhibited weaker TSPCK reverted to algorithmic explanations and selected the Ohm's law formula of $R = \frac{V}{I}$ as a 'Big Idea'. The type of knowledge also determines the type of transformation. Teachers with high level TSPCK focus on the conceptual understanding of topics and the algorithmic component is used as a secondary component whereas teachers with lower scores in the TSPCK focused on the algorithmic explanations and could not expand on the concepts underpinning the mathematical expressions. This is a useful idea because it is readily observed in the teacher responses and a useful coding criteria.

7.2.4. Overall Research Aim

Design a valid and reliable assessment tool to measure TSPCK in electric circuits

The over-arching aim of this study was to design a valid and reliable assessment tool to measure teachers' TSPCK in electric circuits. This has been proven to be possible, nevertheless the final TSPCK assessment tool could benefit from some revisions to increase the level of reliability.

7.3. Reflections on the study

7.3.1. Concept of PCK and TSPCK

At the start of the study I struggled with the concept of PCK and the related concept TSPCK. I did not understand what it was because the definitions of PCK and TSPCK are what I would have considered as part of 'normal teaching' and not a definable or a distinct knowledge type. Kind (2009) mentions the difficulty of measuring PCK directly because it is tacit knowledge, and teachers do not directly verbalise their 'PCK'. It is an internal and personal construct. The literature review of all the PCK models and adaption highlights how difficult it is to define. The switch of terminology between authors also made understanding the construct difficult to grasp. For example I did not see the terms of content knowledge and subject matter knowledge as particularly different but Shulman used the term 'subject matter content knowledge' in his 1986 paper, changed the term to 'content knowledge' in his 1987 paper but both referring to science knowledge, then Veal and Makinster used the term 'subject matter knowledge' to refer as a type of knowledge integrated within PCK. And content knowledge is just the starting point to develop PCK. The models of PCK were adapted to include more and more factors and terms were defined and redefined which all added to the confusion.

However, on an intuitive level I could understand that what teachers do is special and distinct. I have observed several well-qualified knowledgeable people be quite awful in a classroom and just not know how to make content accessible, I have heard the phrase '*he is too smart to teach*' on many occasions. The idea that what teachers do to knowledge is a distinct and professional skill resonated with me. On a practical level I could also understand that how I would teach one topic is different from another topic so I could conceptualise the construct of TSPCK in practical terms.

The Consensus model developed at the PCK summit and published in Gess-Newsome (2014) goes a long way to clarifying the construct of PCK and bringing together multiple perspectives into a common definition. The addition of the idea of skill is also useful because a teacher may have the knowledge about various strategies but not have the

skill to apply them. Overall the construct of PCK validates the professional expertise of teachers and elevates the work that they do.

7.3.2. Electric circuits and TSPCK

In the initial stages of the study I had to review the literature for common misconceptions, many of which I had encountered in the classroom but had not encountered the description of the misconceptions. This exercise was extremely valuable for me because it gave me vocabulary for what I was observing and I was able to be clearer about confronting these in my students. However, it also highlighted how each topic that is taught has its own body of knowledge of misconceptions and potential strategies. The length and extent of Loughran's CoRe's for each topic emphasises just how much a teacher has to know before delivering material to a class.

Being aware of the depth of knowledge required by a teacher was only the starting point; taking the next step to assessing and ranking this knowledge was another new level. Conceptualising items for the TSPCK was completely new territory for me. Understanding the Mavhunga and Rollnick TSPCK and how it was useful for defining and measuring TSPCK was the key component to developing the TSPCK assessment tool.

I have taught electric circuits for several years and at various grade levels and had almost become mechanistic in my delivery. I had not considered the subtle conceptual challenges that learners face when trying to come to grasp with electric circuits. One respondent reflected on the importance of small words like, '*on*', '*through*' and '*across*' on student understanding which I had not previously considered. The challenge of the everyday language impacting on physics understanding was a new idea to me, for example 'I have run out of battery' is a common phrase but conceptually completely wrong. Conventional teaching wisdom proposes that a teacher should connect the content to everyday experiences so a student can relate to it and make a connection to

help understanding. I am not sure this is true for electric circuits because the everyday experience of electricity and vocabulary around electricity potentially impedes understanding. In many other physics topics we define a new concept and give the students a new vocabulary for that concept. In electric circuits the students have an embedded vocabulary so the teacher has to replace language as well as generate understanding. This is just one aspect that makes the topic of electric circuits challenging. The TSPCK model allows for discovery and investigation at a very narrow level which allows for the unique transformation required for a specific topic to be discovered.

7.4. Limitations of the study

The single most significant limitation was the sample size and type. The sample size of 16 respondents was not enough to gather statistical data on reliability. All of the teachers in the sample being highly qualified coming from well-resourced schools, which means in terms of the South African context it was not a typical group of teachers. This means the results cannot be generalised. The size of the sample is a significant limitation and does reduce the confidence for reliability for the TSPCK instrument.

Within the instrument itself there are certain limitations

- The length and type of responses meant that it demanded a great deal from teachers.
- A written response requires effort and may not reveal all the depth of reasoning that a teacher uses.
- The item that covered the most prevalent misconception appeared early in the TSPCK assessment tool and may have been better placed later in the tool.
- The concept map item was poorly answered and often omitted. This item was particularly intimidating for the teachers.

- The initial pilot was not broad enough because some of these issues could have been exposed earlier with a more extensive pilot program.

7.5. Recommendations moving forward

7.5.1. Methodology

The Pilot TSPCK was quite long and the numbers of items had to be reduced for the final assessment tool. If I was to design a similar assessment tool, I would spend more time on the piloting phase and perhaps design different shorter tools and try to get a wider variety of responses.

Collecting the responses for the CK and TSPCK assessment tool relied on the goodwill of the teaching community. Teachers are pressured for time and often want to help but just are not able to get to something that is not an immediate priority. I am grateful for my colleagues that were able give of their time and expertise. However, this time pressure did impact on the quality of the answers given. Many of the responses appeared to be rushed and in informal discussion with some of teachers their verbal responses showed greater depth than their written responses. Interviews are also time-consuming but I wonder whether if some items were answered verbally, a wider range of reasoning could have been evidenced. Another possibility would be to create an online platform that is quicker to answer and a bit more fun. The problem with this is that the required depth could also be impacted.

7.5.2. Item revision

There are 3 items in the TSPCK assessment tool that could potentially be revised. In Category A – Learner misconceptions, I would recommend that the item on parallel connection be moved and replaced with an item on energy conversion in electric circuits. The item on parallel connection was too challenging early on in the assessment

tool. The next item suggested for revision is the concept map. The particularly complex nature of the concept map in electric circuits makes this a daunting item, so including some type of scaffolding may help make this item more accessible. The final suggested item for revision is in Category E. I would suggest that the conceptually difficult topic of parallel connections be used in this category to increase the opportunity for respondents to present their conceptual strategies.

7.5.3. Large scale testing

To increase the level of validity and to confirm reliability, it would be of value to test the assessment tool on a wider population. In addition to increasing the number within the sample population, it would be of benefit to test with a wider variety of teachers. The possibility exists to put the tools on an online platform but some work needs to be done on improving or finding an alternative method for the concept map.

7.5.4. The use of the TSPCK assessment tool in the training of pre-service teachers

A possible place to utilise these tools is with pre-service teachers. The CK assessment tool focusses on conceptual knowledge and exposes misconception relatively easily. It is essential that misconceptions held by pre-service teachers are remediated before they enter the classroom. The TSPCK tool also is a discussion point; however, pre-service teachers might not have the exposure to this particular topic. However, written responses from respondents are available and could be used as a starting point for discussion. Making visible the nature and type of misconceptions that learners hold or even the pre-service teachers hold, is useful information and could help a pre-service teacher be effective in this topic.

7.5.5. The use of the TSPCK assessment tool in the training of in-service teachers

The mediation of student misconceptions has been shown to be especially critical in the understanding of electric circuits. Gaigher (2014) observed in her study that teachers could identify the incorrect answer given by their students but not the misconceptions or the reasoning behind why the student gave the incorrect answer. The CK and TSPCK assessment tool, together with explicit explanations of common misconceptions could be of value to both in-service and pre-service teachers.

Beyond good content knowledge, knowledge of common misconceptions could be extremely useful for teachers to develop more effective conceptual teaching strategies to mediate students' understanding of electric circuits. Both the CK and TSPCK assessment tool could be used as discussion starting points for teacher workshops.

Grayston, (2004) makes the assertion that having content knowledge and knowledge of student misconceptions is not enough to help students mediate conceptual difficulties involved in electric circuits but that teaching strategies needed to mediate these conceptual difficulties need to be explicitly developed. These tools provide a means for collecting and sharing this type of knowledge that teachers are often unaware they have and don't always recognise the value of their accumulated knowledge. The construct of PCK and TSPCK is potentially an affirming idea for teachers to be exposed to. The recognition that the knowledge they hold is unique and specialist is not a message that teachers receive often.

7.5.6. Directions for future research

If the recommended revisions are made a similar process of validation will be required and then compared to the results of this sample to ascertain if the revisions do improve the reliability of the assessment tool and if they make completing the assessment tool more accessible.

The assessment tools, in their current form are still useful and are available to be used for further study. They could be used to measure changes in CK and TSPCK, within a sample, over time e.g. comparing answer from the 1st year of teaching to a few years later.

The importance of student misconceptions and the difficulty teachers have in identifying and confronting them was shown to be as difficult as the conceptual teaching category, which is theoretically the most difficult category, it would be interesting to know if this is an isolated finding with this group or if it is a general phenomenon within this topic and to investigate why the teachers found this difficult. Together with this a study in this topic on the impact of language on conceptual understanding teaching strategies could be valuable.

7.6. Conclusions and implications

A number of researchers have designed assessment tool measuring PCK and TSPCK (Mavhunga & Rollnick, 2013 and Ndlovu, 2014) and this study adds to a growing body of tools. The aim of the study was to develop and validate assessment tools to measure teachers CK and TSPCK in electric circuits. This has been achieved. The validity of the tools has been confirmed quantitatively and qualitatively. There is less confidence with the reliability of the tools but enough evidence of reliability to be reasonably confident that if the tools were tested with a larger sample, reliability would be determined.

There were two assessment tool designed, namely the CK and TSPCK tools for electric circuits. The purpose of the CK was to measure content knowledge and to detect the presence of misconceptions within teachers, using a confidence rating scale. The CK tool did expose misconceptions in this sample, even though the overall performance was good. There was evidence that the misconceptions persisted into the TSPCK tool.

The second tool was the TSPCK tool and its purpose was to extract and measure TSPCK level. This was achieved. The type of items did elicit varying depth of response and the TSPCK rubric designed was effective in discriminating between different categories. Designing the TSPCK rubric was the most rewarding part of the study. The subtle variation of the different levels of thinking meant that the rubric had to be carefully conceptualized and re-worked multiple times. The final product was able to differentiate well between different levels of TSPCK reasoning and as such is a good contribution to the TSPCK community. The TSPCK assessment tool was determined to be statistically valid and it can be concluded that it does measure the single construct of TSPCK.

The final conclusion is that valid and reliable assessment tools for CK and TSPCK for electric circuits have been designed and are now available for use to the wider research community.

REFERENCE LIST

- Aydin, S. (2012). *Examination of chemistry teachers' topic specific nature of pedagogical content knowledge in electrochemistry and radioactivity*. Doctoral Dissertation, Middle East Technical University, Graduate School of Natural and Applied Science, Ankara, Turkey.
- Aziz, A. (2010). *Rasch analysis: A practical guide to Winsteps*.
- Ball, D., Thames, M., & Phelps, G. (2008). Content knowledge for teaching. *Journal of Teacher Education, 59*(5), 389 - 407.
- Baxter, J., & Lederman, G. (1999). Assessment and measurement of pedagogical content knowledge. In J. Gess-Newsome, & N. Lederman, *Examining Pedagogical Content Knowledge* (pp. 147 - 161). Dordrecht: Kluwer Academic.
- Bertram, A., & Loughran, J. (2011). Science teachers' views on CoRes and PaP-ers as a framework for articulating and developing Pedagogical Content Knowledge. *Research in Science Education, 1*-21.
- Biggs, J. &. (1982). *Evaluating the Quality of Learning: the SOLO Taxonomy*. New York: Academic Press.
- Bond, T., & Fox, C. (2001). *Applying the Rasch model: fundamental measurement in the human sciences*. Mahwah: Lawrence Erlbaum Associates.
- Boone, W., & Rogan, J. (2005). Rigour in quantitative analysis: The promise of Rasch analysis techniques. *African Journal of Research in Mathematics, Science and Technology Education, 9*(1), 25-38.
- Boone, W., & Scantlebury, K. (2006). The role of Rasch analysis when conducting science education research utilizing multiple-choice tests. *Science Education, 90*(2), 253-268.
- Burke Johnson, R., & Onwuegbuzie, A. (2004). Mixed method research: a research paradigm whose time has come. *Educational Researcher, 33*(7), 14 -26.
- Chisholm, L. (2009). *An overview of research, policy and practice in teacher supply and demand. (Teacher Education in South Africa Series)*. Cape Town : HSRC Press.
- Cochran, K., DeRuiter, J., & King, R. (1993). Pedagogical content knowing: an integrative model for teacher preparation. *Journal of Teacher Education, 44*(4), 263-272.
- Cochrane, F., & Jones, L. (1998). The subject matter knowledge of pre-service teachers. In B. Fraser, & K. Tobin, *International Handbook of Science Education* (pp. 707-718). Great Britain: Kluwer Academic Publishers.

- Cresswell, J. (2012). *Education research: Planning, conducting and evaluating quantitative and qualitative research (4th Ed)*. USA: Pearson Education Inc.
- Davidowitz, B., & Rollnick, M. (2011). What lies at the heart of good undergraduate teaching? A case study in organic chemistry. *Chemical Education Research and Practice*, 12, 355-366.
- Dempster, E., & Reddy, V. (2007). Item readability and science achievement in TIMSS 2003. *Science Education*, 91(6), 906 - 925.
- Department of Basic Education. (2011). *Curriculum and Assessment Policy Statement*. Republic of South Africa.
- du Toit, E. (2006). *OBE Plus Physical Science Learning Guide Grade 10* (Vol. Module 3). Centurion: Future Entrepreneurs.
- Dupin, J., & Joshua, S. (1987). Conceptions of French pupils concerning electric circuits: Structure and evolution. *Journal of Research in Science Teaching*, 24, 98-115.
- Engelhardt, P., & Beichner, R. (2004, January). Students' understanding of direct current resistive electrical circuits. *American Journal of Physics*, 72, 98 -115.
- Facets help for many-facet Rasch measurement*. (n.d.). Retrieved January 31, 2015, from Ministep (winsteps) Rasch: <http://www.winsteps.com>
- Gaigher, E. (2014). Questions about answers: Probing teacher awareness and planned remediation of learners' misconceptions about electric circuits. *African Journal of Research in Mathematics, Science and Technology Education*, 18(2), 176-187.
- Geddis, A. (1993). Transforming subject-matter knowledge: The role of pedagogical content knowledge in learning to reflect on teaching. *International Journal of Science Education*, 15, 673 - 683.
- Geddis, A., & Wood, E. (1997). Transforming subject matter and managing dilemmas: A case study in teacher education. *Teaching and Teacher Education*, 13(6), 611-626.
- Gess-Newsome, J. (2002). Pedagogical Content Knowledge: an Introduction and Orientation. In J. Gess-Newsome, & N. Lederman (Eds.), *Examining Pedagogical Content Knowledge. The Construct and its Implications for Science Education* (pp. 3 - 17). New York: Kluwer Academic Publishers.
- Gess-Newsome, J. (2014). A model of teacher professional knowledge and skill including PCK.
- Gess-Newsome, J., & Carlson, J. (2013). A Report on the PCK Summit: Current and Future Research Directions. *NARST - PCK Summit*. Puerto Rico.

- Grayson, D. (2004). Concept substitution: Ateaching strategy for helping students disentangle related physics concepts. *American Journal of Physics*, 72(8), 1126 - 1133.
- Grossman, P. (1990). *The making of a teacher: Teacher knowledge and teacher education*. New York: Teacher College Press.
- Gunstone, R., Mulhall, P., & McKittrick, B. (2009). Physics teachers' perceptions of the difficulty of teaching electricity. *Research in Science Education*, 39, 515-538.
- Hammer, D. (1996). More than misconceptions. Multiple perspectives on student knowledge and reasoning and an appropriate role for education research. *American Journal of Physics*, 64, 1316 - 1325.
- Hart, C. (2008). Models in physics, models for physics learning, and why the distinction may matter in the case of electric circuits. *Research in Science Education*, 38, 529-544.
- Heller, J., Daehler, K., Shinohara, M., & Kaskowitz, S. (2004). Fostering Pedagogical Content Knowledge about electric circuits through case-based professional development. *National Association for Research on Science Teaching*, (pp. 1- 29). Vancouver.
- Jaakkola, T., Nurmi, S., & Veermans, K. (2011). A comparison of students' conceptual understanding of electric circuits in simulation only and simulation-laboratory contexts. *Journal of Research in Science Education*, 48(1), 71-93.
- Johnston, P., & Onwuegbuzie, A. (2004). Mixed methods research: A research paradigm whose times has come. *Educational Researcher*, 33(7), 77-90.
- Kind, V. (2009). Pedagogical Content Knowledge in science education: perspectives and potential for progress. *Studies in Science Education*, 45(2), 169 - 204.
- Linacre, J. (2012). *Winsteps (Version 3.81.0 [Computer Software])*. Retrieved December 2014, from <http://www.winsteps.com/>
- Loughran, J., Berry, A., & Mulhall, P. (2004). In search of Pedagogical Content Knowledge in Science: Developing ways of articulating and documenting professional practise. *Journal of Research in Science Teaching*, 41(4), 370-391.
- Loughran, J., Berry, A., & Mulhall, P. (2006). Chapter 8 Electric Circuits. In J. Loughran, A. Berry, & P. Mulhall, *Understanding and Developing Science Teachers' Pedagogical Content Knowledge* (pp. 185 - 217). Rotterdam: Sense Publishers.
- Loughran, J., Berry, A., & Mulhall, P. (2006). *Understanding and developing science teachers' pedagogical content knowledge*. Rotterdam: Sense Publishers.

- Mackay, J., & Hobden, P. (2012). Using circuit and wiring diagrams to identify students' preconceived ideas about basic electric circuits. *African Journal of Research in Mathematics, Science and Technology Education*, 16, 131-144.
- Magnusson, S., Krajcik, J., & Borko, H. (1999). Nature sources and development of Pedagogical Content Knowledge for Science teaching. In J. Newsome, & N. Lederman (Eds.), *Examining Pedagogical Content Knowledge: the construct and its implications for Science education* (pp. 95-132). Dordrecht: Kluwer Academic.
- Mavhunga, E. (2012). *Explicit inclusion of Topic Specific Knowledge for teaching and the development of PCK in pre-service teachers*. Doctoral Dissertation, University of the Witwatersrand, Wits School of Education, Johannesburg.
- Mavhunga, E., & Rollnick, M. (2012). Improving PCK of chemical equilibrium in pre-service teachers. *African Journal of Research in Mathematics, Science and Technology Education*, In Press.
- Mavhunga, E., & Rollnick, M. (2013). Improving PCK of chemical equilibrium in pre-service teachers. *African Journal of Research in Mathematics, Science and Technology Education*, In Press.
- McDermott, L., & Shaffer, P. (1992). Research as a guide for curriculum development: An example from introductory electricity. Part I: Investigation of student understanding. *American Journal of Physics*, 60(11), 994-1013.
- McMillan, J., & Schumacher, S. (2001). *Research in Education: A Conceptual Introduction* (Fifth Edition ed.). New York: Longman.
- Messick, S. (1995). Validity of psychological assessment; validation of inferences from person's responses and performance as scientific enquiry into score meaning. *American Psychologist*, 50, 741 - 749.
- Michelet, S., Adam, J., & Luengo, V. (2007). Adaptive learning scenarios for detection of misconceptions about electricity and remediation. *International Journal of Emerging Technologies in Learning*, 1 - 5.
- Moodie, P., Lamont, J., McKay, I., McKay, M., & Keogh, M. (2000). *Science for all: Grade 9 Learner's Book*. Manzini, Swaziland: Macmillan.
- Moran-Ellis, J., Alexander, V., Cronin, A., Dickinson, M., Fielding, J., Sleney, J., et al. (2006). Triangulation and integration: processes, claims and implications. *Qualitative Research*, 6(1), 45-59.



- Morine-Dersheimer, G., & Kent, T. (1999). The complex nature and sources of teachers pedagogical knowledge. In J. Gess-Newsome, & N. Lederman, *Examining Pedagogical Content Knowledge* (pp. 5 - 17). Dordrecht: Kluwer Academic Publishers.
- Mulhall, P., McKittrick, B., & Gunstone, R. (2001). A perspective on the resolution of confusions in the teaching of electricity. *Research in Science Education, 31*, 575 - 857.
- Mulhall, P., McKittrick, B., & Gunstone, R. (2001). A Perspective on the Resolution of Confusions in the Teaching of Electricity. *Research in Science Education, 31*, 575 - 857.
- Ndlovu, M. (2014). *The design of an instrument to measure physical science teachers' topic specific pedagogical content knowledge in electrochemistry*. Thesis, University of the Witwatersrand, Johannesburg.
- Neuman, W. (2000). *Social research methods: Qualitative and quantitative approaches*. Boston: Allyn and Bacon.
- Oosterveld, P., & Vorst, C. (1996). Methoden voor vragenlijstconstructie [Methods of test construction]. *Nederlands Tijdschrift voor de Psychologie, 51*, 11-27.
- Park, S., Jang, J., Chen, Y., & Jung, J. (2011). Is Pedagogical Content Knowledge (PCK) necessary for reformed science teaching. *Research in Science Education, 41*, 245-260.
- Pesman, H., & Eryilmaz, A. (2010). Development of a three-tier test to assess misconceptions about simple electric circuits. *The Journal of Educational Research, 103*, 208 - 222.
- Riese, J., & Reinhold, P. (2009). Measuring physics student teachers' Pedagogical Content Knowledge as an indicator of their professional action competence. *Paper presented at European Science Education Research Association 2009 Conference*. Istanbul, Turkey.
- Rohaan, E., Taconis, R., & Jochems, W. (2009). Measuring teachers' Pedagogical Content Knowledge in primary technology education. *Research in Science and Technological Education, 27*(3), 327-338.
- Rollnick, M., & Mavhunga, E. (2013). How do different conceptions of PCK shape the methods devised for assessing PCK? *NARST - PCK Summit*. Puerto Rico: BSCS.
- Rollnick, M., Bennett, J., Rhemtula, M., Dharsey, N., & Ndlovu, T. (2008). The place of subject matter knowledge in PCK - A case study of South African teachers teaching the amount of substance. *International Journal of Science Education, 30*(10), 1365-1387.
- Rollnick, M., Mavhunga, E., Malcolm, S., Zimmerman, G., Bam, N., & van der Merwe, D. (2015). PCK Instruments: Are we measuring PCK? *23rd Annual Conference of the Southern*

African Association for Research in Mathematics, Science and Technology Education.
Maputo, Mozambique.

- Scaife, J. (2004). Reliability, Validity and Credibility. In C. Opie (Ed.), *Doing educational research* (pp. 58 - 72). London: SAGE Publications.
- Selvaratnam, M. (2011). Competence of matric physical science teachers in some basic problem-solving strategies. *South African Journal of Science*, 107(1).
- Shipstone, D., Rhoneck, C., Karrqvist, C., Dupin, J., Joshua, S., & Licht, P. (1988). A study of students' understanding of electricity in five European countries. *International Journal of Science Education*, 10, 303-316.
- Shulman, L. (1986). Those who understand: knowledge growth in teaching. *Educational Researcher*, 15(2), 4 - 14.
- Shulman, L. (1987). Knowledge and teaching: foundations of the new reform. *Harvard Educational Review*, 57(1), 1-22.
- Summers, M., Kruger, C., & Mant, J. (1998). Teaching electricity effectively in the primary school: a case study. *International Journal of Science Education*, 20(2), 153 - 172.
- Tarciso Borges, A., & Gilbert, J. (2010). Mental models of electricity. *International Journal of Science Education*, 21(1), 95 -117.
- Van Driel, J., De Jong, O., & Verloop, N. (2002). The development of pre-service chemistry teachers' pedagogical content knowledge. *Science Education*, 86(4), 572-590.
- van Driel, J., Verloop, N., & de Vos, W. (1998). Developing Science Teachers' Pedagogical Content Knowledge. *Journal of Research in Science Teaching*, 35(6), 673 - 695.
- Veal, W., & Makinster, J. (1999). Pedagogical content knowledge taxonomies. *Journal of Science Education (Revista de Educacion en Ciencias)*.
- Wagner, C., Kawulich, B., & Garner, M. (2012). *Doing social research: A global context*. London: McGraw-Hill Higher Education.

APPENDIX A: FINAL TSPCK ASSESSMENT TOOL

Masters research project – Protocol Number 2013ECE064M – Gwyneth Zimmerman

University of the Witwatersrand Private Bag 3 Wit 2016 Johannesburg SA (t27 11 7170401 f21917381621)

Electric Circuit TSPCK Tool

The purpose of this research is to find the difficulties teachers experience and the strategies teachers use when teaching Electric circuits at the Grade 10 level. The assessment instrument consists of two parts: (i) Electric circuit content tool and (ii) Electric circuit Topic Specific Pedagogical Content Knowledge tool

The information will be used for research purposes only: your responses will be treated confidentially. Codes will be used to protect your identity.

Demographic Information

CODE:			
NAME:			
GENDER	Male	Female	
SUBJECTS YOU ARE CURRENTLY TEACHING			
NUMBER OF YEARS TEACHING SCIENCE			
QUALIFICATIONS			
Degree / Diploma	Where Obtained	Main Subjects	Year
Have you taught electric circuits?		YES	NO
If yes, please indicate the grade and the number of years for each Grade.			
Grade	Number of years	Years (e.g. 2008, 2009)	

Masters research project – Protocol Number 2013ECE064M – Gwyneth Zimmerman

There are 5 categories of questions in this tool

CATEGORY A:

- Category A contains typical student responses. Please indicate how you would respond to learners in each case i.e. what feedback you would give learners. Provide as much detail as possible.

CATEGORY B:

- Category B relates to planning and sequencing of topics. Your responses will assist in developing a consensus on the main ideas. Main ideas are statements describing key understanding that must be learnt in a topic.

CATEGORY C:

- Category C asks you to reflect on which ideas about electric circuits are difficult to teach and get across to learners. This will help us generate a list of difficult ideas that we can use for future research.

CATEGORY D:

- Category D provides 2 groups of representation and analogies. Think about which ones you find more useful and then fill in the table relating to the effectiveness of these analogies in the classroom setting

CATEGORY E

- Category E gives you a student's exercise and asks you to think about how you would assist this learner develop her conceptual understanding of electric circuits.

Instructions

- Please type or write responses directly into the response boxes.
- Please be as detailed as possible as to how you respond in your teaching setting

Thank you for your valued input and assistance

Electric Circuit TSPCK Instrument

Category A – Typical Student Responses

The two questions below are typical multiple choice items that students have answered incorrectly. A selection of possible teacher responses are provided, none of which are incorrect. Select the response you would most likely use in your practice and explain the reason for your response

A1. How would you comment in writing to the student who **selects B** as the answer to the question below, where A_1 and A_2 are ammeters

Which one of the following options is correct for the circuit shown below?

- A. $A_2 > A_1$
- B. $A_1 > A_2$
- C. $A_1 = A_2$

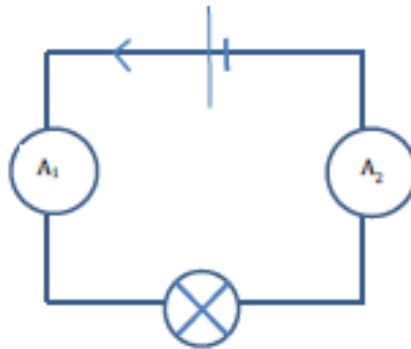

Response A: Keep in mind that this is a series circuit so current is not divided; therefore the correct answer is C. The current is the same throughout the circuit

Response B: Current is the rate of flow of charge. In this case the charge flowing is electrons. Electrons are particles that have mass and cannot disappear as they flow around the circuit. None of the electrons disappear through the circuit so the correct answer is C

Response C: Charged particles move under the influence of the electric field created by the battery, all the charged particles are in the same field, with the easiest path being in the single, undivided conductor. The flow of the charged particles is same throughout, so the correct answer is C

Response D: None of the above

Masters research project – Protocol Number 2013ECE064M – Gwyneth Zimmerman

Choose your response, and expand on the reason for your selection in the space provided

My choice is _____

My reason is

A2. How would you respond verbally to a student who answers B to the following question?

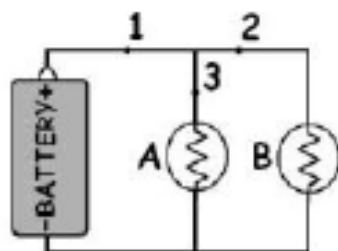

Figure 6

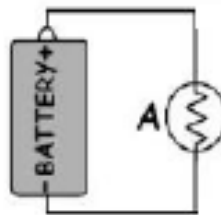

Figure 7

Compare the brightness of Bulb A in Figures 6 and 7.

- A. Brighter in Figure 6
- B. Brighter in Figure 7
- C. The same in the both figures

Response A: Just because there are two light bulbs in figure 6, doesn't mean that A will burn brighter. The brightness is dependent on the amount of current moving through the bulb. In Figure 6 the current has been divided at the parallel connection. The presence of the parallel connection means resistance is halved so current is doubled so the amount of current through the parallel branches, in this case, is the same as through the single bulb so there is no difference in brightness.

Response B: All the bulbs are identical; their brightness is dependent on how efficiently they can transform energy, which is defined by the term power. In electric circuits power can be calculated by $P = VI$. In the parallel connection if we calculate the equivalent resistance of the parallel connection. If we assume a resistance of 2Ω then $\frac{1}{R_T} = \frac{1}{2} + \frac{1}{2}$ which is equal to 1Ω exactly half the overall resistance in Figure 7. Seeing that as voltage stays the same current would be doubled and then halved again at the parallel connection, so the same amount of current is available to be transformed.

Response C: You seem to have missed that the bulbs in figure 6 are connected in parallel. At the parallel connection the current divides. The bulbs have identical resistance so the current will divide equally through both branches. Two bulbs in parallel halves the resistance, which doubles the current, which is then halved again at the parallel connection, so the net effect is zero and bulbs will burn equally bright.

Response D: None of the above

Choose your response, and expand on the reason for your selection in the space provided

My choice is _____

My reason is _____

Category B – Planning and Sequencing

A selection of content and concepts relating to electric circuits is provided. The question below refers to how knowledge and concepts are ranked and how a teacher makes connections between content and concepts.

B1. Review the list of concepts relating to electric circuits below.

Select and rank three foundational concepts, that you regard, as both basic and central concepts in electric circuits.

1. To obtain an electric current there needs to be a continuous loop from one battery terminal to the other terminal
2. An electric current is the net flow of charge.
3. Parallel connection in a circuit are current dividers
4. The materials that make up the circuit provide the charged particles when there is an electric current
5. A battery provides the energy for an electric current
6. Voltage can be defined as $J.C^{-1}$
7. Ohm's law can be expressed as $V = \frac{R}{I}$
8. When there is a current, energy flows from the battery to the external circuit.
9. Resistance is the opposition to current flow
10. A battery creates an electric field within the materials that make up the circuit. The electric field is the cause of current flow.
11. The resistance of a parallel connection can be calculated by $\frac{1}{R_T} = \frac{1}{r_1} + \frac{1}{r_2} + \frac{1}{r_3} \dots$
12. An electric circuit is a system in which changes in one part can affect other parts
13. Power is the rate at which energy is dissipated by the circuit component.
14. Current measured with an ammeter and voltage by a voltmeter

Write the number of the concepts you have selected, in order of importance.

Concepts
Concept 1.
Concept 2.
Concept 3.

B2. Using the three selected concepts from B1, give the sequence you would teach them in and your reasons for doing so

Concept	Reason for sequence

Masters research project – Protocol Number 2013ECE064M – Gwyneth Zimmerman

- B3.** Using the above three concepts as your main ideas, draw a concept map of how they inter-relate. In your concept map include other subordinate ideas, from the concepts provided in B1 and from your own practice that you would bring into your teaching of electric circuits.

Draw your concept map here



Page 8 of 17

B3: Why do you think it is important for students to learn about electric circuits?

Write your response here:

Category C - What is difficult to teach?

- C1.** What **three** electric circuit concepts, in your experience, are the most difficult to present effectively to students and what do you think the reason for this is? Some **examples** are provided, which you may use as a basis for your response or **give your own ideas**. (**Only give reasons for 3 concepts, either using the ones given or your own**)

Fill in your response in the table below

Concept 1 – Energy in circuits	Reason.....
Concept 2 – Ohm Law, the relationship between voltage and current	Reason.....
Concept 3 – Electric circuits as a system	Reason.....
Concept 4 – Resistors in a parallel connection reduced the total resistance	Reason.....

Masters research project – Protocol Number 2013ECE064M – Gwyneth Zimmerman

Concept 5 – What is meant by voltage	
Concept 6 –	
Concept 7 –	
Concept 8 –	

C2. Physics terminology is quite precise and presents difficulties for students. Which two terms in circuits pose the most difficulty for students and please give a reason for your selection

Term 1	Reason:
Term 2	Reason:

Category D – Representations

D1. Below are three possible representations for teaching the concept of current in a parallel connection are provided. Complete the table below by describing what you like and dislike about each representation and why one representation is better than another.

Representation 1

The total current in a parallel circuit

The current that comes from the battery is the total current. This total current splits up, and part of the current goes through each branch. You can make string-loop models of parallel circuits, as you see in Figure 64 and Figure 65.

Figure 64 A model of a parallel circuit with two branches.

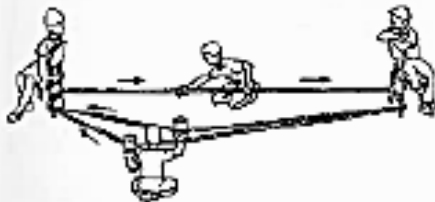
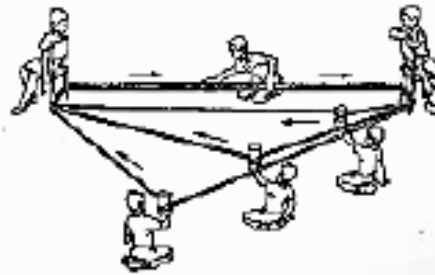

Figure 65 A model of a parallel circuit with three branches.



Science for All Grade 9 Learner's Book (Pg 35)

Representation 2

Water Analogy:

4. When the water flow (or charge flow) is divided into two or more separate pathways (as in a parallel circuit) the sum of the current in each individual pathway equals the total current. Utilize this principle to fill in the blanks in the following two diagrams. The meters in the diagrams are measuring water flow rate in gallons per minute ("gpm").

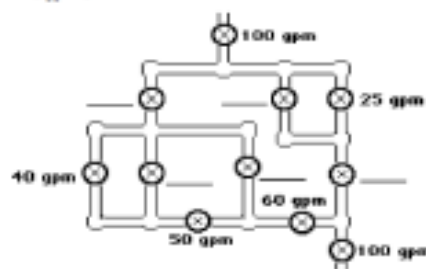
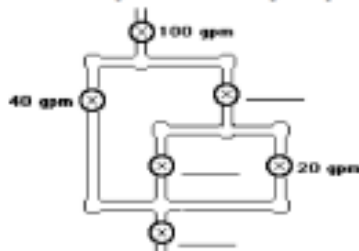

5. Apply the same principle to fill in the blanks in the following diagrams for charge flow (i.e., current) through a parallel circuit.



http://www.windows2universe.org/physical_science/physics/electricity/images/circuit_analogy_water_nipses_sm.jpg

Representation 3

Influencing the Flow Rate on a Tollway

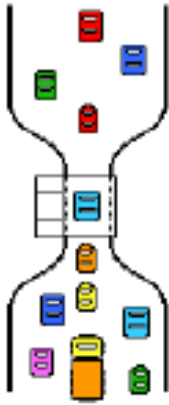

A Single Resistor

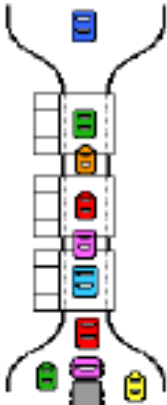

Three Resistors Placed in Series



Three Resistors Placed in Parallel

	What I like and why	What I dislike and why
Representation 1		
Representation 2		
Representation 3		

Masters research project - Protocol Number 2013ECE064M - Gwyneth Zimmerman

D2. Which one of above three representations did you like the most and how would you use it in a lesson

Representation I liked the most	How would you use the representation selected in a lesson?

Category E - Conceptual Teaching strategies

- E1. Study the student's answers to a classroom activity below. Read through her answers and describe what strategies you would employ to assist the student. The student has given a mix of incorrect and correct responses.

The student responses are given in *bold italic*

Activity

The following diagram represents Sparky who departs the cell full of energy. Answer the following questions with reference to the diagram.

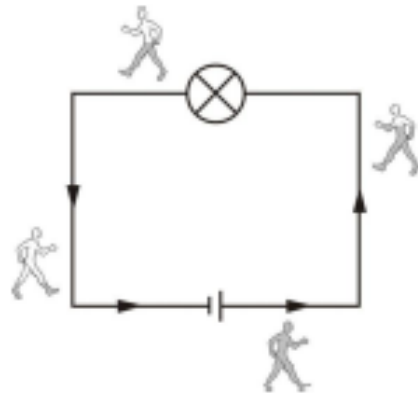

- (a) What is represented by Sparky?

Electricity

- (b) What is represented by the shaded areas in his body?

Current

- (c) Where does Sparky get the energy from?

Battery

- (d) What happens while Sparky moves from the positive terminal to the negative terminal of the cell?

Sparky's charge gets used up

- (e) Is it correct to say that the electric current is used up? Explain your answer.

Yes because as the current moves around the circuit, it gets used for things like heat and light and by the time it gets back to the battery all the current is finished.

Masters research project - Protocol Number 2013ECE064M - Gwyneth Zimmerman

a. What conceptual ideas does this student have in place?

Write your response here

b. What are the key conceptual gaps, in your opinion, that this student demonstrates?

Write your response here

c. What specific strategies would you employ to bridge these gaps?

Write your response here



APPENDIX B: RUBRIC FOR TSPCK ASSESSMENT TOOL

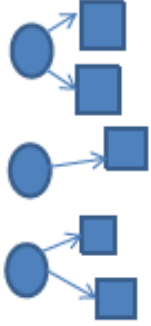
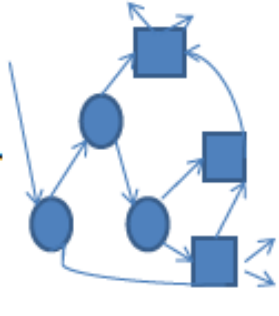

<p>Category A: Learners prior knowledge and misconceptions</p>	<p>A1 - Is the same throughout the circuit A2 - R and I in a parallel circuit</p>	<p>Limited</p> <ul style="list-style-type: none"> No identification/ No acknowledgement/No consideration of student prior knowledge or misconceptions No explanation of concepts Incorrect explanation given 	<p>Basic</p> <ul style="list-style-type: none"> Teacher acknowledges misconception Provide standardized knowledge as definition Repeats standard definition with no expansion <i>E.g. Bulbs are series therefore current is constant throughout</i> No indication of action that the teacher would take
<p>Category B: Planning and Sequencing</p>	<p>B1/B2 - Big Ideas and Sequencing</p>	<p>Developing</p> <ul style="list-style-type: none"> Teacher acknowledges misconception or prior knowledge and provides correct explanation to confront misconception Provide standardized knowledge as definition and/or expands and re-phrase explanation with a single level <i>E.g. I would explain that</i> 	<p>Exemplary</p> <ul style="list-style-type: none"> Teacher acknowledges misconception and provides a correct explanation to confront misconception Provide standardized knowledge as definition and/or Expands and re-phrases explanation with a multi-level approach. <i>Eg Makes use of conservation of particles or fields in explanation. Not just a single approach</i> Explanation demonstrates conceptual understanding
		<p>Basic</p> <ul style="list-style-type: none"> Identifies 2 Big Idea Sequencing can be followed but has at least one illogical placing of key concepts (Big Ideas). Reasons given for sequence unclear or lacks logic. <i>E.g. Need to know what resistance is before the rest can be taught</i> 	<p>Developing</p> <ul style="list-style-type: none"> Identifies at least 2 or 3 Big Ideas Provides a logical sequence for the concepts. Reasons given for sequence are logical in terms of content or learner's level Sequencing is linear: it follows only one concept through and makes no links to other concepts <i>E.g. For current to flow a 'closed' path is need from + battery to the - end of the battery</i>
		<p>Basic</p> <ul style="list-style-type: none"> Only subordinate ideas or 1 Big Idea Identified Sequencing no value due to mixed concepts or no sequence provided at all <p>Big Ideas (any 3 from list below)</p> <ol style="list-style-type: none"> To obtain an electric current there needs to be a continuous loop from one battery terminal to the other terminal An electric current is the net flow of charge. A battery provides the energy for an electric current When there is a current, energy flows from the battery to the external circuit. A battery creates an electric field within the materials that make up the circuit. The electric field is the cause of current flow. An electric circuit is a system in which changes in one part can affect other parts 	<p>Exemplary</p> <ul style="list-style-type: none"> Identifies at least 3 Big Ideas Provides logical sequence for all three Big Ideas with correct and logical reasons Sequencing links the Big Ideas to multiple concepts. <i>E.g. Once learners see a circuit as a system you can then explain how charge 'flows' in the system and introduce concepts of rate of flow of charge and potential difference</i>

	<ul style="list-style-type: none"> Identified subordinate ideas mixed with those Big Ideas of other topics Not all Big ideas have subordinate ideas Identified subordinate ideas mainly incorrect or repetitions of Big Ideas Response lacks logic No linking words 	<ul style="list-style-type: none"> Not all Big ideas have subordinate concepts identified. However those identified are correct Some Subordinate concepts used as starting point Some subordinate ideas relate to Big Ideas Subordinate ideas are limited to algorithms or standard definitions There are few connections between concepts and connections not always correct 	<ul style="list-style-type: none"> Identifies subordinate ideas and shows links to Big ideas with no additional information Uses 2 or 3 Big Ideas as a starting point Subordinate ideas relate to Big ideas on map Identified subordinate ideas include applications of equations and concepts Evidence of linking of at least two concepts Concept map has several connections to subordinate ideas, which are correct. 	<ul style="list-style-type: none"> Identifies subordinate ideas and explains/shows Links Uses only Big ideas as a starting points Subordinate ideas relate to Big ideas on map includes pre-concepts Identified subordinate ideas focus on understanding concepts underlying equations and concepts Cross links shown where applicable Differentiates clearly and correctly be main, subordinate ideas and minor concepts. Has a logical sequences and visually illustrates the 'circuit' nature of electrical concepts. 	<p>B3 (a) - concept map</p>	<ul style="list-style-type: none"> Reasons limited to a general statement One reasons given or gives a general statement such as " has important applications in ..." 	<ul style="list-style-type: none"> Identifies the importance as a topic related to aspects, application and motivation/interest and gives a reason for one aspect <i>E.g. Electricity is a vital part of everyday life. It is important for students know how circuits works so that they can use electricity safely</i> 	<ul style="list-style-type: none"> Identifies the importance as a topic related to aspects, application and motivation/interest and gives reasons for both aspects <i>E.g. These are systems used in their everyday lives, so it is important to have a basic understanding of how they work and the effects of circuits and it is a key part of the final matrix exam</i> 	<ul style="list-style-type: none"> Reasons given include three considerations, application, motivation and interest and conceptual considerations such as scaffolding/sequential development of understanding for other subsequent topics
					<p>B3 (b) - Why is it important?</p>				

<p>Category E: Conceptual teaching strategies</p>	<p>E1 - Sparky</p>	<ul style="list-style-type: none"> • Incorrectly identifies of student prior knowledge and misconceptions • Strategy to confront misconceptions not included or limited E.g. Differentiate between charge, energy and current 	<ul style="list-style-type: none"> • Identifies student prior knowledge and Misconceptions. • Strategy to confront misconceptions limited 	<ul style="list-style-type: none"> • Considers confirmation/confrontation of student prior knowledge and/or common misconceptions • Strategy includes a clear plan for the explanation, which is correct yet basic E.g. I would label all the parts and then talk through Sparky's journey with the student, from when sparky leaves the cell to when he returns to the cell. Use the correct terminology 	<ul style="list-style-type: none"> • Considers prior knowledge and/or common misconceptions • Strategy is multifaceted it includes more than one possible strategy e.g. an analogy, demonstration E.g. Use of the traffic analogy (petrol as source of energy) cars as particles that move to show that the number of cars going from point A to B does not change. Then set up a simple circuit with an ammeter to measure current at different points in the circuit • There is evidence of self-reflection in their description of their strategy
--	---------------------------	--	---	--	--

APPENDIX C: FINAL CONTENT KNOWLEDGE ASSESSMENT TOOL

Masters research project – Protocol Number 2013ECE064M – Gwyneth Zimmerman



University of the Witwatersrand Private Bag 3 Wits 2050 Johannesburg SA t+27 11 7173405 f+27867263424









Electric Circuit Content Tool

The purpose of this research is to find the difficulties and strategies teachers' use when teaching Electric circuits at the Grade 10 level. The assessment instrument consists of two parts; (i) Electric circuit content tool and (ii) Electric circuit Topic Specific Pedagogical Content Knowledge tool

The information will be used for research purposes only: your responses will be treated confidentially. Codes will be used to protect your identity.

Instructions

1. Please fill in the demographic information on the TSPCK instrument
2. Answer all the question on the answer sheet provided.
3. The questions are in the form of multiple-choice items. Please indicate the option you feel is the most correct with a cross
4. Each item also has a confidence level where you indicate how sure you are of your answer.
5. All light bulbs, resistors, and batteries should be considered identical unless you are told otherwise.
6. The battery is to be assumed ideal, that is to say, the internal resistance of the battery is negligible.
7. In addition, assume the wires have negligible resistance.
8. Below is a key to the symbols used on this test.

		 Resistor	 Open
		 Light Bulb in socket	 Closed Switches

1

Masters research project – Protocol Number 2013ECE064M – Gwyneth Zimmerman

Answer Sheet

	<i>MC Item Answer</i>					<i>Confidence Level of Answer</i>			
1	A	B	C	D	E	Blind guess	A bit unsure	Confident	Completely sure
2	A	B	C	D	E	Blind guess	A bit unsure	Confident	Completely sure
3	A	B	C	D	E	Blind guess	A bit unsure	Confident	Completely sure
4	A	B	C	D	E	Blind guess	A bit unsure	Confident	Completely sure
5	A	B	C	D	E	Blind guess	A bit unsure	Confident	Completely sure
6	A	B	C	D	E	Blind guess	A bit unsure	Confident	Completely sure
7	A	B	C	D	E	Blind guess	A bit unsure	Confident	Completely sure
8	A	B	C	D	E	Blind guess	A bit unsure	Confident	Completely sure
9	A	B	C	D	E	Blind guess	A bit unsure	Confident	Completely sure
10	A	B	C	D	E	Blind guess	A bit unsure	Confident	Completely sure
11	A	B	C	D	E	Blind guess	A bit unsure	Confident	Completely sure
12	A	B	C	D	E	Blind guess	A bit unsure	Confident	Completely sure
13	A	B	C	D	E	Blind guess	A bit unsure	Confident	Completely sure
14	A	B	C	D	E	Blind guess	A bit unsure	Confident	Completely sure
15	A	B	C	D	E	Blind guess	A bit unsure	Confident	Completely sure
16	A	B	C	D	E	Blind guess	A bit unsure	Confident	Completely sure
17	A	B	C	D	E	Blind guess	A bit unsure	Confident	Completely sure
18	A	B	C	D	E	Blind guess	A bit unsure	Confident	Completely sure
19	A	B	C	D	E	Blind guess	A bit unsure	Confident	Completely sure
20	A	B	C	D	E	Blind guess	A bit unsure	Confident	Completely sure

Masters research project – Protocol Number 2013ECE064M – Gwyneth Zimmerman

Questions

- Are charges used up in a light bulb, being converted to light?
 - Yes, charges moving through the filament produce “friction” which heats up the filament and produces light.
 - Yes, charges are emitted.
 - No, charge is conserved. It is simply converted to another form such as heat and light.
 - No, charge is conserved. Charges moving through the filament produce “friction” which heats up the filament and produces light.

- How does the power delivered to resistor A change when resistor B is added as shown in circuits 1 and 2 respectively

- Increases
- Decreases
- Stays the same

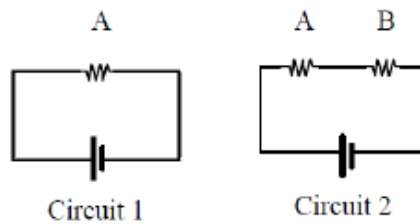

- Consider the circuits shown below. Which circuit or circuits have the greatest energy delivered to it per second?

- Circuit 1
- Circuit 2
- Circuit 3
- Circuit 1 = Circuit 2
- Circuit 2 = Circuit 3

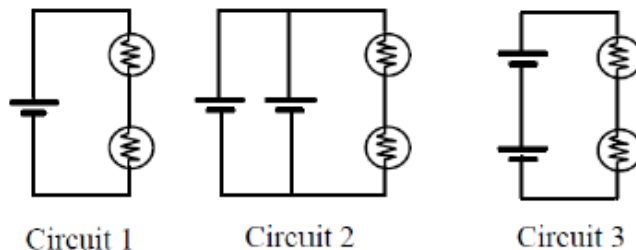

- Compare the resistance of branch 1 with that of branch 2. A branch is a section of a circuit. Which has the least resistance?

- Branch 1
- Branch 2
- Neither, they are the same

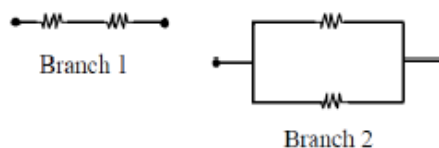

Masters research project – Protocol Number 2013ECE064M – Gwyneth Zimmerman

5. Consider the following circuits

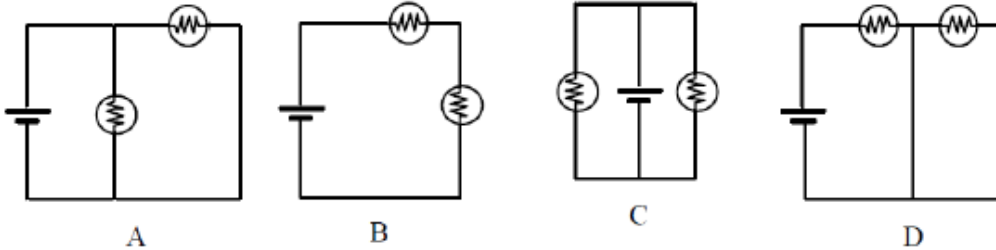

Which circuit/s above represent(s) a circuit consisting of two light bulbs in parallel with a battery?

- A. A
- B. B
- C. C
- D. A and C
- E. A, C and D

6. Rank the potential difference between points 1 and 2, points 3 and 4 and points 4 and 5 in the circuit shown below from highest to lowest

- A. 1 and 2; 3 and 4; 4 and 5
- B. 1 and 2; 4 and 5; 1 and 2
- C. 3 and 4; 4 and 5; 1 and 2
- D. 3 and 4 = 4 and 5; 1 and 2
- E. 1 and 2; 3 and 4 = 4 and 5

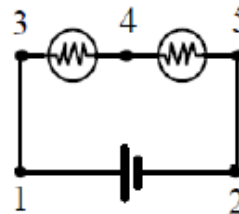

7. Compare the current at point 1 with the current at point 2. Which point has the larger current?

- A. Point 1
- B. Point 2
- C. Neither, they are the same

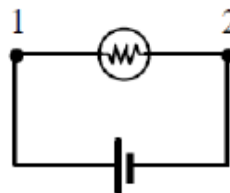

Masters research project – Protocol Number 2013ECE064M – Gwyneth Zimmerman

8. Compare the brightness of bulbs A and B in circuit 1 with the brightness of bulb C in circuit 2. Which bulb or bulbs are the brightest?

- A. A
- B. B
- C. C
- D. A = B
- E. A = C

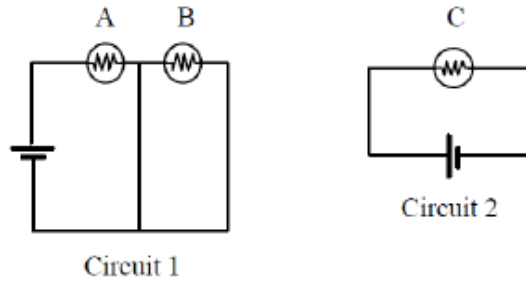

9. Why do the lights in your home come on almost instantaneously?

- A. Charges are already in the wire. When the circuit is completed, there is a rapid rearrangement of surface charges in the circuit.
- B. Charges store energy. When the circuit is completed, the energy is released.
- C. Charges in the wire travel very fast.
- D. The circuits in a home are wired in parallel. Thus, a current is already flowing.

10. Consider the power delivered to each of the resistors shown in the circuits below. Which circuit or circuits have the least power delivered to it/them?

- A. Circuit 1
- B. Circuit 2
- C. Circuit 3
- D. Circuit 1 = Circuit 2
- E. Circuit 1 = Circuit 3

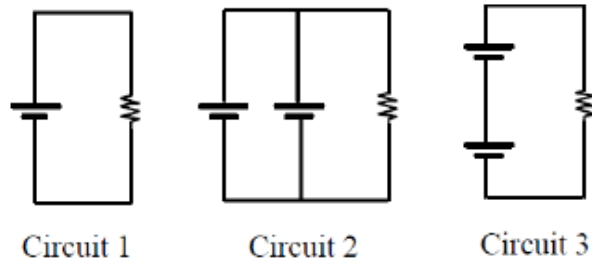

11. How does the resistance between the endpoints change when the switch is closed?

- A. Increases
- B. Decreases
- C. Stays the same

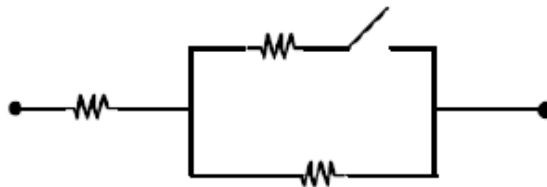

Masters research project – Protocol Number 2013ECE064M – Gwyneth Zimmerman

12. Which schematic diagram best represents the realistic circuit shown below?

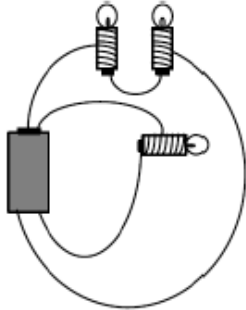

- A. A
- B. B
- C. C
- D. D
- E. None of the above

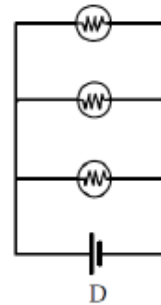
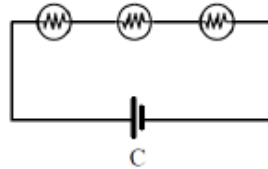
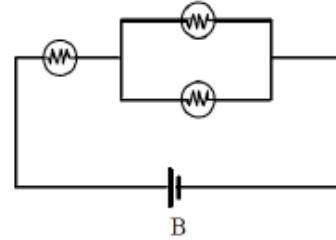
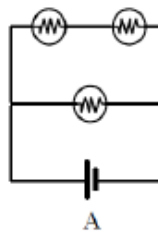

13. What happens to the potential difference between points 1 and 2 if bulb A is removed?

- A. Increases
- B. Decreases
- C. Stays the same

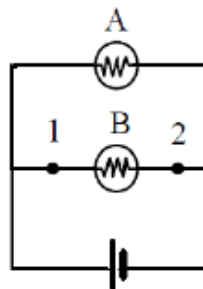

14. Compare the brightness of bulb A in circuit 1 with bulb A in circuit 2. Which bulb is dimmer?

- A. Bulb A in circuit 1
- B. Bulb A in circuit 2
- C. Neither, they are the same

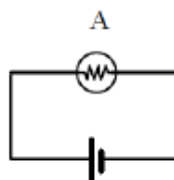

Circuit 1

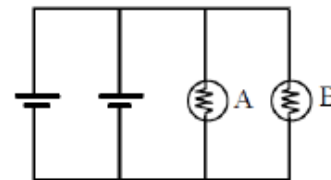

Circuit 2

Masters research project – Protocol Number 2013ECE064M – Gwyneth Zimmerman

15. Rank the currents at points 1, 2, 3, 4, 5, and 6 from highest to lowest.

- A. 5, 1, 3, 2, 4, 6
- B. 5, 3, 1, 4, 2, 6
- C. 5 = 6, 3 = 4, 1 = 2
- D. 5 = 6, 1 = 2 = 3 = 4
- E. 1 = 2 = 3 = 4 = 5 = 6

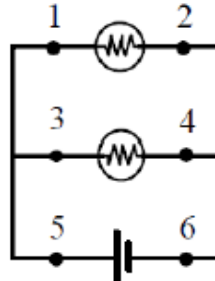

16. Compare the energy delivered per second to the light bulb in circuit 1 with the energy delivered per second to the light bulbs in circuit 2. Which bulb or bulbs have the least energy delivered to it/them per second?

- A. A
- B. B
- C. C
- D. B = C
- E. A = B = C

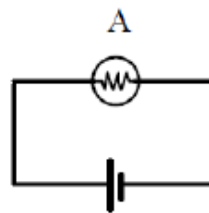

Circuit 1

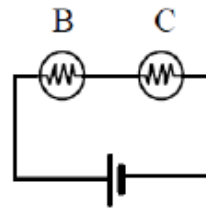

Circuit 2

17. Immediately after the switch is opened, what happens to the resistance of the bulb?

- A. The resistance increases.
- B. The resistance decreases.
- C. The resistance stays the same.
- D. The resistance goes to zero.

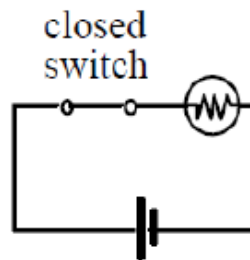

APPENDIX D: CONTENT TOOL MEMORANDUM

Masters research project – Protocol Number 2013ECE064M – Gwyneth Zimmerman

Answer Sheet

	<i>MC Item Answer</i>					<i>Confidence Level of Answer</i>			
	A	B	C	D	E	Blind guess	A bit unsure	Confident	Completely sure
1	A	B	C	D	E	Blind guess	A bit unsure	Confident	Completely sure
2	A	B	C	D	E	Blind guess	A bit unsure	Confident	Completely sure
3	A	B	C	D	E	Blind guess	A bit unsure	Confident	Completely sure
4	A	B	C	D	E	Blind guess	A bit unsure	Confident	Completely sure
5	A	B	C	D	E	Blind guess	A bit unsure	Confident	Completely sure
6	A	B	C	D	E	Blind guess	A bit unsure	Confident	Completely sure
7	A	B	C	D	E	Blind guess	A bit unsure	Confident	Completely sure
8	A	B	C	D	E	Blind guess	A bit unsure	Confident	Completely sure
9	A	B	C	D	E	Blind guess	A bit unsure	Confident	Completely sure
10	A	B	C	D	E	Blind guess	A bit unsure	Confident	Completely sure
11	A	B	C	D	E	Blind guess	A bit unsure	Confident	Completely sure
12	A	B	C	D	E	Blind guess	A bit unsure	Confident	Completely sure
13	A	B	C	D	E	Blind guess	A bit unsure	Confident	Completely sure
14	A	B	C	D	E	Blind guess	A bit unsure	Confident	Completely sure
15	A	B	C	D	E	Blind guess	A bit unsure	Confident	Completely sure
16	A	B	C	D	E	Blind guess	A bit unsure	Confident	Completely sure
17	A	B	C	D	E	Blind guess	A bit unsure	Confident	Completely sure
18	A	B	C	D	E	Blind guess	A bit unsure	Confident	Completely sure
19	A	B	C	D	E	Blind guess	A bit unsure	Confident	Completely sure
20	A	B	C	D	E	Blind guess	A bit unsure	Confident	Completely sure

APPENDIX E: PARTICIPANT INFORMATION AND CONSENT LETTER

TSPCK Project Information and Consent Letter

INFORMATION SHEET: TEACHERS

DATE: 16th April 2014

Dear Colleague

My name is Gwyneth Zimmerman, I am a senior science teacher and part-time student in the School of Education at the University of the Witwatersrand, currently doing my Masters degree in Education, with a Science focus.

I am doing research on the 'Design and Validation of an Instrument to Measure Topic Specific Pedagogical Content Knowledge of Electric Circuits of Physical Sciences Teachers'. The purpose of this research is for the partial fulfilment of the Masters degree.

The research involves designing and validating a questionnaire to measure Topic Specific Pedagogical Content Knowledge (TSPCK) and Content Knowledge in electric circuits. Electric circuits are a component of most Physics curricula at multiple grade levels. The concepts and terminology involved in electric circuits are problematic for many students. Electricity is part of the everyday life of most students but this familiarity can lead to the reinforcing of misconceptions. The instrument is aimed at the concepts that would be covered at the Grade 10 level as this forms the conceptual framework for more complex topics at the higher grades. Experienced practicing teachers often have the ability to transform content knowledge in such a way when teaching electric circuits in order to help learners understand the necessary concepts. Therefore, measuring topic specific PCK of experienced teachers can be used to support less experienced teachers through professional development programmes in developing PCK and ultimately assist learners to gain a better understanding of circuits.

I would really appreciate your expertise and input by completing the Topic Specific PCK questionnaire (TSPCK). Completing the questionnaires should take approximately an hour of your time. I am grateful for your willingness to give of your time and experience.

Your name and identity will be kept confidential at all times and in all academic writing, including my final research report, in conference proceedings and any journal articles about the study. Your individual privacy will be maintained in all published and written data resulting from the study.

All research data will be destroyed within 3-5 years after completion of the project.

You will not be advantaged or disadvantaged in any way. You may however benefit by finding ways to incorporate the knowledge gained to improve your teaching practice or find ways to assist less experienced teachers that have to teaching stoichiometry in the new curriculum for the first time. Your participation is voluntary, so you can withdraw your permission at any time during this project without any penalty. There are no foreseeable risks in participating and you will not be paid for this study.

Your completed form can either be emailed back to me, or I can come at collect it when it is convenient for you.

Please let me know if you require any further information.
Thank you very much for your help.

Yours sincerely,

SIGNATURE

NAME: Gwyneth Jean Zimmerman
ADDRESS: 897 Alverstoke Ave Strubensvalley
EMAIL: gwynethzimmerman1@gmail.com
TELEPHONE NUMBERS: 071 202 3468

TSPCK Project Information and Consent Letter

Teacher's Consent Form: Questionnaire

Please fill in and return the reply slip below indicating your willingness to fill in the questionnaire for my voluntary research project called: 'The Design and Validation of an Instrument to Measure Topic Specific Pedagogical Content Knowledge in Electric Circuits of Physical Sciences Teachers'.

Permission for the use of questionnaires

I, _____

Give/do not give * my consent to fill in these questionnaires.

- I know that my participation is voluntary and that I may withdraw from the study at any time and that I will not be advantaged or disadvantaged in any way.
- I know that I can decline to answer a specific question and that I understand I have the right to review the questionnaires I complete before these are used for analysis if I so choose. I can delete or amend any material or retract or revise any of my remarks.
- I am aware that the researcher will keep all information confidential in all academic writing and that results will be reported so that my identity is anonymous.
- I understand that the results of the study may be published, but my identity will be anonymous.
- I am aware that my questionnaires will be destroyed between 3—5 years after the completion of the project.

Teacher Signature:

Date:

I would like to thank you in advance for your time and your voluntary participation.

Contact person:

NAME: Gwyneth Jean Zimmerman
ADDRESS: 897 Alverstoke Ave, Strubensvalley
EMAIL: gwynethzimmerman1@gmail.com
TELEPHONE NUMBERS: 071 202 3468

APPENDIX F: INFORMATION AND MEMORANDUM GIVEN TO TEACHERS AFTER COMPLETION OF ASSESSMENT TOOLS

Misconceptions in Electric Circuits

Hammer defined a misconception as *stable cognitive structures to be changed that affect students' understanding of scientific concepts and must be overcome so that students learn scientific concepts effectively.* (Hammer, 1996)

Below is a summary of some the common misconceptions found in the process of learning electric circuits

Misconception	Description
'attenuation model' - Current is used up	It is intuitive for students to think that current is consumed because charge is 'used up'. After all, they commonly hear that a 'dead' battery must be 're-charged'; therefore it must have become 'empty'. (Wainwright, 2007)
'power supply as constant current source' or 'voltage in Closed Circuits - Batteries deliver a fixed amount of current regardless of cell components	Even after instruction students use the voltage concept as having approximately the same properties as the current concept. They tend to think of a battery as a source of constant current rather than a source of constant voltage. (Wainwright, 2007)
'sequential model' - A change in a circuit only affects the components after the component.	Assuming that what occurs 'downstream' in the circuit cannot affect 'upstream' components of the circuit, again failing to recognize the circuit as a system. (Wainwright, 2007)
'empirical rule model' - The further away a bulb is away from the battery the dimmer it will be	
'short circuit' - Wires with no circuit components can be ignored when analysing a circuit	
'parallel circuit misconceptions' - Increase of resistors in parallel increases the overall resistance	Most students have difficulty with the inverse/non-additive effect of resistors in parallel. (Wainwright, 2007)
'local reasoning' - Circuit not viewed as a system. Any change only affects the component being changed and not the whole circuit	This phenomenon occurs when students focus on what is occurring at only one point within the circuit without considering the circuit as an interrelated system. A student may assume, for example, that once current reaches a junction, it must divide equally into each branch. (Wainwright, 2007)
'battery origin' - Battery a source of charges that are pumped out rather than being recycled	Many students assume that the battery is the source of mobile charge (current) in a circuit – that charges are pumped out of a supply within the battery rather than recycled. (Wainwright, 2007)
'inter-changeability of terms' - Voltage, current, power charges, energy, used as one property	Some students have difficulty understanding the effect of changing resistance in a circuit, considering the battery to be a constant current source. (Wainwright, 2007)
'clashing model' - Current from the positive and negative terminal meet at the circuit component	An assumption that current must be released from both ends of a battery, and that bulbs light when current moves through them in both directions. For example, many students believe a single bulb will light if connected to a cell with one wire; adding a second wire just supplies it with more current. (Note: this model was not included in the Content Tool because it is uncommon)

'shared current model' - Current is shared equally with all circuit components	
'current as water flow' - Current strongest in a straight path. A bend in the wire decreases current strength	

Memo

Question	Answer	Misconception	Comment – if the student answers incorrectly
1.	D	i. Attenuation model	<ul style="list-style-type: none"> Charges are seen as particles that have energy. There is connection between this concept and the material covered in 'Particle Model' in the earlier grades
2	B	i. Power supply as a constant current source ii. Local Reasoning iii. Shared current model	<ul style="list-style-type: none"> The student presumes that because the battery is the same, the same current is delivered The impact of the second resistance viewed as not having an impact because it is placed after the resistor A (using conventional current). The student doesn't view the circuit as a whole system and doesn't see that a change anywhere in the circuit impacts the entire circuit. Students will also need to know that $P = VI$ and that increased resistance means decreased current
3.	C	i. Inter-changeability of terms ii. Parallel circuit misconceptions iii. Power supply as a constant current source	<ul style="list-style-type: none"> Students will need to know that the question is asking for voltage (J/s) and that the resistance in all the circuits is the same Students will need to see the cells connected in parallel will produce the same voltage as the single cell Students may be confused with the way the two cells in series are drawn
4	B	i. Parallel circuit misconceptions	<ul style="list-style-type: none"> Student who don't understand the impact of resistors in series would most likely answer C
5.	D	i. Parallel circuit misconceptions	<ul style="list-style-type: none"> Most students would be able to select A but miss that C is also parallel because the current has two possible pathways
6.	E	i. Local Reasoning ii. Power supply as a constant current source	<ul style="list-style-type: none"> Between points 1 and 2 the total V is being measured and across the light bulbs this will be less than the total V but equal to each other. Students need to understand the circuit as a whole system
7.	C	i. Sequential Model ii. Local Reasoning iii. Current as water flow	<ul style="list-style-type: none"> This a common misconception, where students think current gets 'used up' as it moves through a light bulb. They don't see current as constant through a series circuit. They muddling up concepts of current flow and energy transformation If students think about current as water flow, the idea is

			the 'water' somehow 'dams' up behind the light bulb and that is why the current drops the light bulb
8.	E	i. Short circuit	<ul style="list-style-type: none"> The connecting wire between A and B provides a much lower resistance pathway so current wouldn't flow through B – effectively cutting it out of the circuit. Students will overlook the impact of the connecting wire and just focus on the bulbs
9.	A	i. Battery origin ii. Attenuation iii. Local Reasoning	<ul style="list-style-type: none"> Charges are not seen as the same particles that make up material. Some external sources is seen as the 'producer' of charges. The explanation is given that when the battery 'runs out' of charges the battery is flat. Connecting wires are seen as empty channels and not part of the whole system that makes up the circuit
10.	D	i. Inter-changeability of terms ii. Parallel circuit misconceptions iii. Power supply as a constant current source	<ul style="list-style-type: none"> Similar to Question 3. Student will need to know that the voltage delivered in Circuits 1 and 2 are the same but less than 3, so using $P = VI$ Circuits 1 and 2 will have the lower power rating
11.	B	i. Parallel circuit misconceptions	<ul style="list-style-type: none"> Students struggle with the idea that adding a resistor can have the effect of dropping the overall resistor, if it is added in parallel
12.	A	i. Parallel circuit misconceptions	<ul style="list-style-type: none"> It is sometime difficult for students to see the two possible pathways in the realistic circuit. Students often struggle when there is a mix of parallel and series. Being able to translate the realistic from to the schematic shows an understanding of how a circuit is constructed
13.	C	i. Local reasoning ii. Inter-changeability of terms	<ul style="list-style-type: none"> Students need to recognise that because there are no other cell components in the circuit the voltage of the battery is the same as the voltage across the resistors, regardless of how the resistors are arranged. Students who answer B (decreases) are most likely interchanging concepts of voltage and current
14.	C	i. Parallel circuit misconceptions	<ul style="list-style-type: none"> Students will first need to see voltage delivered is the same for both circuits The addition light bulb in parallel, in Circuit 2, will have the effect of halving the total resistance and therefore doubling the total current but when the current splits at the parallel connects it halves again so the net effect on current in the parallel branches is the same as Circuit 1
15.	D.	i. Parallel circuit misconceptions ii. Sequential model iii. Attenuation	<ul style="list-style-type: none"> Current at 5 and 6 represents the total current and they are equal – current isn't 'used up' Current in the parallel branches is equal and the same after the light bulbs

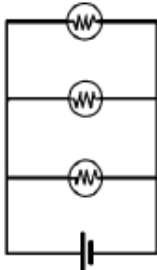
16.	D	<ul style="list-style-type: none"> i. Local Reasoning ii. Inter-changeability of terms 	<ul style="list-style-type: none"> • The total V delivered is the same for both circuits but the available energy has to be split between two bulb equally
17.	C	<ul style="list-style-type: none"> i. Inter-changeability of terms. ii. Local reasoning 	<ul style="list-style-type: none"> • Resistance is a property of the materials used • Current changes as a result of resistance and not the other way round
18.	D	<ul style="list-style-type: none"> i. Local reasoning ii. Inter-changeability of terms 	<ul style="list-style-type: none"> • The components and how they inter-relate is key to understanding circuits. The batter delivers and creates a fields. • How energy is converted is a function of the components in the circuit.
19.	D	<ul style="list-style-type: none"> i. Local ii. reasoning 	<ul style="list-style-type: none"> • Students sometimes battle to see that even if no current is flowing the battery still has a voltage reading. This forms the basis for understanding emf and internal resistance that is covered in the higher grades
20.	B	<ul style="list-style-type: none"> i. Parallel circuit misconceptions 	<ul style="list-style-type: none"> • The connecting wires have negligible resistance – Question 20 diagram is the same as the diagram below and then it is easy to see that the current would divide evenly three ways. <div style="text-align: center;">  </div>

References

Engelhardt, P., & Beichner, R. (2004, January). Students’ understanding of direct current resistive electrical circuits. *American Journal of Physics*, 72, 98 -115.

Hammer, D. (1996). More than misconceptions. Multiple perspectives on student knowledge and reasoning and an appropriate role for education research. *American Journal of Physics*, 64, 1316 - 1325.

Pesman, H., & Eryilmaz, A. (2010). Development of a three-tier test to assess misconceptions about simple electric circuits. *The Journal of Educational Research*, 103, 208 -222.

Wainwright, C. (2007). *Toward Learning and Understanding Electricity: Challenging Persistent Misconceptions*. Retrieved 2013, from Pacific University: <http://fg.ed.pacificu.edu/wainwright/index.html>

Some Additional Questions

1. Compare the brightness of the bulb in circuit 1 with that in circuit 2. Which bulb is brighter?

- A. Bulb in circuit 1
- B. Bulb in circuit 2**
- C. Neither, they are the same

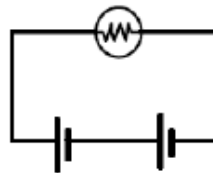

Circuit 1

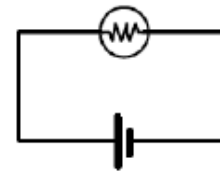

Circuit 2

2. Which circuit(s) will light the bulb?

- A. A
- B. C
- C. D
- D. A and C**
- E. B and D



A



B

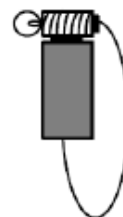

C



D

3. What happens to the brightness of bulbs A and B when a wire is connected between points 1 and 2?

- A. Increases
- B. Decreases
- C. Stays the same**
- D. A becomes brighter than B
- E. Neither bulb will light

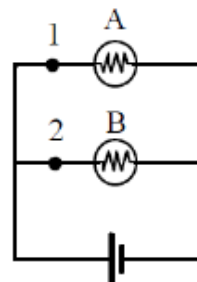

6. Will all the bulbs be the same brightness?

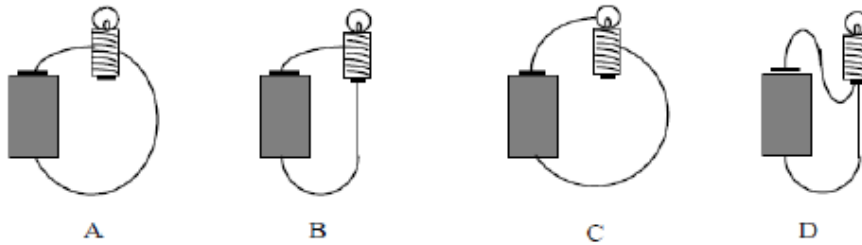

- A. Yes, because they all have the same type of circuit wiring.
- B. No, because only B will light. The connections to A, C, and D, are not correct.**
- C. No, because only D will light. D is the only complete circuit.
- D. No, C will not light but A, B, and D will.

7. What happens to the brightness of bulbs A and B when the switch is closed?

- A. A stays the same, B dims
- B. A brighter, B dims**
- C. A and B increase
- D. A and B decrease
- E. A and B remain the same

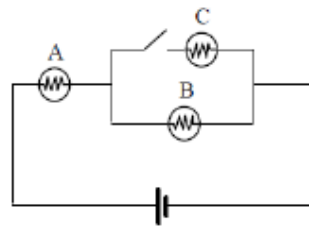

8. Which circuit(s) will light the bulb?

- A. A
- B. B
- C. D**
- D. B and D
- E. A and C

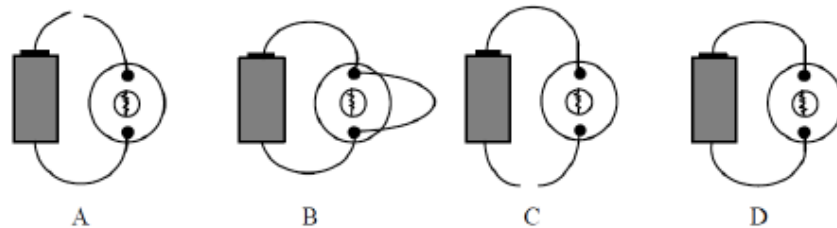

APPENDIX G: ETHICS PERMISSION LETTER

Wits School of Education



27 St Andrews Road, Parktown, Johannesburg, 2193 Private Bag 3, Wits 2050, South Africa
Tel: +27 11 717-3064 Fax: +27 11 717-3100 E-mail: enquiries@educ.wits.ac.za Website: www.wits.ac.za

Student Number:
8807461V
Protocol Number:
2013ECE064M

Date: 04-Jun-2013

Dear Gwyneth Zimmerman

Application for Ethics Clearance: Master of Education

Thank you very much for your ethics application. The Ethics Committee in Education of the Faculty of Humanities, acting on behalf of the Senate has considered your application for ethics clearance for your proposal entitled:

The Design of an Instrument to Measure the Topic Specific Pedagogical Content Knowledge of Physical Science Teachers in Electric Circuits

The committee recently met and I am pleased to inform you that clearance was granted.

Please use the above protocol number in all correspondence to the relevant research parties (schools, parents, learners etc.) and include it in your research report or project on the title page.

The Protocol Number above should be submitted to the Graduate Studies in Education Committee upon submission of your final research report.

All the best with your research project.

Yours sincerely

Matsie Mabeta
Wits School of Education

011 717 3416

CC Supervisor: Prof M Rollnick and Ms. C Steinberg

APPENDIX H: COMPLETED TSPCK ASSESSMENT TOOL

Masters research project – Protocol Number 2013ECE064M – Gwyneth Zimmerman

Electric Circuit TSPCK Instrument

Category A – Typical Student Responses

The two questions below are typical multiple choice items that students have answered incorrectly. A selection of possible teacher responses are provided, none of which are incorrect. Select the response you would most likely use in your practice and explain the reason for your response

A1. How would you comment in writing to the student who selects B as the answer to the question below, where A_1 and A_2 are ammeters

Which one of the following options is correct for the circuit shown below?

- A. $A_2 > A_1$
- B. $A_1 > A_2$
- C. $A_1 = A_2$

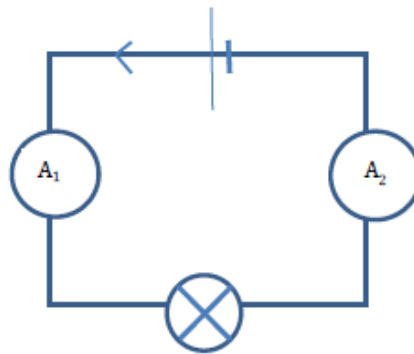

Response A: Keep in mind that this is a series circuit so current is not divided; therefore the correct answer is C. The current is the same throughout the circuit

Response B: Current is the rate of flow of charge. In this case the charge flowing is electrons. Electrons are particles that have mass and cannot disappear as they flow around the circuit. None of the electrons disappear through the circuit so the correct answer is C

Response C: Charged particles move under the influence of the electric field created by the battery, all the charged particles are in the same field, with the easiest path being in the single, undivided conductor. The flow of the charged particles is same throughout, so the correct answer is C

Response D: None of the above

Choose your response, and expand on the reason for your selection in the space provided

My choice is C

My reason is

Answer C provides the best conceptual explanation since the movement of electrons are as a result of an electric field that is established by the battery.

A just states the facts again, and B works with the definition as a starting point.

The reason learners get this wrong is because they don't understand why charge move in a circuit in the first place, and C provides a part explanation for that.

A2. How would you respond verbally to a student who answers B to the following question?

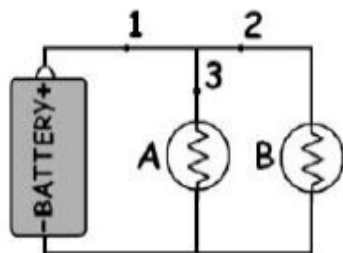

Figure 6

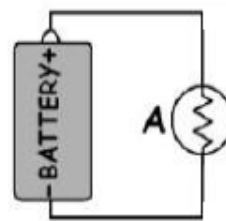

Figure 7

Compare the brightness of Bulb A in Figures 6 and 7.

- A. Brighter in Figure 6
- B. Brighter in Figure 7
- C. The same in the both figures

Response A: Just because there are two light bulbs in figure 6, doesn't mean that A will burn brighter. The brightness is dependent on the amount of current moving through the bulb. In Figure 6 the current has been divided at the parallel connection. The presence of the parallel connection means resistance is halved so current is doubled so the amount of current through the parallel branches, in this case, is the same as through the single bulb so there is no difference in brightness.

Response B: All the bulbs are identical; their brightness is dependent on how efficiently they can transform energy, which is defined by the term power. In electric circuits power can be calculated by $P = VI$. In the parallel connection if we calculate the equivalent resistance of the parallel connection. If we assume a resistance of 2Ω then $\frac{1}{R_T} = \frac{1}{2} + \frac{1}{2}$ which is equal to 1Ω exactly half the overall resistance in Figure 7. Seeing that as voltage stays the same current would be doubled and then halved again at the parallel connection, so the same amount of current is available to be transformed.

Response C: You seem to have missed that the bulbs in figure 6 are connected in parallel. At the parallel connection the current divides. The bulbs have identical resistance so the current will divide equally through both branches. Two bulbs in parallel halves the resistance, which doubles the current, which is then halved again at the parallel connection, so the net effect is zero and bulbs will burn equally bright.

Response D: None of the above

Choose your response, and expand on the reason for your selection in the space provided

My choice is B

My reason is _____

Learners really struggle with questions like these. In an answer like C about halving and doubling and halving again, many learners do not follow your explanation. I think the switch between words and symbols and diagrams all the time is really difficult. In my experience, working with numbers, by putting real values into the circuit, helps learners make it more concrete. Possibly also because one is only working with symbols, so it is easier. I have therefore chosen B. It also brings in power, which is needed to explain brightness. A and C does not talk about power, only R and I.

Category B - Planning and Sequencing

A selection of content and concepts relating to electric circuits is provided. The question below refers to how knowledge and concepts are ranked and how a teacher makes connections between content and concepts.

B1. Review the list of concepts relating to electric circuits below.

Select and rank three foundational concepts, that you regard, as both basic and central concepts in electric circuits.

1. To obtain an electric current there needs to be a continuous loop from one battery terminal to the other terminal
2. An electric current is the net flow of charge.
3. Parallel connection in a circuit are current dividers
4. The materials that make up the circuit provide the charged particles when there is an electric current
5. A battery provides the energy for an electric current
6. Voltage can be defined as $J.C^{-1}$
7. Ohm's law can be expressed as $V = \frac{R}{I}$
8. When there is a current, energy flows from the battery to the external circuit.
9. Resistance is the opposition to current flow
10. A battery creates an electric field within the materials that make up the circuit. The electric field is the cause of current flow.
11. The resistance of a parallel connection can be calculated by $\frac{1}{R_T} = \frac{1}{r_1} + \frac{1}{r_2} + \frac{1}{r_3} \dots$
12. An electric circuit is a system in which changes in one part can affect other parts
13. Power is the rate at which energy is dissipated by the circuit component.
14. Current measured with an ammeter and voltage by a voltmeter

Write the number of the concepts you have selected, in order of importance.

Concepts
Concept 1. An electric circuit is a system in which changes in one part can affect other parts
Concept 2. An electric current is the net flow of charge
Concept 3. A battery creates an electric field within the materials that make up the circuit. The electric field is the cause of current flow.

B2. Using the three selected concepts from B1, give the sequence you would teach them in and your reasons for doing so

Concept	Reason for sequence
<p>An electric circuit is a system in which changes in one part can affect other parts</p>	<p>I would teach the section with the following three questions in mind What is an electric circuit? What is an electric current? What makes a circuit work?/Where does it get its energy from?</p>
<p>An electric current is the net flow of charge</p>	<p>I would therefore start by introducing an electric circuit as a system, a concept which they are familiar with from primary school, and also grade 8 and 9. I would then talk about the different</p>
<p>A battery creates and electric field within the materials that make up the circuit. The electric field is the cause of current flow.</p>	<p>components of a circuit, and the purpose of each. That would lead me to what an electric current is - one of the big ideas in circuits. And then where do the electrons in a current get their energy from.</p>

B3. Using the above three concepts as your main ideas, draw a concept map of how they inter-relate. In your concept map include other subordinate ideas, from the concepts provided in B1 and from your own practice that you would bring into your teaching of electric circuits.

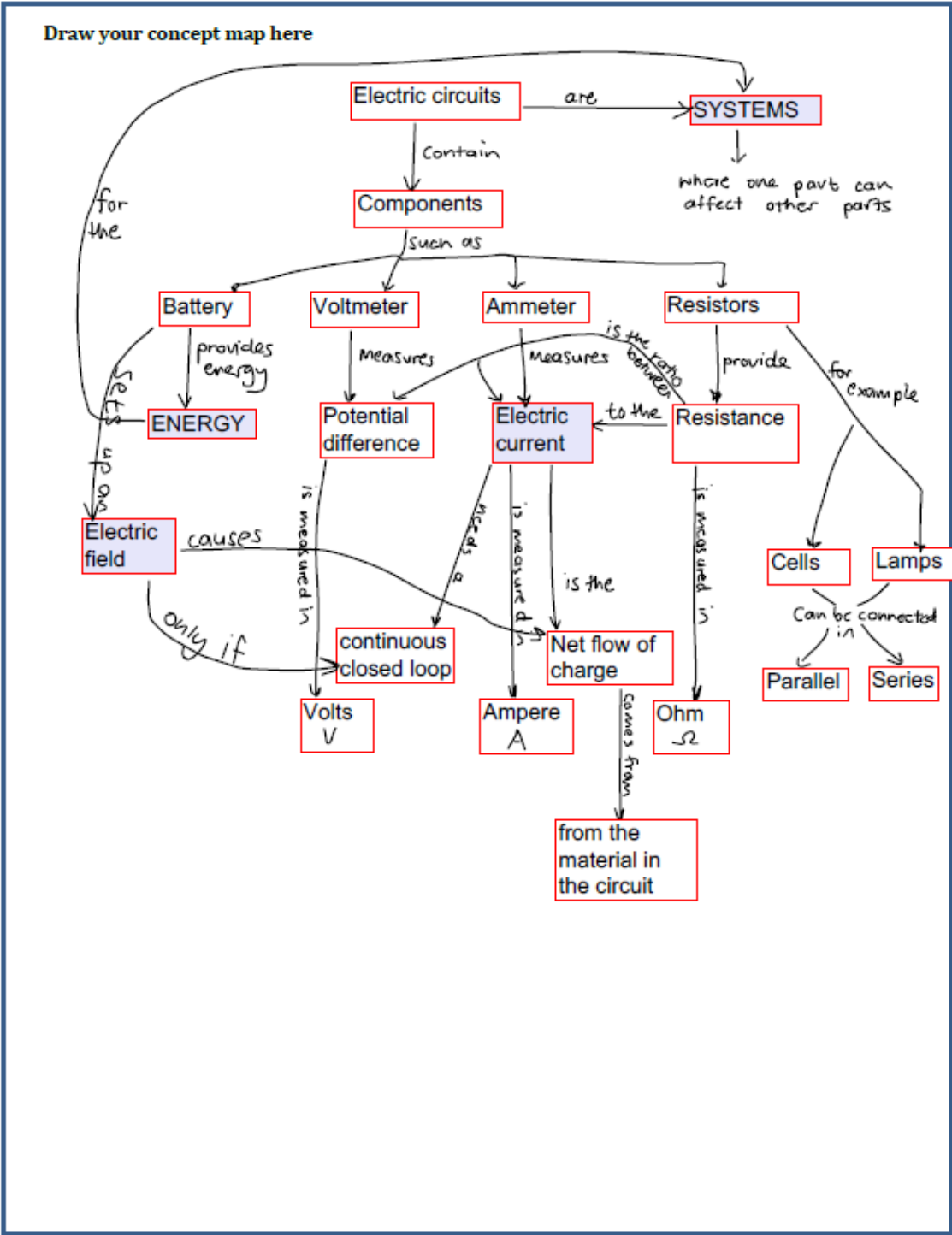

B3: Why do you think it is important for students to learn about electric circuits?

Write your response here:

Electric circuits play an important role in modern life. They supply us with energy in our homes, cars, etc. Learners need to understand that energy is the driving force for life, with no energy, no life is possible. Electric circuits is one way of how we have been able to capture the energy in the universe so that it is useful for us (keep us warm, let us cook food, have light, communicate with others, etc.

Knowledge of electric circuits are also needed for further study at school level, e.g in electric motors or generators, and beyond school e.g electrical engineering.

I also think this is general knowledge that the public should have basic scientific literacy for everyone, especially usefulness and importance/need to have electricity, and the dangers of electricity.

Category C - What is difficult to teach?

C1. What three electric circuit concepts, in your experience, are the most difficult to present effectively to students and what do you think the reason for this is? Some examples are provided, which you may use as a basis for your response or give your own ideas. (Only give reasons for 3 concepts, either using the ones given or your own)

Fill in your response in the table below

<p>Concept 1 - Energy in circuits</p>	<p>Reason..... Energy is a really difficult concept, it is, in my opinion, the most difficult in science. It is not tangible, there is no really good definition for it, yet it is the driving force for life. I am not even sure that I always understand it well, so that makes it very difficult to bring across, especially to learners who want to know more than just 'the facts'.</p>
<p>Concept 2 - Ohm Law, the relationship between voltage and current</p>	<p>Reason.....</p>
<p>Concept 3 - Electric circuits as a system</p>	<p>Reason..... Learners sometimes struggle to see the bigger picture and with systems one needs to be able to see all the bits as a unit, with an input and an output, parts working together. Often circuits are just presented as a bunch of calculations and learners don't understand how the parts fit together.</p>
<p>Concept 4 - Resistors in a parallel connection reduced the total resistance</p>	<p>Reason.....</p>

Masters research project - Protocol Number 2013ECE064M - Gwyneth Zimmerman

Concept 5 - What is meant by voltage	This is a concept that is not well understood, like with energy, I am not sure I always understand it well enough to be able to explain it to others. Often just a definition is given, and shown how to use it in an equation, or to solve a circuit, and that is usually sufficient for most students, but for those who really want to understand,
Concept 6 -	it is not enough. I realised my own uncertainty when I had to explain it to a 10 year old, and I struggled. :-)
Concept 7 -	
Concept 8 -	

C2. Physics terminology is quite precise and presents difficulties for students. Which two terms in circuits pose the most difficulty for students and please give a reason for your selection

Term 1 Energy	Reason: I don't think a 'good' definition which captures the nature of energy is available. Energy cannot be created or destroyed is what is often used, and this still does not tell me what it is.
Term 2 potential difference or voltage	Reason: As explained in the previous section, this is also not well defined, and needs the understanding of other difficult concepts, like field, energy, or joules.

Category D – Representations

D1. Below are three possible representations for teaching the concept of current in a parallel connection are provided. Complete the table below by describing what you like and dislike about each representation and why one representation is better than another.

Representation 1

The total current in a parallel circuit

The current that comes from the battery is the total current. This total current splits up, and part of the current goes through each branch. You can make string-loop models of parallel circuits, as you see in Figure 54 and Figure 55.

Figure 54 A model of a parallel circuit with two branches.

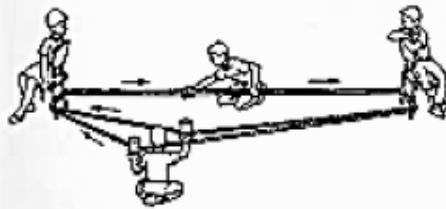
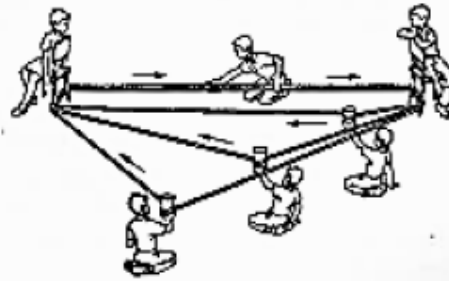

Figure 55 A model of a parallel circuit with three branches.



Science for All Grade 9 Learner's Book (Pg 35)

Representation 2

Water Analogy:

- When the water flow (or charge flow) is divided into two or more separate pathways (as in a parallel circuit) the sum of the current in each individual pathway equals the total current. Utilize this principle to fill in the blanks in the following two diagrams. The meters in the diagram are measuring water flow rates in gallons per minute ("gpm").

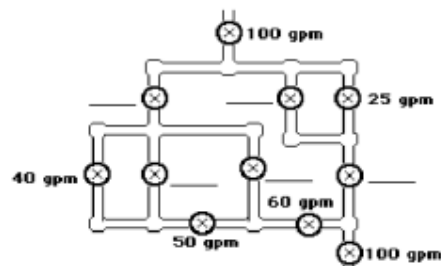
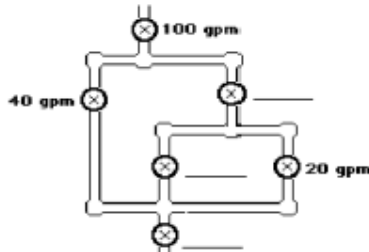

- Apply the same principle to fill in the blanks in the following diagrams for charge flow (i.e., current) through a parallel circuit.

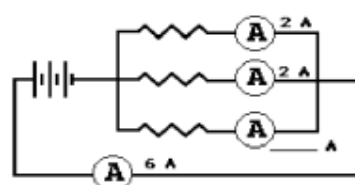
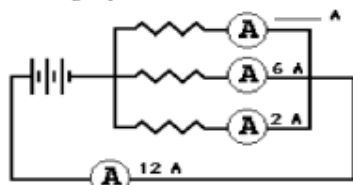

http://www.windows2universe.org/physical_science/physics/electricity/images/circuit_analogy_water_pipes_sm.jpg

Representation 3

Influencing the Flow Rate on a Tollway

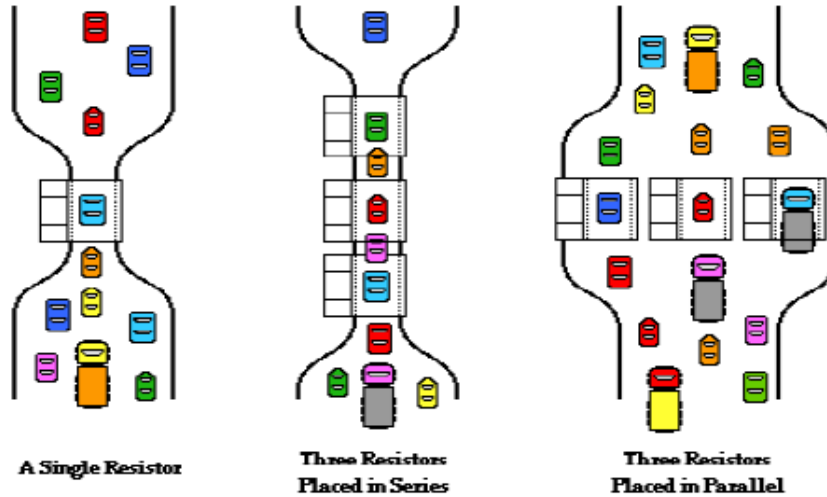

	What I like and why	What I dislike and why
Representation 1	It can help learners follow the path of electrons and 'see' the different options so it makes the abstract a bit more tangible.	Learners might think that charge can 'choose' like people, which way to go.
Representation 2 This is not a bad analogy as it links the water example to a circuit and lets the learners apply their understanding in a new situation. One can also use water to help learners understand if the water pump is switched on in the one side, the water immediately comes out on the other side, just like electrons which are available throughout the circuit.		The water is a bit better than the one above as it does not create the impression that charge can 'choose' which way to go.
Representation 3	This can be useful to explain the flow of charge is like the flow of cars, to get the rate principle across.	Again, electrons, or charge, are not like cars which can choose where to drive, nor do electrons flow in lanes in a circuit, so these might cause further misconceptions.

D2. Which one of above three representations did you like the most and how would you use it in a lesson

Representation I liked the most	How would you use the representation selected in a lesson?
Possible nr 2	<p>I don't really think any analogy in circuits are great, as most of them could introduce further misconceptions, but I have found that the water analogy does work well to help learners understand that charge will flow in the path where there is the least resistance, also flow in all paths but not necessarily in equal amounts, and also split where there are junctions, and come together after the split. It is also useful to get the idea across that when a switch is closed, charge is available everywhere in the circuit at the same time, like water in a pipe, it comes out the one end immediately when the tap is opened.</p>

So in a lesson I might use this in a number of places, as I teach different concepts, and also come back to it at various points in time. I will however also point out that charge is NOT water, and that it is only a useful example to help us understand.

The cars analogy I would rather use to link current with resistance, where a higher current (more cars) flows in a conductor with a lower resistance (wide road).

I have not really used, or seen, the analogy with the children, so I am not sure how learners will understand, or misunderstand it, so I don't know if and how I will use that.

Category E - Conceptual Teaching strategies

- E1. Study the student's answers to a classroom activity below. Read through her answers and describe what strategies you would employ to assist the student. The student has given a mix of incorrect and correct responses.

The student responses are given in *bold italic*

Activity

The following diagram represents Sparky who departs the cell full of energy. Answer the following questions with reference to the diagram.

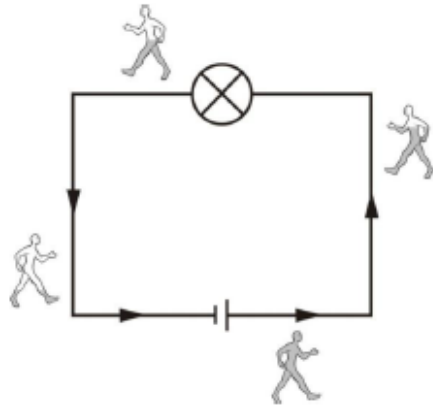

- (a) What is represented by Sparky?

Electricity Electron

- (b) What is represented by the shaded areas in his body?

Current Energy

- (c) Where does Sparky get the energy from?

Battery From the chemical reactions in the cell/battery

- (d) What happens while Sparky moves from the positive terminal to the negative terminal of the cell?

Sparky's charge gets used up Sparky loses energy to the components in the circuit.

- (e) Is it correct to say that the electric current is used up? Explain your answer.

Yes because as the current moves around the circuit, it gets used for things like heat and light and by the time it gets back to the battery all the current is finished.

No, electrical energy is converted to other forms like light (in a lamp) or heat (in a resistor) causing Sparky to lose energy.

Masters research project - Protocol Number 2013ECE064M - Gwyneth Zimmerman

a. What conceptual ideas does this student have in place?

Write your response here

Electricity is what is moving through a circuit.
The battery supplies current to sparky, so the battery produces current which is carried through the circuit.
Like a person who needs energy to move, the electricity also needs energy to go around the circuit and this energy is used up, like people 'use up' energy every day.
The student is confusing electricity, charge and energy. No mention is made of electrons, or energy conversions.

b. What are the key conceptual gaps, in your opinion, that this student demonstrates?

Write your response here

Fundamentally the learner does not understand what current is and how it is able to flow through a circuit.
The battery has chemical compounds in it which provides electrons with energy (converted from chemical pot energy to electrical pot energy). This is where redox chemistry comes in, and can be referenced, if learners have done this before.
The electrons move from a high energy (high potential) on the positive terminal) to a low potential (negative terminal) through the circuit. The potential difference is set up by the chemical reactions in the battery.
Electrical energy, which is carried by the electrons, is converted in the circuit components to other forms of energy, e.g. to light in a light bulb, or heat/radiation in a resistor. Potential energy is converted to kinetic energy as the electrons move in the conductor.

Page 16 of 17

c. What specific strategies would you employ to bridge these gaps?

Write your response here

Reteach the section!!

I think here one will have to start from the beginning because the learner has fundamental issues.

I guess I would start with What a circuit is? Talk about the components first, and let the learners play on some circuit boards to see what happens if different components are added and removed. Maybe just work with the effect of more cells in a circuit at first. I would also open up a battery and show the learners what is inside. Then link this with the function of a battery, and what current it. Then link with energy and how this is carried in a circuit, and how and why electrons flow.

And then talk about potential difference, again bringing it back to the cell and what is inside. (And I wouldn't use an analogy with a person in it as I think it creates misconceptions :-).