

ASPECTS OF REMOTE CONTROL BY RADIO IN GOLD MINES

Howard Vaughan Robson

ASPECTS OF REMOTE CONTROL BY RADIO IN GOLD MINES

Howard Vaughan Robson

A Dissertation Submitted to the Faculty of
Engineering, University of the Witwatersrand,
Johannesburg, in Part Fulfilment of the
Requirements for the Degree of Master of
Science in Engineering.

Johannesburg 1982

ASPECTS OF REMOTE CONTROL BY RADIO IN GOLD MINES

ROBSON, Howard Vaughan, M.Sc. (Eng.) University of
the Witwatersrand 1982.

This dissertation studies the general considerations related to the design of on/off radio remote control systems for specific use in gold mines.

More and more mechanisation and automation is being introduced into industry, with the mining industry being no exception. Some form of remote control equipment is generally required where these changes are taking place. As a result, the Chamber of Mines Research Organisation has been investigating the design of radio remote control systems for use underground.

Factors such as the control requirements and the environment affect the specification of the system so these are discussed first. This leads on to the general system design considerations. Infra-red, ultrasonic and radio frequency communication links, being the major possible alternatives, are compared with each other. A radio link is shown to be the most suitable. A comparison of analogue and digital encoding techniques leads to the use of the analogue tone encoding. After consideration of various modulation techniques, frequency modulation was chosen.

Aspects such as temperature stability, noise immunity and ruggedness are extremely important as they affect the reliability of the system, as well as influencing fail-safe operation.

A two channel Monorail Conveyor Control System and a Multi-channel Impact Ripper Control System highlight the practical portion of the work. Both systems provided solutions which fulfil the requirements laid down, proving that radio remote control can successfully be applied underground.

---o0o---

DECLARATION

I declare that this dissertation is my own work. Most of the information contained herein was obtained while I was employed by the Chamber of Mines Research Laboratories. I was responsible for the research project investigating the design of radio remote control systems, and as such I carried out the work recorded here. I am however grateful for suggestions and assistance which I received from other employees of the laboratory, particularly the technicians who worked under me.

This work is being submitted for the degree of Master of Science (Engineering) in the University of the Witwatersrand, Johannesburg. It has not been submitted before for any degree or examination in any other University.

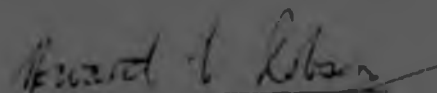

HOWARD V. ROBSON

29th day of March 1982.

---o0o---

P R E F A C E

In an effort to introduce more and more mechanisation and automation in mining, as well as increasing productivity and profitability, the Chamber of Mines Research Laboratories have been actively investigating all aspects related to this effort.

Remote control of machinery and processes was one area chosen. A number of possible applications were chosen to provide a test bed for the application of remote control, and this dissertation concentrates on the research and experimentation related to these applications.

This work does not attempt to cover every aspect in detail, but focusses on the major design areas as well as practical problem areas. The objective of the research work (to prove that remote control can be applied successfully underground) is fulfilled and the work provides the foundation for further research into the subject.

I am indebted to my colleagues at the Chamber of Mines Research Laboratories for many fruitful informal discussions on the subject. In particular I am grateful for the assistance given to me by M. Higginson, B.J.D. van der Westhuizen, R.M.E. van der Walt, J.M. Boboli, J.J. Neethling and B. Bowles.

Howard V. Robson
March 1982.

CONTENTS

	<u>Page</u>
ABSTRACT	A1
DECLARATION	B1
PREFACE	C1
 Chapter 1 - BACKGROUND TO THE PROBLEM	 1.1.
1.1. Statement of the Problem	1.1.
1.2. Review of Literature	1.4.
1.3. Review of this Dissertation	1.8.
 Chapter 2 - FACTORS AFFECTING THE SPECIFICATIONS FOR THE SYSTEM	 2.1.
2.1. Environmental Parameters	2.1.
2.2. Control Specifications	2.2.
 Chapter 3 - GENERAL SYSTEM DESIGN CONSIDERATIONS	3.1.
3.1. Definition of the Block Diagram	3.1.
3.2. Type of Communication Link	3.7.
3.3. Encoding and Decoding of Information..	3.10.
3.4. Modulation and Demodulation of the Carrier Signal	3.26.
 Chapter 4 - ASPECTS OF RELIABILITY, RUGGED- NESS AND FAIL-SAFETY	 4.1.
4.1. The Temperature Stability of the Circuitry	4.2.
4.2. Immunity of System to Spurious Signals	4.9.
4.3. A Rugged Switch Assembly	4.11.

CONTENTS

	<u>Page</u>
ABSTRACT	A1
DECLARATION	B1
PREFACE	C1
Chapter 1 - BACKGROUND TO THE PROBLEM	1.1.
1.1. Statement of the Problem	1.1.
1.2. Review of Literature	1.4.
1.3. Review of this Dissertation	1.8.
Chapter 2 - FACTORS AFFECTING THE SPECIFICATIONS FOR THE SYSTEM	2.1.
2.1. Environmental Parameters	2.1.
2.2. Control Specifications	2.2.
Chapter 3 - GENERAL SYSTEM DESIGN CONSIDERATIONS	3.1.
3.1. Definition of the Block Diagram	3.1.
3.2. Type of Communication Link	3.7.
3.3. Encoding and Decoding of Information..	3.10.
3.4. Modulation and Demodulation of the Carrier Signal	3.26.
Chapter 4 - ASPECTS OF RELIABILITY, RUGGED- NESS AND FAIL-SAFETY	4.1.
4.1. The Temperature Stability of the Circuitry	4.2.
4.2. Immunity of System to Spurious Signals	4.9.
4.3. A Rugged Switch Assembly	4.13.

	<u>Page</u>
Chapter 5 - A TWO CHANNEL MONORAIL CONTROL SYSTEM	5.1.
5.1. System Specifications	5.4.
5.2. System Design	5.4.
5.3. Description of the System	5.11.
5.4. Results Obtained in Use	5.14.
Chapter 6 - A MULTI-CHANNEL IMPACT RIPPER CONTROL SYSTEM	6.1.
6.1. System Specifications	6.4.
6.2. System Design	6.5.
6.3. Description of the System	6.8.
6.4. Results Obtained in Use	6.12.
Chapter 7 - DISCUSSION AND CONCLUSION	7.1.
7.1. Retrospective View	7.1.
7.2. Conclusion	7.4.
7.3. Suggestions for Future Work	7.5.
Chapter 8 - REFERENCES	8.1.
Appendix 1 - DESIGN ANALYSIS OF TONE ENCODER AND DECODER CIRCUITS	A1.1.
A1.1. Two Tone Sequential Encoder	A1.1.
A1.2. Two Tone Sequential Decoder	A1.2.
A1.3. Six Tone Sequential Encoding and Decoding	A1.3.
A1.4. Data Sheets for XR 367 and FX 207/ FX 307	A1.11.
Appendix 2 - DESIGN ANALYSIS OF CARRIER OSCILLATOR CIRCUIT	A2.1.
Appendix 3 - DESIGN RULES RELATED TO RELIABILITY	A3.1.
Appendix 4 - COMPARISON OF MODULATION TECHNIQUES	A4.1.

	<u>Page</u>
Appendix 5 - CIRCUIT DIAGRAMS FOR MONORAIL CONTROL SYSTEM	A5.1.
Appendix 6 - CIRCUIT DIAGRAMS FOR IMPACT RIPPER CONTROL SYSTEM	A6.1.
Appendix 7 - OTHER RELATED DATA SHEETS	A7.1.
Appendix 8 - LOOP ANTENNA DETAILS	A8.1.

---o0o---

CHAPTER 1

BACKGROUND TO THE PROBLEM

In every industry there is a constant need to strive for increased productivity and reduced costs. At the same time, increased safety and improved working conditions are very important. As a result, the mining industry, in common with other industries, is introducing more and more mechanisation and automation in order to provide solutions which fulfil the above requirements. As these changes take place, an increasing need for some form of remote control arises. Apart from these applications generated by new equipment, many existing situations could reap benefits from the application of remote signalling or control systems. There is therefore vast scope for the introduction of remote control in mining, and the success of the venture depends on a thorough understanding of the problems involved with the application of electronics underground. It is therefore necessary to conduct some research into the application of radio remote control to a number of systems in order to gain the required experience.

1.1. Statement of the Problem

The Mining Technology Laboratory of the Chamber of Mines Research Organisation is conducting research into new mechanical mining methods and mechanical systems to support the mining operation.

Rock cutters and impact rippers are two of the mining machines which are being developed to investigate mechanical methods of mining in gold mines. These machines are being tested in an experimental stope together with other mechanised systems such as monorail conveyors and shaker conveyors.

To ensure that the benefits can be obtained from the new machines, some means of effectively controlling them is required. In the cases mentioned above, all that is required is to switch a machine on or off, operate an electric motor in a forward or reverse direction or control a number of electrically operated hydraulic valves (on/off type) controlling the various movements of a machine. This might appear to be a trivial problem, but in many cases, the machine is situated remotely or in an inaccessible place. The distance between the operator and the machine can be as little as 10 m or as much as 300 m, and the machines are usually hydraulic/electric or purely electrical. Clearly the most straightforward approach would be to utilise cables, and this is the case with all the machinery mentioned. In most cases however, cable systems have proved very unreliable and unsuitable for a number of reasons.

- 1) Cables are difficult to install and maintain.
- 2) Cables often suffer damage due to movement of rock.
- 3) Lengths of cable are often stolen.
- 4) Where heavy duty cables are used to minimise chances of breakage and stealing, cabling costs are high.
- 5) Cables restrict the movement of the operator.
- 6) When the machine position must be changed, cabling has to be moved.
- 7) In the stope cables cannot be tied up as the stope is always advancing. Loose cables easily tangle around props, and are difficult to handle.

One common technique, used in place of cables, involves two operators, one at the machine and one at the remote point from which control must be effected. The remote operator then signals to the machine operator in some way (usually shouting). This is clearly not satisfactory as misunderstanding often arises, sometimes causing

damage to the machine or injury to a person.

Where the operator is fairly near the machine (e.g. 10 to 20 m) he often has to scramble back to the machine to operate it himself. This is inconvenient and time consuming and can result in damage to a machine where it cannot be switched off quickly enough when a malfunction occurs.

Clearly, the use of cables or either of the above-mentioned techniques are unsuitable, and some alternative means of controlling the remote machine is required. A "cableless" remote control system has many advantages:-

- 1) It is easy to install since there are no cables involved - only a receiver to be installed on or near the machine (the transmitter is usually portable and self-contained).
- 2) Since there are no cables there is less likelihood of failure (providing the remote control system is not unreliable).
- 3) There are no cables to restrict the movement of the operator.
- 4) Since the receiver is generally mounted on the machine and the transmitter is usually portable, it is far easier to move the machine when that becomes necessary (no cables to re-route or change).
- 5) If the system is modular and has a "plug-in" connection to the machine, no maintenance is needed underground since the system can be replaced with a spare system.

There are of course disadvantages:-

- 1) The remote control system must be extremely rugged and be able to withstand the rough environment, thus making the design of the system complicated.

- 2) Maintenance of the system requires the skills of an electronics technician (there is usually a shortage of technicians on a mine).
- 3) The "cableless" remote control system is usually more expensive than a cable system. However, when costs and frequency of repairs are taken into account, the difference in cost may not be so great.

The many advantages to be gained by the application of "cableless" remote control definitely justify the design of systems to be used on some of the machines mentioned earlier. These prototype systems will serve as a research tool to help ascertain the feasibility of applying remote control in general applications. They will also provide the opportunity to investigate ways of eliminating or minimising the disadvantages just discussed.

1.2. Review of Literature

Remote control is already being successfully applied in many other sectors of industry (other than mining). One of the areas where remote control has been applied for a number of years is in materials handling, particularly on cranes. The use of radio control systems has realized the following advantages:-

- 1) Increased productivity, since the operators can control the crane from the floor and can therefore perform other tasks such as hooking and unhooking the load. Previously two other personnel were required - the "hooker" and the "signalman".
- 2) Downtime is reduced since the operator can position himself so as to clearly see the operation thus avoiding confusion and accidents which could occur without radio control.

- 3) Greater safety is provided since the operator is mobile and can choose the best vantage point¹.
- 4) There is a definite increase in reliability since there is "no physical connection between the control console and the equipment being controlled"⁴. When cables are used there is a greater chance of a failure due to damage of the cable.

Besides applications in materials handling, radio remote control has been used in many other applications, usually with similar advantages to those mentioned above. Radio remote control was introduced to control locomotives handling crude ore and waste rock in an iron ore pit mine⁵.

Radio remote control is often used where the equipment to be controlled is remote and inaccessible. An example was the remote switching of an inaccessible substation in the mountains⁶.

Radio remote control has also been used to carry out secondary network switching⁷, capacitor switching⁸ (for power factor correction) and load management⁹ in electricity distribution systems.

Another interesting application area is that of remotely manned systems. Remotely controlled fire-fighting robots, remotely guided missiles and remotely controlled manipulators used in radio-active environments are but a few of the potential applications¹⁰. Remote control could be used for buses in metropolitan areas, interplant transportation and in industrial areas. A typical industrial application would be in mines and quarries. The major advantages of non-driver controlled vehicles lie not only in automation, but also in increased length of service and greater operational reliability.¹¹

Radio remote control has also been used in many mining applications. The most common application is in the control of continuous miners used for coal mining. Here remote control provides definite advantages.

- 1) Safety is increased since the operator can remain under a supported roof whilst advancing the continuous miner into the unsupported area. The operator is also subject to less danger because he is located away from the machine¹².
- 2) Better visibility of the whole operation can be obtained since the operator can view the whole face¹³.
- 3) Bad roof conditions often force abandonment of mining in an area before all the coal has been extracted. Remote control allows mining to continue¹⁴.
- 4) Productivity is increased by 10 - 15% because of higher utilisation of the continuous miner¹⁴.

Cable hauled monorails have also been controlled by remote control^{15,16} in French and Belgian coal mines. These systems bring about increased safety, manpower savings, improved transport and greater flexibility of use.

Rock shearers and loader trucks¹⁵ have also been controlled remotely. In both these cases, the main reason for using remote control was to improve safety. The shearers are operated in a dangerous environment whilst loader trucks must also be taken into dangerous areas sometimes (when entering a dangerous area the driver gets out and then controls the truck remotely).

Mine locomotives have also been controlled by radio remotely¹⁷. Another application with regard to trains involves signalling along the train, or from train to train to co-ordinate movements. Work has been done on the radio propagation aspects of the problem.¹⁸

Judging from the literature the most popular encoding technique is tone encoding, normally with a sequence of tones, 19,20,21,22,9,7,1. In most cases, the sequence consists of a minimum of 3 tones. Some of the systems utilise 3 tones to select a channel with one or two extra tones which must be present as well (common to a system) thus giving the capability for a number of systems.

Digital techniques are also used for encoding. Pulse Code Modulation is the most popular technique^{1,23}. With this technique, security of transmission is often enhanced by the use of a parity bit and duplicate transmissions. Pulse Position Modulation is also used, particularly in hobbyist circles. It has however also been used underground¹⁵. Pulse Width Modulation could also be used, however it does not seem popular.

Where Pulse Code Modulation is used, some means of representing the data in a serial bit stream must be used. Two techniques enjoying popularity are the following:-

- 1) Manchester Phase Encoding - specialised integrated circuits are available which use this technique (e.g. Supertex Inc. ED5, ED 9, ED 11 and ED 15).
- 2) Pulse Width Encoding - here the width of the pulse differentiates between a "1" and a "0". A specialised encoder/decoder from National Semiconductor (MM 53 200) utilises this technique.

The almost universally used modulation technique (in the references given so far) is Frequency Modulation (F.M.) The biggest advantage of this technique is its noise immunity. Carrier frequencies vary from medium frequencies (MF) right up to ultra high frequencies (UHF). There seems to be no particular preference except for the fact that MF transmissions couple particularly well into cables and pipes, and are also not significantly affected by the dimensions of the areas underground.

It is frequently stated (once again within the references cited so far) that reliability, noise immunity and ruggedness are all extremely important factors. Also not to be neglected are effects such as intermodulation and cross-modulation.

Thus it can be seen that the applications of radio remote control in mining are many and varied. In all cases, a number of benefits accrue from the use of radio remote control. Many decisions have to be made regarding the design of remote control systems and these have to be made in the light of the requirements of the application, as well as the conditions under which the system will operate. In order to design successful systems, a certain amount of experience is required with the application of remote control underground.

1.3. Review of this Dissertation

In order to gain the required experience a number of practical applications, which required remote control, were chosen. A modular remote control system has been developed which has been applied in a number of different situations. The considerations involved in the design of the system, together with aspects of reliability, ruggedness and fail-safe operation, are given detailed coverage. A discussion of two case studies shows the

practical application of the systems designed. A discussion highlights specific points of interest and in conclusion, suggestions are made as to how future systems should be designed, in the light of the practical experience gained.

---000---

CHAPTER 2

FACTORS AFFECTING THE SPECIFICATIONS FOR THE SYSTEM

Before a remote control system can be designed, the system specifications must be clearly laid down and understood. Various factors play a part in influencing the specifications for the system, and these factors must be considered:-

2.1. Environmental Parameters

When not clearly understood the environment could prove the biggest stumbling block to the successful application of electronics of any form underground.

One very stringent requirement to be met is that the equipment should operate continuously in an environment where the relative humidity can be as high as 100% or where there can even be direct water spray onto surfaces where equipment is mounted. Clearly in these areas equipment enclosures should be sealed, and preferably waterproof. The fact that makes this sealing more difficult is that equipment is closed on surface and then taken underground where the pressure is higher, thus causing a differential pressure which causes leakage into the box. Corrosion is another big problem since the water, and even the humid air is highly corrosive.

The ambient temperature is also elevated and is usually in the range of 30°C to 35°C, however in certain poorly ventilated areas it can probably rise to around 40°C.

This fact, coupled with the necessity to seal the equipment enclosure, means that power dissipation in equipment must be kept to a minimum. It can thus be said that the components themselves should operate in the temperature range of 25°C to 70°C (upper limit is that of most commercial grade components) with 50°C being a more practical and likely upper limit. Circuitry must be designed and set up bearing this in mind.

Where equipment is to be mounted on a machine, it should clearly withstand vibration. In such cases the vibration level on the machine will have to be measured, and the equipment tested under similar conditions in order to ensure its suitability.

Transients and noise are often present on the electrical supply. This is due to the fact that much heavy equipment is operated off the same electrical supply. There are also sources of radio frequency interference, such as other radio systems operating in the medium frequency range, and other sources such as thyristor controllers and neon lights. The system should not only be immune to these noise sources but should be able to operate in an environment where they are present.

Finally, the equipment should withstand very rough handling and should be immune to dust and grit, particularly quartzite dust which is highly abrasive.

2.2. Control Specifications

These specifications relate to the operating requirements of a remote control system, and the general details are discussed here. Specific areas are expanded on in later chapters.

Any battery operated equipment must operate for a full shift of eight hours. A suitable battery voltage must be chosen. This is a difficult decision in that on the one hand the voltage must be kept as low as possible to keep the battery pack small. On the other hand, some integrated circuits do not function correctly below a certain voltage. The XR 2206 is a case in point - its operation is only specified for a supply voltage $10 < V_{cc} < 26$ (see appendix 2 for data). 12 V is therefore a good compromise as it is also a very popular battery voltage, with standard battery packs always being available with a 12V supply voltage.

The remote control system should be fail safe, and there should be no possibility of injury to personnel or damage to machinery.

As a result of the difficulty of repairing equipment, together with the fact that mining production must be maintained, equipment should be designed to be extremely reliable. The design should also be modular with both the boards and the system itself being of a plug in type. This facilitates easy repair and replacement.

The electronic circuitry should be stable and should not require re-adjustment over long periods of service.

In general, the system should operate over a range of up to 300 m (approximate maximum), and the receiver should have a wide dynamic range since in some cases the transmitter and receiver are within 2m of each other.

Electrical cables and pipes are present in many areas so if medium frequency radio propagation is chosen (see chapter 3) they may assist the propagation of the signal. This is due to coupling of the signal into the cables and pipes.²⁴

Two different requirements arise as far as the number of channels which are required. Where machines must be switched on or off, or a motor operated in a forward or reverse direction, two channels are required. The other requirement is for a multi-channel system. This would control a machine such as an Impact Ripper, which requires 13 on or off channels. It is not possible to set an upper limit on the number of channels which may be required in future machines, however machine designers feel that it probably wouldn't be more than 20. There are also machines, such as an experimental rock loader, which require proportional control of some functions whilst the other functions would only require an on or off channel (this is mentioned here for completeness however when the systems discussed in chapters 5 and 6 were designed, this requirement did not exist).

Although the requirement is for a maximum of 20 channels, it is practical to assume that only three channels would be required to operate simultaneously. The operation of the machine is such that it is only logical to operate one or two movement functions simultaneously. To provide for fail-safe operation one channel may be required to operate continuously. This channel might either maintain the machine in a running condition (see chapter 6) or enable control of the other channels only when it is operated.

Finally the response time must be specified. For two channel systems a fairly arbitrary limit of 500 ms can be set on the response time. If the response time was longer (e.g. 1 sec) the operator would possibly be disturbed by the delay in response. Other than this, there is no reason why the response time need be < 500 ms since a machine is only being switched on or off or a motor operated in a forward or reverse direction. In the case of the multi-channel Impact Ripper system the

2,5

response time requirement could not be decided without tests on the machine. A response time of 300 ms was found to be adequate (see Chapter 6).

This has not been an exhaustive general study of all the aspects affecting the specifications for a radio remote control system to be used underground. It has concentrated on aspects related to the systems discussed in Chapters 5 and 6 and has also very briefly covered aspects which are considered in more detail in the following chapters.

CHAPTER 3

GENERAL SYSTEM DESIGN CONSIDERATIONS

In designing a system which must provide solutions to a number of different but related problems, it is absolutely essential to adopt a top down approach to the design of the system. In this way, the design goals are kept clearly in mind whilst working at the block diagram level, thus ensuring that boundaries between different blocks are defined in such a way that optimum modularity is achieved.

3.1. Definition of the Block Diagram

A remote control system is any system where the control inputs and actuating outputs are separated (i.e. remote). Figure 3.1. clarifies the concept.

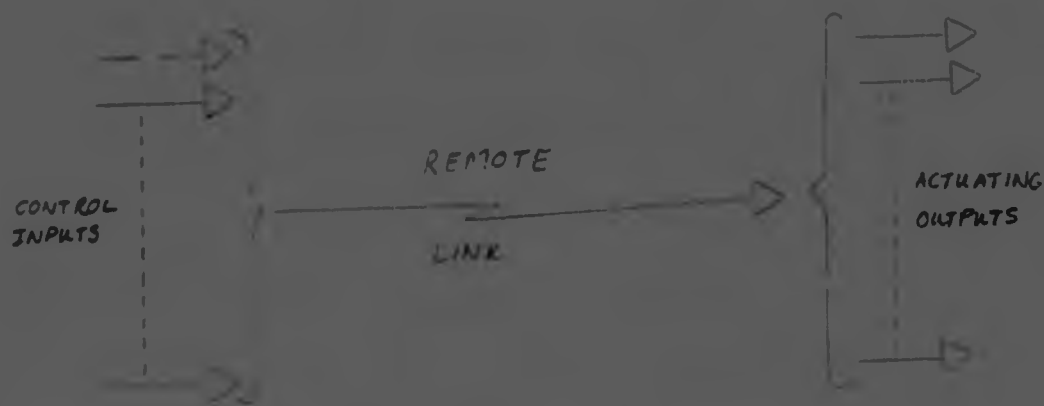

Remote Control - The Concept

Figure 3.1.

In the simplest of cases, a multi-core cable might provide the "remote link" for a remote control system. Building on this concept, some form of encoding and decoding could be provided which would then reduce the "remote link" to a pair of wires. Such a system will be referred to as a "type 1" system, and it is shown in figure 3.2.

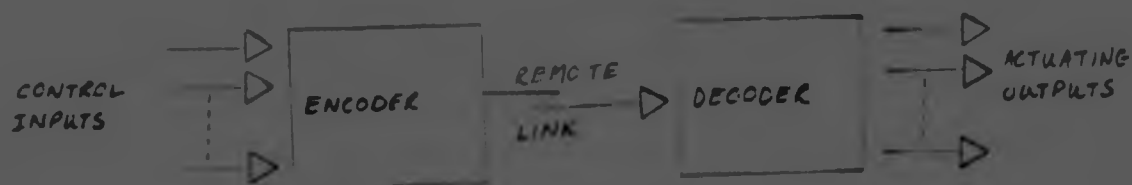

Remote Control - Type 1

Figure 3.2.

In order to eliminate the pair of wires, the encoded signal must be modulated on a carrier signal of some form or other, thus providing a "type 2" system as shown in figure 3.3.

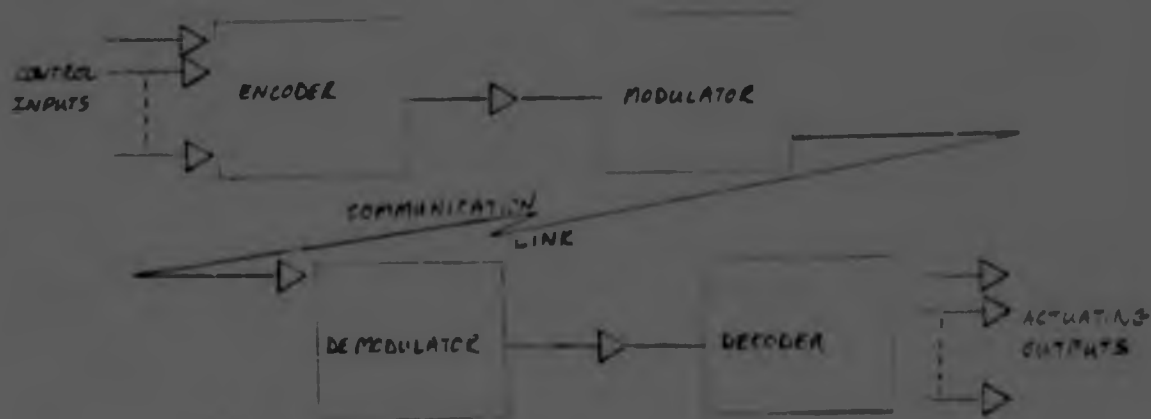

Remote Control - Type 2

Figure 3.3.

The link is now referred to as a communication link since there is no physical connection.

Another factor which is inevitably part of any control system is feedback. In many remote control systems where a human operator is involved, the only feedback path is provided by the human. In the simplest form the human senses (sight, hearing and touch) provide the feedback. In this case the system would not change from those previously discussed. However, in a number of cases it may be desirable to convey information back to the point from which control is being carried out. This may be necessary if the distance or conditions prohibit "human feedback" or the parameters to be monitored cannot be observed. In type 1 remote control, this would mean one of two things:-

- 1) The feedback is provided by a totally independent similar system operating in the reverse direction.
- 2) The same link would be used in both directions thus necessitating synchronization between ends.

These two cases are shown in figure 3.4.

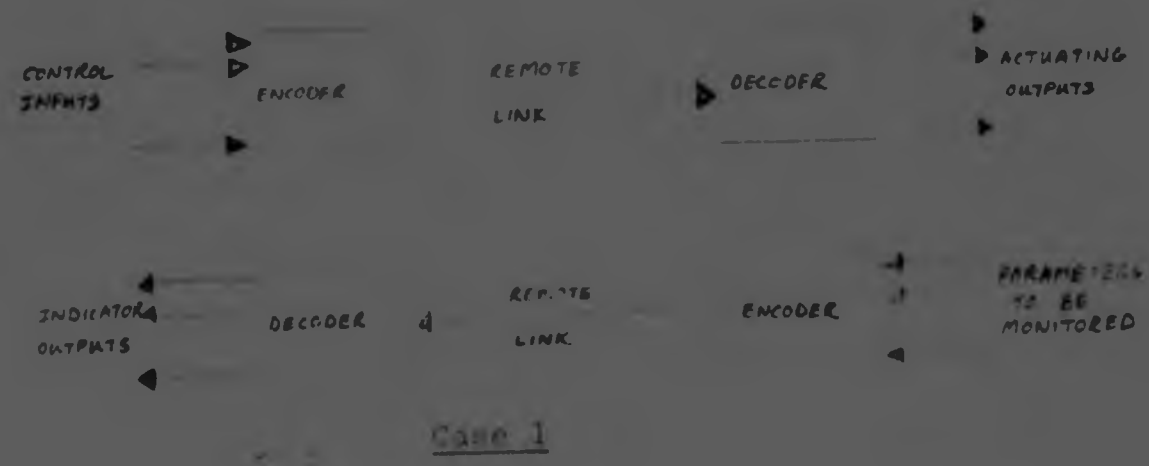

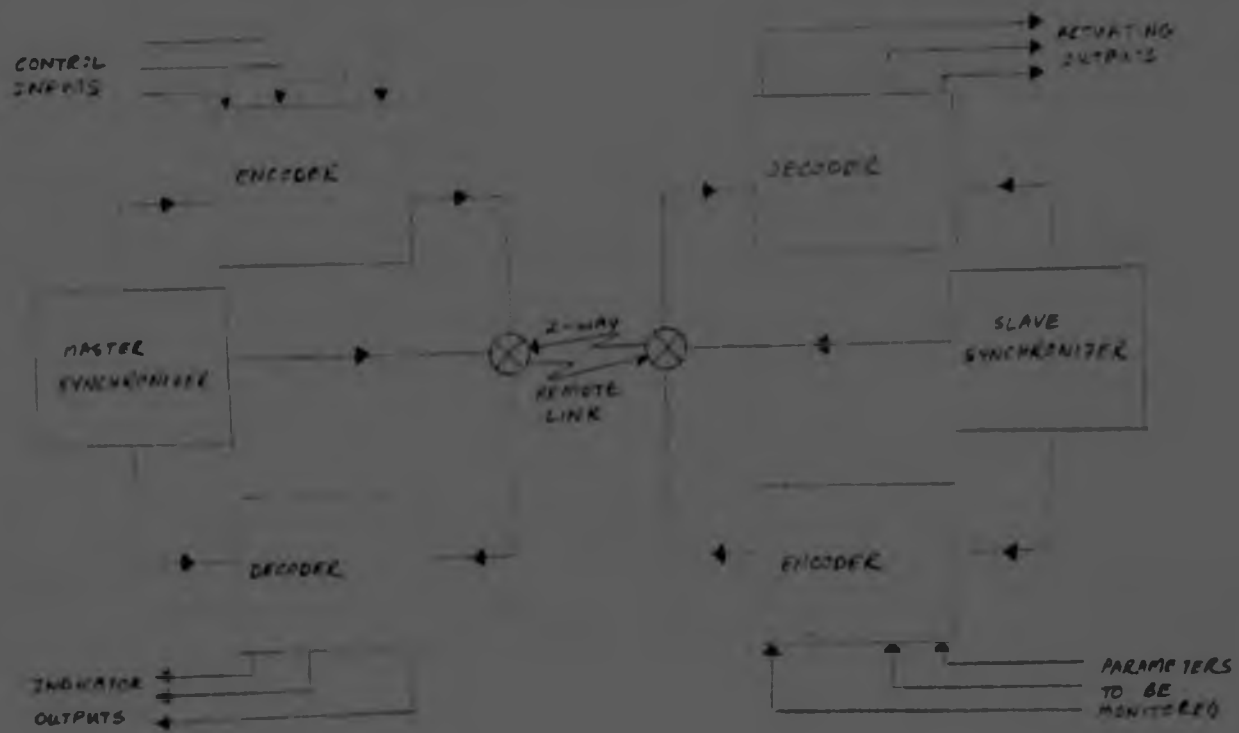

Case 2

Remote Control - Type 3

Figure 3.4.

Where feedback is required in a type 2 system we would also have the same two alternatives as before, as shown in figure 3.5.

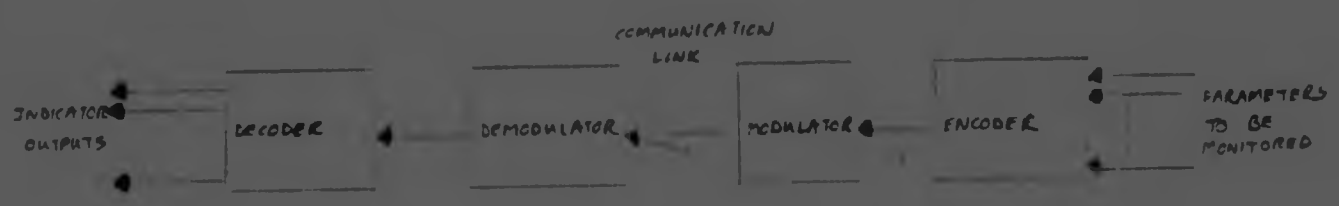
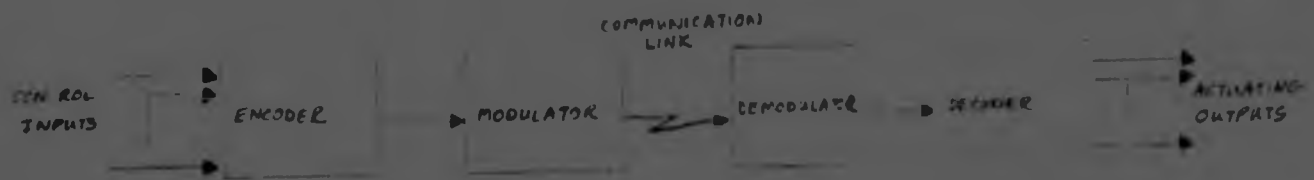

Case 1



Case 2

Remote Control - Type 4

Figure 3.5.

16

In both type 3 and type 4 systems the actual "closing of the loop" has not been shown however this would be done either by a human or by the system itself.

The rather painstaking way in which we have developed the various types of systems has served one important purpose - it has helped to show how the system should be sub-divided into modules to ensure maximum flexibility independent of the type of system required.

It is thus clear from the preceding discussion that the design of remote control systems revolves around three main areas.

1) Encoding and Decoding of Information

An encoding technique must be chosen to provide the necessary security, noise immunity and compatibility with the desired response time and number of channels. The corresponding decoding technique must operate within the expected signal to noise ratios, provide the required security and "fail-safety" and operate within the desired response time.

2) Modulation and Demodulation of the Carrier Signal

The type of modulation must be chosen to provide the required performance in the presence of noise, operation within the desired bandwidth and compatibility with the encoding and decoding techniques. The demodulation of the signal should fulfil the same requirements.

3) Type of Communication Link

A suitable communication method must be chosen which will operate within the environment underground, as well as over the range required. The appropriate carrier frequency will also have to be chosen.

The type of communication link will be considered first, since the decision here may influence the considerations in the other two areas.

3.2. Type of Communication Link

Since cables are not desirable the control must be carried out via either radio waves, ultrasonic waves or infra-red waves.

Ultrasound^{25,26} is a fairly attractive technique where control is required over a range of up to 20 m. Beyond this range, higher power transducers are needed.

Also, in many mining situations where remote control is used, line of sight is restricted to approximately 20 m (particularly in the stope). A number of benefits can accrue from its use.

- 1) Cheap low power ultrasonic transducers are readily available.
- 2) Large scale integrated circuits are available which directly drive these transducers, and are designed for multi-channel remote control applications.
- 3) The use of ultrasound does not use up any portion of the electromagnetic spectrum. This usable portion of the electromagnetic spectrum is at a premium, especially in the medium frequency region where optimum propagation through rock can be obtained.
- 4) No licenses are needed to operate ultrasonic equipment.

There are of course disadvantages:-

- 1) Ultrasonic interference could be caused by various pieces of machinery operating underground. Particularly impulsive noises could be troublesome.

- 2) Over ranges of more than 20 m, higher power transducers would have to be used and the effects on personnel are not entirely known.
- 3) Over longer ranges, propagation would become directional and reflections off walls could not be relied on.

Detailed information about all the above disadvantages is not available and an extensive series of measurements would have to be carried out to prove or disprove the abovementioned disadvantages.

Infra-red ²⁷ light waves are attractive for the same reasons as ultrasound. The main disadvantages are listed below.

- 1) Infra-red energy is radiated by all bodies whose temperature is above absolute zero. Since virgin rock temperatures are high in deep gold mines (around 50°C to 60°C) a fair amount of infra-red radiation could occur and tests would have to be carried out to ascertain the levels of radiation, and hence the expected propagation range.
- 2) Over longer ranges than 20 m, one could not rely on direct line of sight and it is not known how much reflection of light off the rough, dark surfaces in a mine could be relied on. Tests would have to be done to ascertain this.
- 3) Infra-red detectors which are resonant have not been constructed and hence the detector responds to all infra-red frequencies, thus making it difficult to have different systems working on different infra-red frequencies.
- 4) Water vapour and carbon dioxide are strongly absorbing to infra-red and since the humidity is close to 100% in many situations underground, this could pose a serious problem.

At the Chamber of Mines Research Laboratories extensive research has been carried out in the field of underground voice communication systems. This then makes the choice of a radio communication link a good decision. There are in addition other advantages offered by a radio link:-

- 1) Propagation can be achieved over ranges exceeding 1 km underground²⁴.
- 2) Integrated circuits are available which ease the whole design from the radio frequency stages through to the encoding and decoding circuitry.
- 3) Where propagation through rock²⁴, or over long ranges, is not needed, medium frequencies (100 kHz to 1 MHz) need not be used, thus conserving this part of the electromagnetic spectrum for systems requiring "through rock propagation."
- 4) More is known about the performance of radio receivers in the presence of the noise found underground.
- 5) Radio design research work has been done by the Chamber of Mines Research Laboratories, and some of this work is adaptable to the requirements of remote control systems.
- 6) Where medium frequencies are used, there is very little directionality and no dependance on the surfaces of walls and hangings. Since the wavelengths are in excess of 300 m which is orders of magnitude larger than the dimensions of the areas underground.
- 7) Medium frequencies couple well into cables thus extending the range of propagation considerably over that where not cables are present²⁴.

There are also disadvantages to the use of a radio link:-

- 1) Part of the electromagnetic spectrum is occupied, and this usage must be carefully controlled at medium frequencies where voice communication systems are already in use.
- 2) The choice of antenna can pose a problem, particularly at medium frequencies where small antennas are very inefficient.

The final deciding factor in choosing a radio communication link for initial remote control systems was the need to provide the first system within a year. A choice of infra-red or ultrasonic would have required an unknown amount of initial research work as these techniques had not been used by the Chamber of Mines Research Laboratories. References to the use of infra-red or ultrasonic in similar situations were not available. Also, since a modular design approach is to be adopted, a change to a different "link" (infra-red, ultrasonic or cable) at a later stage would involve a minimum of extra design work.

3.3. Encoding and Decoding of Information

As mentioned earlier there are a number of important points to be borne in mind when choosing encoding and decoding techniques. The techniques used should provide the necessary security and noise immunity. They should also provide operation within the desired response time, as well as providing for the maximum number of channels. Another desirable, but not essential, requirement is that a number of different and independent systems should be able to operate on the same carrier frequency. This would be particularly important in the future where a large number of independent remote control systems

might operate in a particular area, and where it might not be suitable to use different carrier frequencies (since, as mentioned earlier, there is a need to use the medium frequencies sparingly).

Certain overall design limits can be laid down in terms of the system specifications given in Chapter 2.

Battery operation of a hand-held transmitter for an eight-hour shift will definitely pose restrictions on the design of the system, so this aspect must be analysed now. For a hand-held set, the largest capacity batteries that can be used have a 500 mA Hr capacity (pen-light size - Nickel Cadmium type).

Thus, the total amount of power available is:-

$$P_T = \frac{\text{Battery Capacity}}{\text{Length of Shift}} \times \frac{\text{Supply Voltage}}{1}$$

$$= \frac{500 \times 10^{-3}}{8} \times \frac{12}{1} = \underline{0,750 \text{ W}}$$

Assuming that all circuitry apart from the power output stage consumes 10 mA continuously (if this is not achievable in practice these calculations will have to be repeated). The power thus dissipated is:-

$$P_D = V \times I$$

$$= 12 \times 10 \times 10^{-3} = \underline{0,120 \text{ W}}$$

Therefore, the power available for the power output stage is:-

$$P_A = P_T - P_D$$

$$= 0,750 - 0,120 = \underline{0,630 \text{ W}}$$

Assuming 50% efficiency in the power output stage, the actual output power (transmitted) would be:-

$$P_o = \frac{P_A}{\eta} = \frac{0,315 \text{ W}}{0,5}$$

Practically, an output power (transmitted) of 1 W is found to be necessary where the range required could be as great as 100 m and where no coupling into any existing cables and pipes can be relied on. Although this is not a significant increase in power, it is as well to design a system which is capable of transmitted powers in excess of the continuous power which is available. To achieve this goal, the need for continuous transmission must be avoided. By introducing an "on" and an "off" period in the transmission, the available output power can be increased as the duty cycle is reduced. The duty cycle is determined as follows:-

$$\begin{aligned} \text{Duty Cycle} &= \frac{P_o}{P_T} \\ &= \frac{0,315}{1} = 0,315 \end{aligned}$$

where P_o = available output power

P_T = required output power.

As an overall response time of 500 ms is required (see for the two channel system discussed in chapter 5) the transmission time is determined from the duty cycle.

$$\begin{aligned} T_T &= (\text{Duty Cycle}) \times T_B \\ &= 0,315 \times (500 \times 10^{-3}) \\ &= \underline{158 \text{ ms}} \end{aligned}$$

where T_B = response time

T_T = transmission time

Thus we have the situation, shown in Figure 3.6.

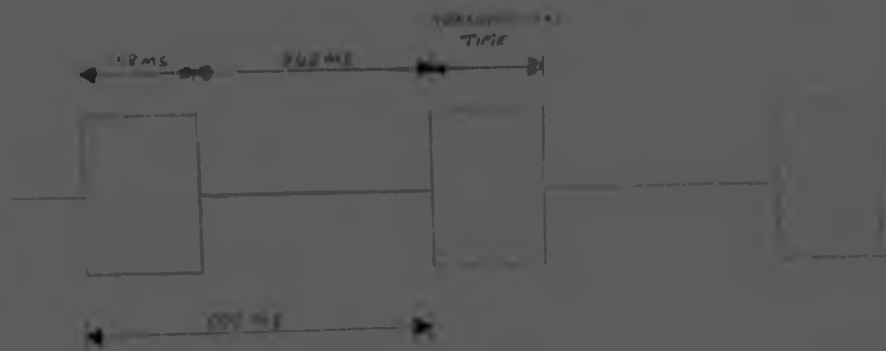

Transmission Time and Period for Two Channel System

Figure 3.6.

The same duty cycle applies, whatever the response time requirement. Thus for a response time of 300 ms (as for the multi-channel system discussed in chapter 4):-

$$\begin{aligned} T_m &= 0,315 \times (300 \times 10^{-3}) \\ &= \underline{95 \text{ m S}} \end{aligned}$$

It is therefore clear that any encoding/decoding of control information must be done in 159 ms for the two channel system and in 95 ms for the multichannel system.

The ability of the encoding/decoding technique to reject noise or operate with a poor signal-to-noise ratio (SNR) is an important factor to be borne in mind, when choosing the technique. A technique which operates with either a zero or negative SNR is desirable if possible.

Lastly, the encoding/decoding technique should be stable enough so as to require no re-adjustment after commissioning of the system.

With these factors in mind, the two major techniques for encoding/decoding of information can be considered and their relative merits discussed.

3.3.1. Analogue Techniques

The most common analogue technique involves the use of tone encoding with a combination of tones or a sequence of tones. To encode with a combination of tones is clearly simpler since all that is required is a number of tone oscillators and a mixer, however, the information about which channel (or function) is to be operated is only carried via the actual frequencies of the tones. By judicious choice of the combinations of tones (e.g. non-harmonically related), the likelihood of spurious operation can be kept very low. Although sequential tone encoding is slightly more complex, since the tones must be sequenced, additional information is carried by the actual sequence of tones (over and above that of the frequencies of the tones). The likelihood of spurious operation is also reduced from that of combinational tone encoding, due to the fact that a spurious signal would have to provide the correct tone frequencies as well as the correct sequence. It is therefore clear that sequential tone encoding is the better of the two techniques.

In this context, a spurious signal is any signal other than that produced by the system. Spurious signals can be split into two categories:-

- 1) Signals from other similar systems operating in the same area.
- 2) Noise or interference signals.

To counter the first category of spurious signals (when using analogue techniques) the important problem areas are intermodulation products and harmonics which can be generated from the tones used.

Noise and interference signals are more difficult to quantify, however most potential noise sources are well known and cognisance can therefore be taken of their possible effect.

Both these problem areas will be considered and borne in mind when the encoding/decoding techniques are chosen, and also in chapter 4 where the importance of safe reliable operation is covered in more detail.

The practical aspects of how such a system would be implemented are also important since they can effect its feasibility. Firstly, single transistor oscillators (TWIN-T feedback network) can be built where the frequency can be changed over an octave range by only varying one resistor. This means that resistors can be switched to change the tone frequency of a single transistor oscillator. These oscillators also produce a reasonably high purity sinewave, which means that generation of harmonics is kept to a minimum. A TWIN-T oscillator is shown in figure 3.7.

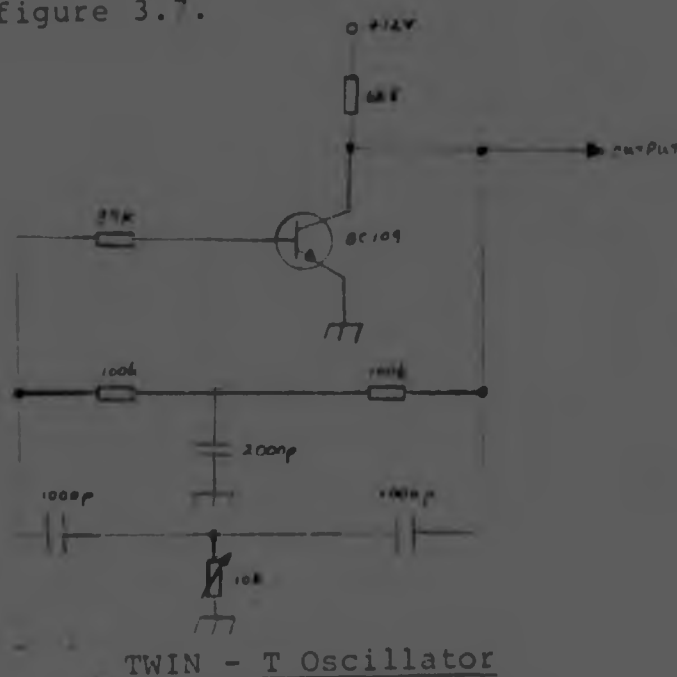
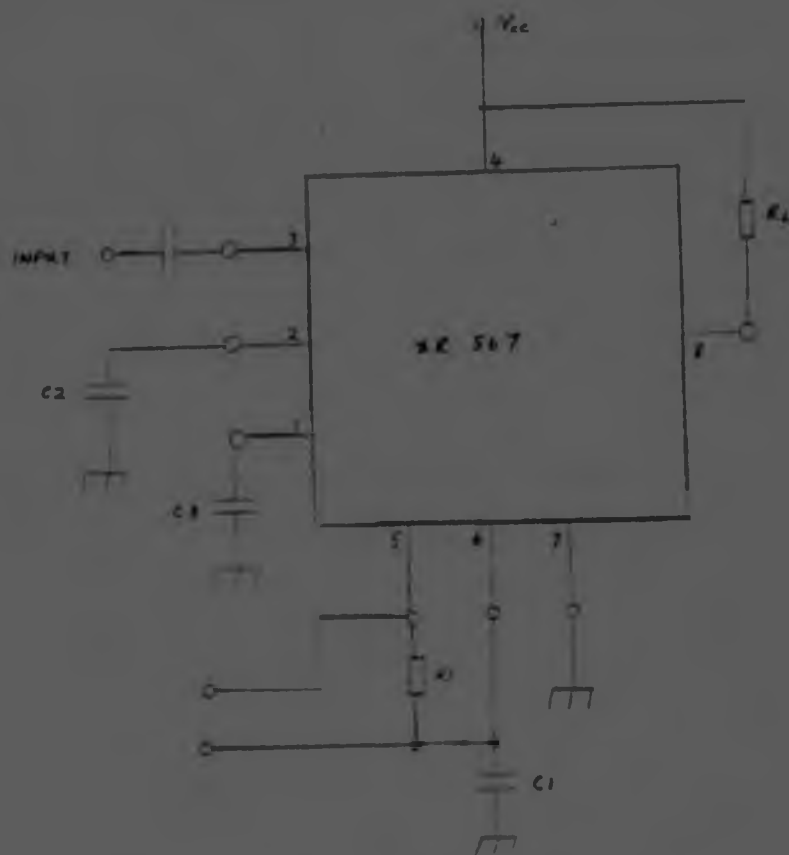

Figure 3.7.

On the decoding side, an integrated circuit phase-locked loop tone decoder (567 - see appendix 1 for data) is available which provides high stability and noise immunity. It can even operate with a negative signal to noise ratio (-6dB Typical for wideband noise). Figure 3.8. shows a typical circuit of a tone decoder using the 567. The simplicity of the circuit is evident.



567 Tone Decoder Circuit

Figure 3.8.

A sequence of two tones is probably adequate for simple systems where only one or two channels are needed per controller. Another advantage of tone encoding is the fact that no synchronisation is needed between the transmitter and the receiver. This is important since it means that there is no difficulty with operation of more than one system on the same carrier frequency - different transmitters on the same carrier frequency can transmit different tone sequences asynchronously and all receivers will

receive the tones, however each decoder will still decode its own tone sequence. Also, in multi-channel systems the channels can be time-division multiplexed, but there is no need for synchronisation since each tone sequence is unique and the information about the channel is carried only by the tones and their sequence - thus the order of the channels is unimportant. From the data sheet in Appendix 1 it can be seen that a 567 tone decoder requires a maximum of 100 cycles of the tone frequency (f_0) to operate (when the bandwidth is 5% of f_0). If we limit ourselves to tones in the audio range up to 4 kHz we see that worst case response time occurs with low frequencies. We can thus determine a lower limit by using the transmission time determined earlier. For a two channel system (with 500 ms response time) this is 158 ms.

$$f_{\text{low}} = \frac{\text{No. of sequential tones} \times \text{no. of cycles/tone}}{\text{transmission time}}$$

$$= \frac{2 \times 100}{158 \times 10^{-3}}$$

$$= \underline{1,265 \text{ kHz}}$$

Thus, for a sequence of two tones we see that frequencies in the range of 1,265 kHz to 4 kHz can be used. Where faster response times are required, or there is a need to operate a number of channels simultaneously, two approaches can be adopted:-

- 1) Use higher tone frequencies to speed up response time.
- 2) Use wider bandwidths for tone decoders and hence speed up response of tone decoders.

The former requires a wider radio frequency bandwidth and the latter leads to fewer distinct tone frequencies and lower noise immunity. Thus it would appear that in multi-channel applications with a requirement for more than three or four channels, the use of these tone decoders is not appropriate.

Other techniques (besides phase locked loops) are available for decoding of tones. One which offers faster response times, works on a period sampling technique averaged over a number of samples. The period sampling technique yields very sharp channel definition, coupled with exceptionally high rejection of outband noise. It does however mean that although it is almost impossible for adjacent channel signals, harmonics and noise to cause a false output response, the mixing of two or more frequencies can inhibit decoding of the tones. For this reason simultaneous transmission of different code groups over a common communication channel (i.e. operation of more than one system on the same radio frequency) should be avoided. This could be a problem where there is congestion of the electromagnetic spectrum due to many systems being in use. In areas where electrical and electromagnetic noise is prevalent the inability of the zero-crossing detection circuitry to discriminate between the signal and noise may result in inconsistent operation as it will not be able to decode the transmitted tone sequences. However, whilst these limitations may appear significant, they can be overcome by careful design.

An integrated circuit (Consumer Microcircuits FX 207) is available which provides tone generation and encoding for eight different sequences of three tones whilst a companion circuit (FX 307) performs the compatible decoding of these eight channels. These circuits offer high stability and are simple to set up and use, whilst

responding far more rapidly (in a minimum of ten cycles) than phase-locked loop tone decoders. It is thus clear that this technique would have application in multi-channel systems where faster response is desirable. The simplicity of an 8 channel encoder/decoder is shown in figure 3.9.

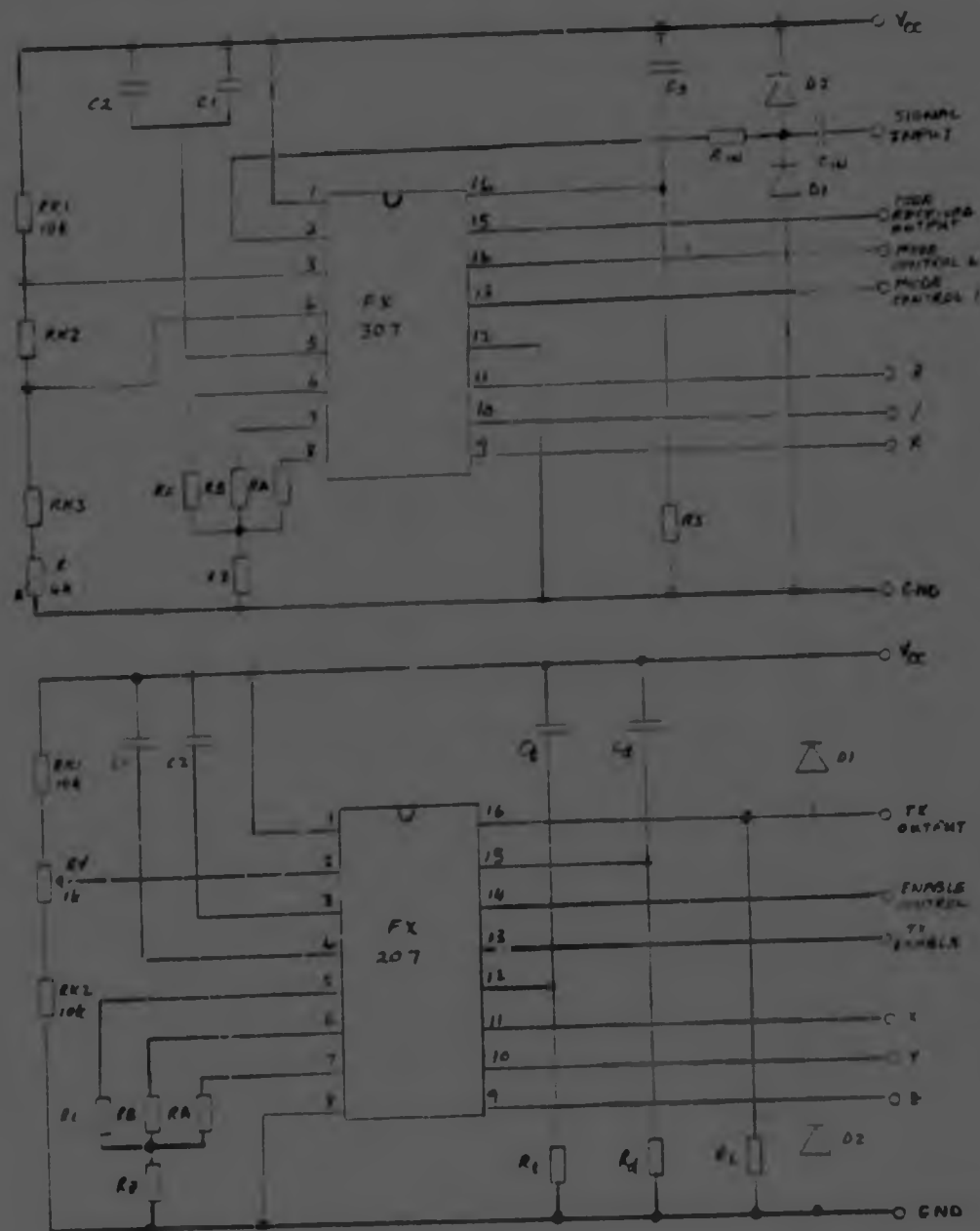

- A. FX 207 - 8 Channel Encoder
- B. FX 307 - 8 Channel Decoder

Figure 3.9.

As mentioned in Chapter 2, a maximum of twenty channels is realistic. One means of obtaining twenty channels with these circuits is to sequence the outputs of two of the encoders to provide a sequence of six tones. This thus provides for sixty four different channels. Bearing in mind the 300 mS response time given earlier and the related transmission time of 95 mS we can once again set a lower limit on the tone frequencies which can be used. To provide the required mark to space ratio we thus require three channels to be decoded in 95 mS (i.e. 31.67 mS per channel). The lowest usable tone frequency would thus be (assuming six tones and ten cycles per tone).

$$\begin{aligned}
 f_{low} &= \frac{1}{T_{low}} = \frac{N}{N T_{low}} \\
 &= \frac{6 \times 10 \text{ cycles}}{31.67 \text{ mS}} \\
 &= \underline{1.894 \text{ kHz}}
 \end{aligned}$$

where T_{low} = period for frequency f_{low}
 N = no. of cycles.

In practice the frequency will be higher than this, due to the fact that the tones cannot follow on directly from each other and also due to the fact that more than 10 cycles of each tone are needed to ensure decoding in noisy conditions. However, it is still practical since these encoders and decoders can operate up to a maximum frequency of 7 kHz.

Detailed design analysis and testing of the two analogue techniques is given in Chapter 4 and Appendix 1.

As mentioned in Chapter 2, a maximum of twenty channels is realistic. One means of obtaining twenty channels with these circuits is to sequence the outputs of two of the encoders to provide a sequence of six tones. This thus provides for sixty four different channels. Bearing in mind the 300 mS response time given earlier and the related transmission time of 95 mS we can once again set a lower limit on the tone frequencies which can be used. To provide the required mark to space ratio we thus require three channels to be decoded in 95 mS (i.e. 31,67 mS per channel). The lowest usable tone frequency would thus be (assuming six tones and ten cycles per tone).

$$\begin{aligned}
 f_{low} &= \frac{1}{T_{low}} = \frac{N}{N T_{low}} \\
 &= \frac{6 \times 10 \text{ cycles}}{31,67 \text{ mS}} \\
 &= \underline{1,894 \text{ kHz}}
 \end{aligned}$$

where T_{low} = period for frequency f_{low}
 N = no. of cycles.

In practice the frequency will be higher than this, due to the fact that the tones cannot follow on directly from each other and also due to the fact that more than 10 cycles of each tone are needed to ensure decoding in noisy conditions. However, it is still practical since these encoders and decoders can operate up to a maximum frequency of 7 kHz.

Detailed design analysis and testing of the two analogue techniques is given in Chapter 4 and Appendix 1.

3.3.2. Digital Techniques

The advantages and disadvantages of digital techniques (as opposed to analogue techniques, must be considered before an encoding/decoding technique is chosen. All digital encoding/decoding techniques require some form of synchronisation between the encoder and the decoder since the bits of data relating to different channels are time multiplexed and transmitted serially. Depending on the design of the system, a loss of synchronisation may result in a number of problems:-

- 1) Incorrect decoding of information..
- 2) Loss of information until the system resynchronises.

Clearly, incorrect decoding of information must be avoided and the system must therefore be designed to reject information until the system is in synchronisation. Frames (i.e. information blocks between synchronisation periods) must therefore be kept short and synchronisation must be reliable. To avoid loss of continuity on channels, information from a number of successive frames must be combined such that control is only lost if more than this successive number of frames are out of synchronism. It is technically difficult to have more than one system on the same carrier frequency since mixing of the data from different systems will scramble the data and render it useless. One method of overcoming this problem is by synchronisation of the different systems such that only one system transmits at any one time, however this is difficult and introduces extra complications into the circuitry. As mentioned already, noise immunity and security can be improved by combining a number of successive frames and only executing control if the same information is received a number of times in succession.

This of course increases the response time. The other alternative is to use error detection and correction codes, or redundant codes. This technique increases the complexity of the system. A clear advantage of digital techniques is their flexibility and easy expandability to more complex systems or to include proportional control. Another advantage is their inherent stability and simplicity of the setting up procedure.

Where the system only requires on/off control of two channels, one at a time, a 2 bit code could be used where the following conditions would apply.

00 = both channels off
01 = channel 1 on
10 = channel 2 on
11 = invalid (or channel 1 and channel 2 both on where this condition is allowable).

For as long as a particular control was required, the transmitter would therefore transmit that code repetitively with the mark to space ratio discussed earlier. The simplest way of increasing the reliability of this type of code is to introduce redundant bits into the code i.e.:

0000 = both channels off
0011 = channel 1 on
1100 = channel 2 on
1111 = invalid (or channel 1 and channel 2 both on where this condition is allowable).

All other codes = invalid.

As can be seen from this example, this technique is wasteful in terms of the number of bits required per channel, however, it does offer detection of an error in either (or both channels).

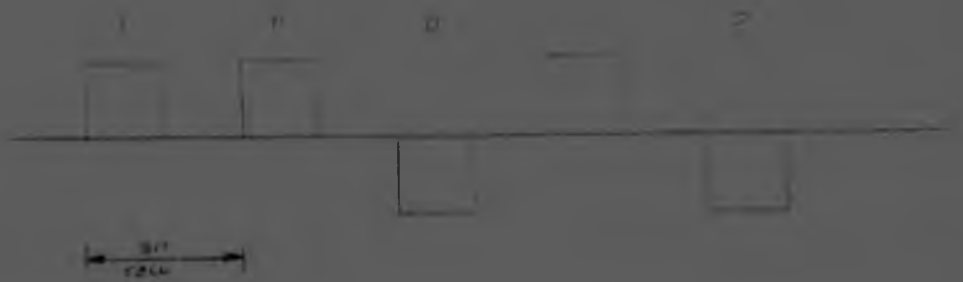

A. Return-to-Zero (RZ)



B. Non-Return-to-Zero (NRZ)



C. Split-phase (Manchester)

Digital Encoding Techniques

Figure 3.10.

The reasoning behind RZ and NRZ is self-evident from the diagrams. Split-phase encoding (sometimes called Manchester phase encoding) is basically NRZ multiplied by a clock having a frequency equal to the baud rate. It can be noted that with split-phase encoding, the half bit-cell zero-crossing is in one direction for a "1" and in the other direction for a "0". In comparing these waveforms, it must be noted that RZ and split-phase have the advantage that it is easy to extract the transmitter clock in the receiver, thus simplifying bit synchronisation. NRZ requires half the bandwidth of the other schemes whilst NRZ and RZ have the disadvantage that their power spectra are centred about DC and they are therefore more difficult to transmit. RZ also has the disadvantage that it has less energy per bit than the other schemes. It is thus evident that split-phase encoding is the superior technique in all respects except bandwidth requirement. In cases where a bandwidth limitation is not restrictive, split-phase encoding is the technique to use.

Where proportional control must be provided, a number of different approaches can be adopted. One alternative is to use one of the pulse modulation techniques such as pulse amplitude modulation (PAM), pulse duration modulation (PDM), and pulse position modulation (PPM). These are all basically "analogue" pulse modulation schemes. On the other hand we have the purely digital modulation techniques such as pulse-code modulation (PCM), differential pulse-code modulation (DPCM) and delta modulation (DM) which have the well known advantage that because of the discrete values allowable, where noise is smaller than the difference between these discrete levels, the noise can be eliminated. This advantage, coupled with the fact that fast, cheap analogue to digital converters (ADC's) are available, makes PCM one of the most popular techniques. However, PPM is still very popular in hobbyist circles where it is used extensively for

The reasoning behind RZ and NRZ is self-evident from the diagrams. Split-phase encoding (sometimes called Manchester phase encoding) is basically NRZ multiplied by a clock having a frequency equal to the baud rate. It can be noted that with split-phase encoding, the half bit-cell zero-crossing is in one direction for a "1" and in the other direction for a "0". In comparing these waveforms, it must be noted that RZ and split-phase have the advantage that it is easy to extract the transmitter clock in the receiver, thus simplifying bit synchronisation. NRZ requires half the bandwidth of the other schemes whilst NRZ and RZ have the disadvantage that their power spectra are centred about DC and they are therefore more difficult to transmit. RZ also has the disadvantage that it has less energy per bit than the other schemes. It is thus evident that split-phase encoding is the superior technique in all respects except bandwidth requirement. In cases where a bandwidth limitation is not restrictive, split-phase encoding is the technique to use.

Where proportional control must be provided, a number of different approaches can be adopted. One alternative is to use one of the pulse modulation techniques such as pulse amplitude modulation (PAM), pulse duration modulation (PDM), and pulse position modulation (PPM). These are all basically "analogue" pulse modulation schemes. On the other hand we have the purely digital modulation techniques such as pulse-code modulation (PCM), differential pulse-code modulation (DPCM) and delta modulation (DM) which have the well known advantage that because of the discrete values allowable, where noise is smaller than the difference between these discrete levels, the noise can be eliminated. This advantage, coupled with the fact that fast, cheap analogue to digital converters (ADC's) are available, makes PCM one of the most popular techniques. However, PPM is still very popular in hobbyist circles where it is used extensively for

radio control of models. It is beyond the scope of this thesis to look at proportional control techniques in any more detail than this. As can be seen from this brief discussion, where complexity increases, as in the case of a proportional control system a totally analogue solution becomes very unwieldy and a digitally based system is therefore necessary, even if one of the analogue pulse modulation encoding techniques is used.

3.4. Modulation and Demodulation of the Carrier Signal

A modulation technique must be chosen which will enable the information to be conveyed within the desired bandwidth. This modulation technique must be immune to the electrical noise found underground. The choice of technique is also dependent on whether analogue or digital encoding is used. Thus it is clear that all modulation techniques should be compared since this may influence the choice of encoding technique used. A quantitative comparison of the modulation technique is given in Appendix 4. The major choice is between an amplitude modulation (AM) technique and a frequency modulation (FM) technique. The actual modulation technique depends on whether the encoding is digital or analogue.

3.4.1. Advantages of Amplitude Modulation Technique

- 1) AM systems usually use less bandwidth than FM systems, and single side band (SSB) requires the least bandwidth of all.
- 2) The transmitter consumes less power than does an FM transmitter which has a constant carrier amplitude.
- 3) Synchronous demodulation (such as for SSB) does not exhibit a threshold.
- 4) At medium frequencies the carrier oscillator can be crystal controlled, and modulation is easily achievable.

radio control of models. It is beyond the scope of this thesis to look at proportional control techniques in any more detail than this. As can be seen from this brief discussion, where complexity increases, as in the case of a proportional control system a totally analogue solution becomes very unwieldy and a digitally based system is therefore necessary, even if one of the analogue pulse modulation encoding techniques is used.

3.4. Modulation and Demodulation of the Carrier Signal

A modulation technique must be chosen which will enable the information to be conveyed within the desired bandwidth. This modulation technique must be immune to the electrical noise found underground. The choice of technique is also dependent on whether analogue or digital encoding is used. Thus it is clear that all modulation techniques should be compared since this may influence the choice of encoding technique used. A quantitative comparison of the modulation technique is given in Appendix 4. The major choice is between an amplitude modulation (AM) technique and a frequency modulation (FM) technique. The actual modulation technique depends on whether the encoding is digital or analogue.

3.4.1. Advantages of Amplitude Modulation Technique

- 1) AM systems usually use less bandwidth than FM systems, and single side band (SSB) requires the least bandwidth of all.
- 2) The transmitter consumes less power than does an FM transmitter which has a constant carrier amplitude.
- 3) Synchronous demodulation (such as for SSB) does not exhibit a threshold.
- 4) At medium frequencies the carrier oscillator can be crystal controlled, and modulation is easily achievable.

3.4.2. Disadvantages of Amplitude Modulation Techniques

- 1) Its performance is seriously degraded in the presence of electrical noise.
- 2) In SSB, which gives the best overall signal to noise ratio (SNR) of AM systems, the demodulated signal can be distorted due to non-synchronism of the local oscillator in the receiver.
- 3) The circuitry for SSB is relatively complex.
- 4) The simpler demodulation techniques such as square-law demodulation and envelope demodulation do exhibit a threshold.

3.4.3. Advantages of Frequency Modulation Techniques

- 1) A very good quality demodulated signal can be obtained.
- 2) Above the threshold, the overall SNR of FM is higher than for any AM system provided that $\beta > 0,82$ (β = modulation index).
- 3) An FM receiver is far less susceptible to electrical noise.
- 4) The circuitry is relatively simple.
- 5) Since no information is contained in the amplitude of an FM system, higher efficiency power amplifiers can be used (e.g. class C) to reduce the power requirement over that of a linear power amplifier.

3.4.4. Disadvantages of Frequency Modulation Techniques

- 1) FM requires more bandwidth than AM where $\beta > 0,82$ (so that the benefit of the improved SNR can be obtained).
- 2) The carrier amplitude is constant and the result is that more power is consumed than is the case with AM. However, as mentioned in 3.3.3. this can be reduced by the use of high efficiency power amplifiers.

- 3) FM demodulation exhibits a threshold.
- 4) At medium frequencies a crystal controlled carrier oscillator cannot easily be used since the crystal frequency cannot be "pulled" sufficiently to achieve $\beta > 0,82$.

From Appendix 4 it can be seen that for $\beta = 1$ we obtain a small improvement in SNR by using FM rather than AM. To conserve bandwidth, and avoid congestion in the medium frequency range, it would appear that we should not go much above $\beta = 1$. The bandwidth in FM is given by Carson's rule.

$$B = 2(\beta + 1) f_m \quad (3.3.1.)$$

where B = required bandwidth to pass 98% of the power of the FM signal.

β = modulation index.

f_m = highest modulation frequency.

and where $\beta = \Delta f / f_m \quad (3.3.2)$

and Δf = maximum frequency deviation

Thus for $\beta = 1$, using equation (3.3.1) we get

$$B = 4f_m \quad (3.3.3.)$$

This is twice the requirement for AM (double sideband) and four times the bandwidth requirement for SSB. From Appendix 4 it can be seen that for an input SNR below 12 dB, SSB is better than FM (with $\beta = 1$), due to the threshold effect of FM. This would indicate that SSB is theoretically better than FM where low SNR's are to be expected. Disregarding a negative output SNR, FM concedes about 8 dB to SSB. If this is considered in the light of a dynamic range of 120 dB (i.e. 1V to 1 μ V) 8 dB is insignificant. However, what is significant is

the advantage of FM w.r.t. operation in an electrically noisy environment. It is well known that reliable relatively noise free demodulation of a signal can be achieved with FM due to the fact that noise generally introduces amplitude variations in the received signal and the FM limiter eliminates these amplitude variations.

The system will probably not be operating near the limits of communication range (i.e. near the threshold) since in most situations underground there are cables running between the transmission and reception points, and using medium frequencies, a fair amount of coupling into power cables will be achieved, thus extending the range well beyond 300 m. This means that the sacrifice of 8 dB when using FM is insignificant. The wider bandwidth required by FM (i.e. four times) is not prohibitive since the useful medium frequency spectrum for propagation underground extends from 100 kHz to 1 MHz. Spacing carriers at 25 kHz intervals still gives 36 different carrier frequencies - probably plenty for all requirements in one mine.

The other problem with FM, at medium frequencies, is the problem of providing a stable carrier oscillator that can be modulated sufficiently. However monolithic voltage controlled oscillators (or function generators) are available (e.g. XR 2206 - see appendix 2 for data sheet) which can be easily modulated by applying the modulating audio tone to one of the timing terminals. Another advantage of this integrated circuit is the fact that it provides a low distortion sine-wave output. This is particularly useful if a linear power amplifier is used since radiation of harmonics is then kept to a minimum, thus minimising intermodulation problems. The frequency of the oscillator is set by a resistor and capacitor, which means that it can very easily be changed by simply changing a resistor or capacitor (not difficult and expensive as in the case of a crystal oscillator).

A difficulty with such an oscillator (as opposed to a crystal oscillator) is its stability. This problem is not necessarily insurmountable and very stable oscillators can be designed if temperature compensating components (or components with known temperature coefficients) are used. However this is not necessarily required if the overall stability of the design circuit is good enough. Detailed design analysis and testing of the carrier oscillator is given in chapter 4 and appendix 2. The circuit diagram of a carrier oscillator which uses the XR 2206 is given in appendix 5 and 6.

CHAPTER 4ASPECTS OF RELIABILITY, RUGGEDNESS AND FAIL-SAFETY

As has already been stated, the overall reliability and ruggedness of the system, as well as its fail-safe performance, are extremely important. These aspects are clearly essential since the equipment could be controlling an expensive, potentially dangerous machine, however there are other less obvious reasons. The reliability and long term stability of the system is essential since mines do not have sufficient skilled electronics technicians who are capable of maintaining such equipment. It is also essential that these features be built into any electronic system used underground because it is important for the mining personnel to develop confidence in the equipment. Generally the little exposure they have had to electronic systems has only served to make them sceptical since much of this equipment has not been designed to stand up to the environment and handling underground.

Designing electronics which is reliable, fail safe and highly noise immune within laboratory conditions is one thing, but ensuring that the system offers the same features underground is quite another. So many other factors come into play, many of them not being of an electronic nature at all. These factors have already been mentioned in chapter 2. Many problem areas are overcome by "common sense" design techniques and experience gained (by the Chamber of Mines) over the years in the application of electronics underground. These aspects will not be considered here, but for completeness they are given in appendix 3.

Three aspects related to reliability, ruggedness and fail-safety are of particular importance and will be considered in greater detail here.

4.1. The Temperature Stability of the Circuitry

This aspect relates particularly to the reliability of the system, and is associated with the high ambient temperature underground. It necessitates careful design of all critical timing circuitry and selection of components which have a low enough temperature coefficient, to ensure that circuitry which has been set up in normal laboratory conditions (typically 22°C) should not be out of calibration at the operating temperature underground (anywhere between 25°C and 50°C - see chapter 2). It could be argued that equipment could be set up at the elevated temperature (in an environmental chamber in the laboratory), however it is clearly more convenient to set it up in normal laboratory condition (if this does not result in design difficulties). Since cooling fans cannot be used as a result of the sealing of the enclosures, power dissipation within the enclosure should also be kept to a minimum to avoid unnecessarily high temperatures.

4.1.1. Temperature Stability of the TWIN-T Oscillator

A TWIN-T oscillator circuit was constructed using polycarbonate capacitors and metal film resistors. The circuit of figure 3.7. was used. The temperature stability of the circuit was then measured and the results are shown in table 4.1.

TABLE 4.1.

Temperature Stability of TWIN-T
Oscillator

Temperature (°C)	f_1 (KHz)	f_2 (KHz)	f_3 (KHz)	f_4 (KHz)
25	4,000	3,000	2,000	1,000
30	4,002	3,001	2,001	1,001
35	4,003	3,003	2,002	1,003
40	4,006	3,005	2,003	1,004
45	4,008	3,006	2,004	1,005
50	4,010	3,007	2,005	1,006
Δf (%) between 25°C and 50°C	0,25	0,23	0,25	0,60

As can be seen from the graph of temperature variation as a percentage of the tone frequency, the maximum variation is 0,60%. This must be taken into account when the bandwidth of the tone decoder is determined.

4.1.2. Temperature Stability of the 567 Tone Decoder

The temperature stability of the 567 tone decoder is very well documented in the data sheet given in appendix 1. As can be seen from figure 8 (see appendix 1 - XR567 data sheet) the bandwidth variation with temperature is essentially zero (between 25°C and 50°C). Figures 9 and 10 (see appendix 1 - XR567 data sheet) show the temperature drift of the centre frequency for varying supply voltage. From figure 10 it can be seen that a supply voltage of 6V is optimum. Here the mean temperature coefficient is 0 whilst the standard deviation is + 50 PPM/°C. Thus we can accurately estimate the percentage variation in the centre frequency between 25°C and 50°C.

$$\begin{aligned} f_o (\%) &= \frac{TC \times T \times 100}{1 \times 10^6} \\ &= \frac{50 \times 25 \times 100}{1 \times 10^6} \\ &= \underline{0,13\%} \end{aligned}$$

where TC = temperature coefficient (PPM/°C)

T = temperature variation (°C)

This variation, together with the variation of the TWIN-T oscillator must be taken into account when the minimum bandwidth of the decoder is determined.

4.1.3. Temperature Stability of the FX 207/FX 307 Encoder/Decoder System

The typical frequency stability with respect to temperature is given in the data sheet as 0,01%/°C. Unfortunately the maximum limit on this specification is not given so measurements were carried out to ascertain practical values (including effect of external components). The results obtained are shown in table 4.2.

TABLE 4.2.

Temperature Stability of FX 207 8 Channel Encoder

Temperature (°C)	f _{1A} (KHz)	f _{1B} (KHz)	f _{1C} (KHz)	f _{2A} (KHz)	f _{2B} (KHz)	f _{2C} (KHz)
25	5931	5494	5046	4580	4157	3785
30	5930	5494	5048	4581	4159	3786
35	5929	5494	5050	4583	4160	3788
40	5928	5494	5052	4584	4162	3789
45	5927	5494	5054	4586	4164	3790
50	5926	5494	5056	4588	4166	3791
Δ f (%) between 25°C + 50°C	-0,08	0	0,20	0,17	0,22	0,16

The Δ f figures were calculated using the figures obtained at 25°C and 50°C. We see that the maximum variation due to temperature is 0,22%.

The typical variation (see data sheet - appendix 1) given is 0,01%/°C (i.e. 0,25% between 25°C and 50°C). To determine the maximum limit, tests would have to be carried out over a large number of samples. However, assuming a maximum of 4 times the typical probably ensures an adequate safety factor. Since the decoder is

all contained within an integrated circuit, it is not possible to measure variations in the upper and lower frequency limits which define the bandwidth of a channel. The data sheet (see appendix 1) again gives $0,01\%/^{\circ}\text{C}$ as the typical variation in frequency (i.e. $0,25\%$ between 25°C and 50°C). The upper and lower frequencies determining the bandwidth of a channel are determined by external resistors. The temperature coefficient for metal film resistors is $100 \text{ PPM}/^{\circ}\text{C}$ (see appendix 7) which also gives $0,01\%/^{\circ}\text{C}$. We again allow a maximum of 1 times the typical thus giving us 1% maximum variation in the case of both the encoder and decoder.

4.1.4. Temperature Stability of the Carrier Oscillator

The carrier oscillator circuit shown in figure 3.11 was tested to ensure adequate stability for use in remote control systems. The data sheet of the XR2206 is given in appendix 2. The frequency drift with temperature is shown in figure 9 of the data sheet, but the highest frequency shown is 100 KHz (with $R = 1 \text{ K}\Omega$ and $C = 0,01 \mu\text{F}$). It is recommended that $4 \text{ K}\Omega < R < 200 \text{ K}\Omega$ and $1000 \text{ pF} < C < 100 \mu\text{F}$ for optimum temperature stability. To use it at frequencies above 100 KHz , either the capacitor or resistor must be outside these limits. To ensure adequate stability, temperature tests must be carried out at a typical carrier frequency. Tests were carried out at 750 KHz and the results shown in table 4.3. were obtained.

TABLE 4.3.
Temperature Stability of the Carrier
Oscillator

Temperature (°C)	Carrier Frequency (KHz)
25	750,50
30	750,74
35	750,97
40	751,21
45	751,53
50	751,86
$\Delta f (\%)$ between 25°C & 50°C	0,18

Again the variation is calculated between 25°C & 50°C and is 0,17%. Carrier oscillator stability may be very important, and that given in table 4.3. may not be adequate. If that is the case, the drift of frequency with temperature can be eliminated by the selection of the correct combination of negative and positive temperature coefficient components. By using a series or parallel combination of two capacitors (of different temperature coefficients) this can be achieved.

A full derivation of the equations required to achieve temperature stabilisation of the oscillator is given in appendix 2. Utilising a parallel combination of two capacitors, the following equations apply:-

$$C = C_1 + C_2 \quad \text{--- (1)}$$

$$\alpha_c = \frac{C_1}{C} (\alpha_{C_1} - \alpha_{C_2}) + \alpha_{C_2} \quad \text{--- (2)}$$

The frequency of oscillation (of the 2206) is given by

$$f = \frac{1}{RC} \quad \text{--- (3)}$$

from which we get

$$\alpha_f = -\alpha_R - \alpha_C \quad \text{--- (4)}$$

Utilising capacitors to achieve the required temperature coefficient we get

$$\alpha_{C^{11}} = \alpha_C^1 + \alpha_f^1 \quad \text{--- (5)}$$

where α = temperature coefficient of a circuit element

f = frequency of oscillation

α^1 = initial values of temperature coefficients of circuit elements.

α^{11} = required final temperature coefficient

In order to stabilise the XR2206 oscillator, the initial temperature coefficient (TC) of frequency must be determined experimentally using a capacitor with a known TC of capacitance. The required final TC of capacitance (to give zero TC of frequency) is given by equation (5). Equations (1) and (2) can then be used to determine the required capacitance values for two capacitors in parallel.

The procedure worked very well in practice. The initial TC of frequency was determined by taking the average value of readings taken using temperatures 10°C apart (i.e. four values for TC were obtained using 25°C to 35°C , 30°C to 40°C , 35°C to 45°C and 40°C to 50°C as given in table 4.3. The required final TC of capacitance was then calculated using equation (5). This α_C^{11} is then used as α_C in equation

(2) thus solving for C_1 in terms of C . Equation (1) is then used to solve for both capacitor values. It was found that final values for TC of frequency of $< 10 \text{ PPM}/^\circ\text{C}$ were easily achievable.

In practical systems such as those described in chapters 5 and 6, it was found that such high stability is not necessary since the drift shown in table 4.3. was sufficiently small. Even though the transmitter carrier frequency can drift relative to the local oscillator in the receiver, this is not troublesome. The reason for this is that, with FM, when the carrier frequency drifts, the tones are distorted but the frequency of the tones remains unchanged. The tone decoders are therefore still able to detect the tone sequences and decode them correctly.

4.2. Immunity of System to Spurious Signals

This aspect relates directly to the operation of the system, as well as its reliability. It is important to ensure that the system is not triggered by spurious signals as this would definitely reduce the reliability of the system and could be a serious safety hazard. Immunity to spurious signals is also important since it is essential that the system be capable of operating in the presence of spurious signals or noise. If the system is not triggered by false signals, but fails to detect a correct signal in the presence of spurious signals the usefulness of the system will be very limited and its operation will be unreliable.

As mentioned before, when considering spurious signals, the main problem areas are intermodulation products and harmonics. The possible sources of noise and their characteristics must also be understood so that the system can be designed to be immune to them as far as possible.

4.2.1. Selection of Non-Harmonic Tone Frequencies

In the selection of tone frequencies it is essential to ensure that the chosen tone frequencies are far enough apart to avoid overlap between the bandwidths of the associated tone decoders. In the case of many decoders, it is also important to avoid the use of a tone frequency which is a harmonic of another tone frequency. As stated in the data sheet of the 567 (see appendix 1) the tone decoder will lock onto signals near $(2n + 1) f_0$ and produce an output for signals near $(4n + 1) f_0$ where $n = 0, 1, 2, \text{ etc.}$ The other important precaution to take (which is not mentioned in the data sheet) is to avoid selecting frequencies whose harmonics fall within the bandwidth of a tone decoder, e.g. a tone of 1 KHz could cause an output from a decoder tuned to 3 KHz. This problem is particularly troublesome where non-sinusoidal tones are used as a result of the fact that these tones contain harmonics of the fundamental frequency and although these are smaller in amplitude, they can cause an output. Even if low-distortion sine-wave tones are generated in the tone encoder, non-linearities in the transmitter and receiver will distort the tone thus increasing the harmonic content.

A set of frequencies which fulfils these requirements is given in table 4.4.

TABLE 4.4.

Non-Harmonically Related Tone Frequencies

f_o (KHz)	$2f_o$ (KHz)	$3f_o$ (KHz)	BW		f_{CH} (KHz)	f_{CL} (KHz)
			%	Hz		
1,100	2,200	3,300	11,78	130	1,165	1,035
1,300	2,600	3,900	10,84	141	1,371	1,229
1,500	3,000	-	10,09	152	1,576	1,424
1,700	3,400	-	9,48	162	1,781	1,619
1,900	3,800	-	8,96	171	1,985	1,814
2,100	4,200	-	8,53	180	2,190	2,010
2,400	-	-	7,98	192	2,496	2,304
2,750	-	-	7,45	205	2,852	2,647
3,150	-	-	6,96	219	3,259	3,040
3,600	-	-	6,51	235	3,718	3,482
4,050	-	-	6,14	249	4,174	3,925

where f_o = tone frequency

$2f_o$ = second harmonic

$3f_o$ = third harmonic

BW = bandwidth of tone decoder

f_{CH} = upper frequency limit of tone decoder

f_{CL} = lower frequency limit of tone decoder

None of the frequencies $2f_o$ and $3f_o$ fall within the bandwidth of other higher frequency channels. Also, there are no tone frequencies which are at $3f_o$ and $5f_o$ (and higher harmonics) of a lower frequency channel.

4.2.2. False Triggering due to Intermodulation

Intermodulation products result when two or more signals passing through a system simultaneously react with each other (i.e. modulate each other) due to non-linearities in the system. A signal at f_2 is modulated by the signal at f_1 and its harmonics, thereby yielding intermodulation products at $f_2 - f_1$, $f_2 + f_1$, $f_2 - 2f_1$, $f_2 + 2f_1$, $f_2 - 3f_1$, $f_2 + 3f_1$, etc.

In the case of the type of systems discussed so far, intermodulation will be a potential problem area only where similar systems are operated in the same area (i.e. within range of each other) of a mine. The intermodulation can occur either at the carrier frequencies or at the tone frequencies.

Where more than one carrier frequency is used in the same area, the frequencies must be chosen so that they do not generate intermodulation products within the bandwidth of one of the receivers (or a third receiver).

For example, if carrier frequencies of 300 KHz, 400 KHz, and 700 KHz are all in use, the 300 KHz and 700 KHz signals arriving at the front-end of the 400 KHz receiver would generate intermodulation products. The difference frequency is:-

$$f_2 - f_1 = 700 - 300 = \underline{400 \text{ KHz}}$$

This frequency would pass straight through the receiver and could produce a spurious response if the 400 KHz system and one of the other systems used the same tone frequencies (and sequences).

By careful selection of carrier frequencies this problem can be avoided. It would be defeating the object to limit the choice of tone sequences since the whole reason for going to a second frequency would be to re-use tone sequences that have already been used. Another way of avoiding carrier intermodulation would be to stick to one carrier frequency, and increase the number of tones in a sequence to a number which would provide for all the possible systems in that area.

Tone intermodulation is more difficult to cope with since numerous tone frequencies and combinations exist. A computer analysis program would have to be written to compute a list of all valid tone frequency sequences which would ensure no clashes. With the experimental systems developed at the Chamber of Mines, the need never arose to develop a computer program since only a small number of systems were in operation in one area. The required analysis of intermodulation products was carried out manually.

4.3. A Rugged Switch Assembly

The whole aspect of rugged design is a particularly important one in the context of systems to be used in the mines. The success of a system depends on meticulous care being taken with every last detail which could possibly affect the ruggedness of the system.

It is also important to see the role of such a system in the correct perspective. The mining personnel have a job of work to do, and remote control systems must assist them in doing that job. Miners are used to handling heavy machinery and working in conditions which are often adverse.

It is therefore essential that the system should be in keeping with the environment and should not require extraordinary care in handling. Where switches or pushbuttons are used, they should not be delicate micro-miniature types - one of the main reasons for this is the fact that miners often wear thick leather gloves.

The most stringent requirement, with regard to ruggedness, definitely applies to any components, such as switches and connectors, which must be exposed to the outside world. Besides withstanding rough handling, they must also be immune to dust and grit, particularly quartzite grit (which is highly abrasive). These components must also be waterproof, and gold plated contact surfaces should be used throughout. In most cases "mil-spec" connectors are suitable for use underground, however where switches are required, the solution is not quite as simple. The rough handling and quartzite grit most often destroy the switch. Where rubber boots are used to keep out moisture and grit the continual use damages the rubber boot within weeks. If switches that don't require rubber boots are used, the quartzite grit works its way into the switch and eventually results in its failure. In the case of mil-spec pushbuttons with built in o-ring seals they have been found to fail within a week. The reason for this is that quartzite grit works into the small gap between the shaft and the housing causing the switch to jam.

The only solution left is to make custom components or to modify existing switches. The latter approach was adopted since it is the simpler of the two. A standard mil-spec pushbutton is used (with it's rubber boot) and a dummy panel and pushbutton protect the actual pushbutton and rubber boot.

The pushbutton assembly is shown in figure 4.1.

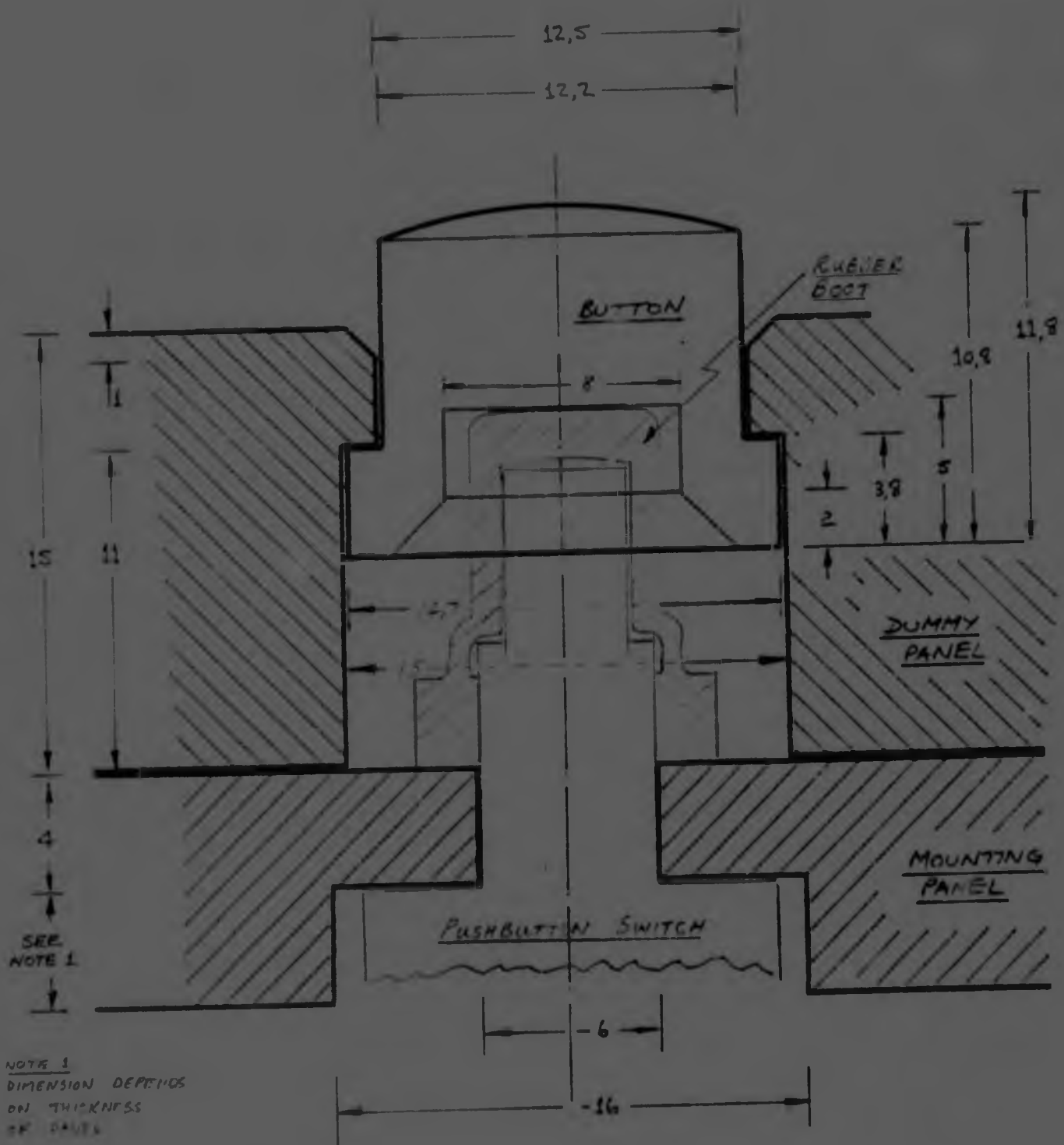

Pushbutton Switch Assembly
Figure 4.1.

The success of this scheme is dependent on the use of a "soft" plastic material such as polyvinylchloride (PVC) for the dummy panel and pushbutton. The clearance between the pushbutton and the dummy panel (0,15 mm) is important (this is the minimum clearance which should be provided). Since the clearance is "large" and the material soft, the inevitable ingress of grit does no more than scour the sides of the pushbutton and hole (eventually enlarging the clearance).

This type of pushbutton is in widespread use now on remote control systems underground, and has proved highly reliable. The systems described in chapters 5 and 6 have both made use of this switch assembly. The only failures have been in cases where the clearance was too small between the pushbutton and the dummy panel. Some of the systems have already been in operation since 1977.

---o0o---

CHAPTER 5

A TWO CHANNEL MONORAIL CONTROL SYSTEM

As mentioned earlier, systems underground are often operated by a rather indirect method. A monorail conveyor system being used in a Chamber of Mines experimental mechanised stope was just such a system.³¹ Figure 5.1. illustrates the system.



Monorail Conveyor System

Figure 5.1.

The purpose of the monorail conveyor is to convey materials and equipment to and fro between the upper level and the strike gullies leading to the stope. The monorail conveyor operates in an inclined gully (dip gully) which is about 2,5 m high and about 2 m wide. Once the monorail conveyor is installed in the dip gully (suspended from the roof (or hanging)) the conveyor frame is at about shoulder height. As such it is a potential hazard to mining personnel who have to use the dip gully as an access route to and from the stope. For this reason law requires that a "guard boy" always accompanies the conveyor.³² The conveyor is hauled up and down by an electric winch situated at the top of the dip gully.³³

The original approach to the problem was to provide pushbuttons at each strike gully. These pushbuttons would all be connected to a bell located at the top of the gully near the winch. By this means the "guard boy" would signal to the operator indicating what action was required. As a safety measure an emergency pull wire ran the full length of the main gully, enabling the "guard boy" to stop the machine at any time if the bell system failed. Due to the amount of noise (acoustic) present in a mining environment, confusion was often caused by misinterpretation of the bell signals. Another problem with the system was the length of the gully (up to 300 m) and the harshness of the environment. These factors made the possibility of damage to the bell cable a fairly likely one. Finally, since it was only feasible to mount pushbuttons at each strike gully, time was wasted in scrambling to the nearest pushbutton. This time could have been critical in an emergency.

A radio remote control system does away with all these disadvantages. The system is operated by the "guard boy" via a transmitter communicating with a receiver situated

near the winch (at the gully box which provides power to the winch). The receiver controls relays which in turn operate contactors, thus controlling the operation of the winch. The emergency pull-wire was kept as a back-up safety measure to be used in the event of a failure in the remote control system.

The following advantages can be identified:-

- 1) The human link in the chain is eliminated (i.e. the winch operator) thus avoiding any chance of confusion.
- 2) The system does away with the cables right down the gully, thus providing a far more rugged and reliable solution.
- 3) Installation and maintenance costs are reduced since cabling does not have to be laid (and maintained) all the way down the gully.
- 4) Reduction of time wasted in getting to the nearest pushbutton, since operation is instantaneous.
- 5) Emergency situations are handled rapidly.

A number of disadvantages are however apparent:-

- 1) Repairs to the system require the skills of an electronics technician. - This disadvantage can however be minimised by maintaining a high degree of modularity in the design, thus meaning that on-site repairs could be done by less skilled personnel.
- 2) Higher initial cost than cable/bell system - this is however offset by the saving in usage of manpower and the increased reliability, which saves on repair costs and loss of production caused by failures.

Thus it can be seen that very definite advantages can accrue from the use of radio remote control in this situation. At the time that this application arose, radio remote control had not been used underground in South African Gold Mines. Since this was an experimental stope it was decided that this would prove a good test bed for radio remote control systems.

5.1. System Specifications

This system requires two on/off channels and is required to operate in a fail safe fashion i.e. a signal must be continuously transmitted to maintain operation in a forward or reverse direction. It is required that the transmitter be hand held and that it should operate from re-changeable batteries for an 8 hour shift. The receiver must operate from a 24 V ac supply and provide two uncommitted relay contacts, one to operate the forward contactor and the other to operate the reverse contactor. These contactors supply power to the winch. A response time of 500 ms is adequate for this system and a range of up to 300 m is required (not necessarily line of sight). The other specifications are common to all radio remote control systems in mines and are covered in Chapter Two.

5.2. System Design

Possibly the most difficult part of the system design revolved around achieving high reliability and a mean time between failures (MTBF) of approximately 6 months.

To protect against the humidity and corrosiveness of the atmosphere, two measures were taken. Firstly, "hose-proof" enclosures were used to house the electronics. These enclosures withstand a direct jet of water, but are not submersible. It was felt that it should not be

essential to have a waterproof (i.e. submersible) enclosure since maintaining it in that condition would present problems due to the difference in pressure between surface and underground and also due to the fact that switches and connectors must be mounted on the sides of the enclosure. Wherever switches and connectors were mounted through the enclosure, Dow Corning silastic sealant was used to seal off the hole. Secondly, all the electronics within the enclosure was coated with a Dow Corning conformal coating. This coating has very good moisture resistant properties, and protects the electronics against any moisture which penetrates into the enclosure. This coating protects the components against corrosion. The enclosures were made of fibre filled polyester which has very good mechanical strength and is also non-corrosive. Any external attachments were either made of stainless steel or aluminium. Since the equipment was prototype equipment it was not felt that it was necessary to substitute the aluminium (since aluminium only corrodes over a long period of time).

The power dissipation in the transmitter was approximately 1 W (since the output power is 1 W and the transmitter is approximately 50% efficient) and this did not cause excessive temperatures within the transmitter enclosure (since the enclosure has a large surface area). In the receiver a 12 V dc supply was decided upon. This choice was governed by the integrated circuits used and the fact that where battery operation was desirable (not in this application), 12 V operation was most suitable. Since a 24 V ac supply was available this meant that if a series regulator was used, the large differential voltage across the supply would result in excessive power dissipation within the enclosure. Considering the current consumption in the receiver which is typically 300 mA, this would amount to:-

$$\begin{aligned}
 P_{DIS} &= (V_{AC} \times \sqrt{2} - V_{DC}) I_{DC} \\
 &= (24 \times \sqrt{2} - 12) (0,3) \\
 &= \underline{5,58 \text{ W}}
 \end{aligned}$$

It is not desirable to dissipate this much power in the sealed enclosure and for this reason, a switching regulator was used in the receiver.

To ensure reliable operation at the elevated temperatures found underground, the system was tested for operation over the range from 25°C to 50°C. Furthermore it was desirable that all calibration should be carried out at laboratory room temperatures and that no re-calibration should be necessary at the operating temperature. For this reason, components with low temperature coefficients were used in all critical timing circuitry. The other problem area was related to the provision of reliable switches. These aspects have already been covered in detail in Chapter 4.

The transmitter was handheld and the receiver was mounted on a fixed gully-box and it was therefore not necessary for the system to withstand vibration. Figure 5.2. shows the transmitter in use whilst figure 5.3. shows the receiver mounted to a gully box.



Dip-Gully Conveyor Transmitter

Figure 5.2.



Dip Gully Conveyor Receiver

Figure 5.3.

To ensure reliable operation in an electrically noisy environment, power supply de-coupling was used on all printed circuit boards, as well as on the power supply. The system was also tested under "noisy" conditions. It was found to operate perfectly next to an arc welding machine. It was also tested in the presence of other radio transmitters operating in the same frequency range and no malfunctioning was found to occur.

A medium frequency radio link and a two tone sequential tone encoding scheme were used (see chapter 3 for more detail). As discussed in Chapter 3 and Appendix 1 where the bandwidth of the tone decoders equals 5%, the tone frequencies should be $> 1,265 \text{ Hz}$ to ensure that the two tone sequential decoder operates within 158 ms. The



Dip Gully Convevor Receiver

Figure 5.3.

To ensure reliable operation in an electrically noisy environment, power supply de-coupling was used on all printed circuit boards, as well as on the power supply. The system was also tested under "noisy" conditions. It was found to operate perfectly next to an arc welding machine. It was also tested in the presence of other radio transmitters operating in the same frequency range and no malfunctioning was found to occur.

A medium frequency radio link and a two tone sequential tone encoding scheme were used (see chapter 3 for more detail). As discussed in Chapter 3 and Appendix 1 where the bandwidth of the tone decoders equals 5%, the tone frequencies should be $> 1,265 \text{ Hz}$ to ensure that the two tone sequential decoder operates within 158 ms. The

upper tone frequency limit is determined by the bandwidth used for transmission. Limiting the upper frequency to 4 KHz means that bandwidth requirements are kept to a minimum, whilst still allowing the choice of twelve different tone frequencies. (See Chapter 4). Irrespective of frequency all capacitors in the tone decoder are fixed, thus making stocking of components simpler. This means that the tone decoder bandwidth varies from 11,78% (of centre frequency) at 1,1 KHz to 6,14% at 4,050 KHz (see Chapter 4). The tone frequencies were chosen so that the tone bandwidths do not overlap. Since the bandwidth is 11,78% (i.e. > 5%) at 1,1 KHz, the number of cycles required is reduced to 40 (from 100). Thus the system will still respond within 158 ms.

As discussed in Chapter 3 and Appendix 4, FM is preferable to AM for a number of reasons, and as a result FM was used in this system.

Many of the propagation tests carried out at the Chamber of Mines utilised equipment with a transmitter output power of 1 W and a receiver sensitivity of $1\mu V$. Those two specifications were thus used as preliminary design goals for this system. Since this was the first experimental system, it was not considered important to look at this aspect in more detail as the evaluation of the techniques for radio remote control was more important. At a later stage the sensitivity could be improved, thus enabling one to reduce the output power requirement.

Another important aspect of the circuit design was the use of components that were readily available. For this reason a bandwidth of 13 KHz was used since crystal filters are readily available with this bandwidth. They are centered at a frequency of 10,7 MHz. An advantage of choosing an IF frequency that is well above the

carrier frequency is that image frequencies are all above the IF frequency. This means that front-end filtering in a receiver is non-critical. A 13 KHz bandwidth with a maximum modulation frequency of 4 KHz gives (From equation 3.3.1.)

$$\beta = \frac{B}{2f_m} = 1$$

$$= \frac{13}{2(4)} = 1.625$$

$$= 0.63$$

Although this means that there is no theoretical advantage (as far as signal to noise ratio is concerned) to be gained by using FM rather than SSB, the other advantages discussed in Chapter 3 still hold. In systems where an improvement in signal to noise ratio, (SNR) is required, a wider bandwidth than 13 KHz can be used, however the high-Q antenna might then pose a problem.

The necessary fail-safety required for this system is provided by the two spring-loaded pushbuttons on the transmitter. Either of these pushbuttons has to be pressed continuously to operate the winch. If neither is pressed, the winch will not operate so that if something should happen to the operator, the winch will stop. Similarly, if both buttons are pressed simultaneously the winch will not operate. A frequency in the range between 100 KHz and 1 MHz was used, and a frequency of 700 KHz will be used as representative in further discussions. With the requirement for portability, together with the frequency range of operation, a body loop antenna was decided upon. These loops can be made of an appropriate size so that they can hang around the body of the operator, and they can provide communication over 300 m with a 1 W transmitter and a 1 μ V sensitivity receiver.

5.3. Description of the System

In describing the system, reference will be made to the block diagram shown in Figure 5.4. Circuit details are given in Appendix 5, and these can be referred to where necessary. The operation of the system is as described below.

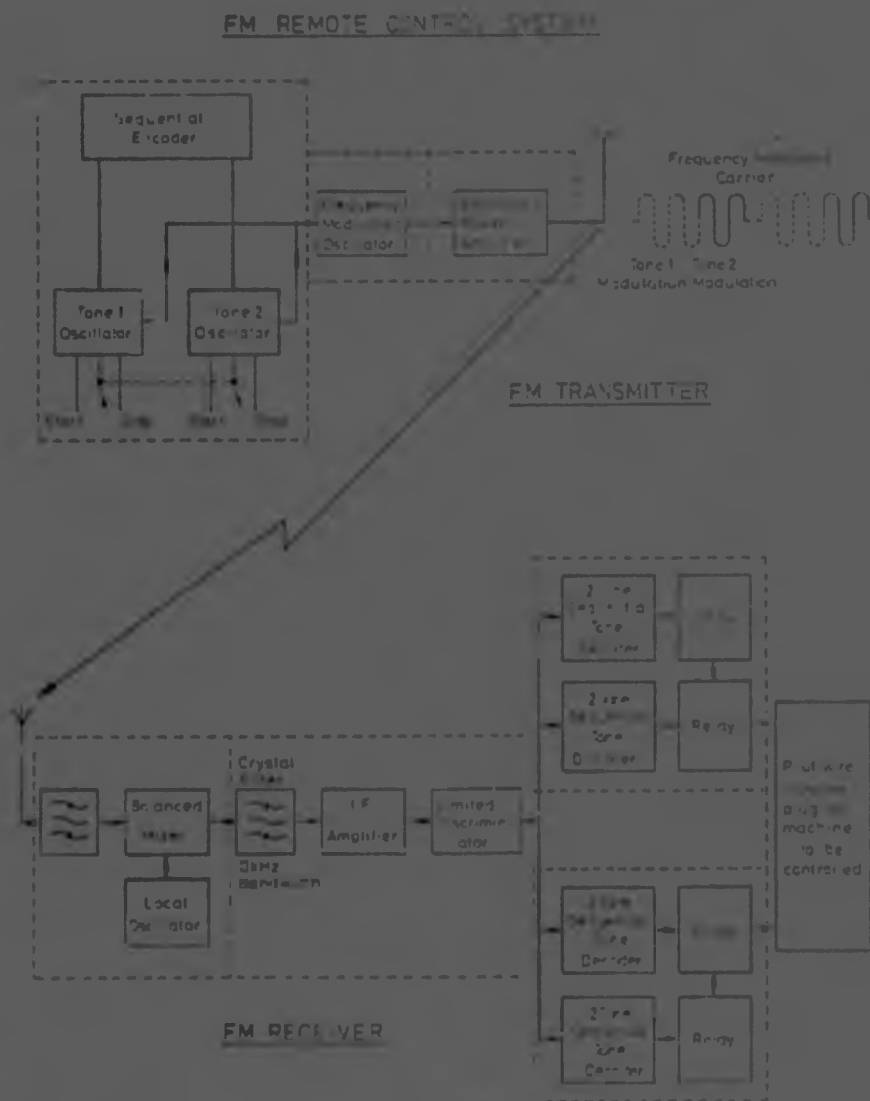

Block Diagram of a Two Channel Monorail Conveyor Remote Control System

Figure 5.4.

The sequential encoder switches on tone 1 oscillator and then tone 2 oscillator, producing a tone burst consisting of the two sequential tones of different frequencies. The tone burst has a duration of approximately 150 ms and is repeated every 500 ms for as long as either the forward or reverse buttons are depressed. The frequencies of tones 1 and 2 depend upon whether the forward or reverse buttons are pressed. In all there can be up to 4 different frequencies.

The "tone burst" frequency modulates the 700 KHz carrier oscillator and the frequency modulated signal is then amplified and fed to the loop antenna.

The tone-modulated radio frequency signal is received and passes through a bandpass filter after which it is mixed with a 10 MHz local oscillator signal on the balanced mixer, producing a sum frequency of 10,7 MHz. The IF signal is then amplified and passes to the limiter/discriminator where it is demodulated to reproduce the sequential audio tones. These tones pass in parallel to four sequential tone decoders (two for forward control and two for reverse control). When the tones are detected in the correct sequence the decoders actuate the relay which in turn activates the machine motor via a contactor in the electrical box on the gully.

To ensure reliability, the encoding system had to be complex enough to ensure that false operation was avoided, and yet not so complex as not to operate. Encoding with two sequential tones and decoding using two identical sequential tone decoders for each control provides a suitable compromise. This encoding technique is achieved with simple circuitry which ensures the long term reliability of the system. The sequential tones provide immunity to false operation, since to operate the machine, the two tones have to be

received in the correct order, and each has to be of sufficient duration. In addition, the second tone has to follow immediately after the first tone. It is also necessary that both tone decoders accept the signal before a control action is taken. Where one develops a fault no further controls are initiated.

The 2206 carrier oscillator discussed in Chapters 3 and 4 was used.

To conserve battery power the transmitter is only switched on when one of the control buttons is pressed. Furthermore, the power to the input stage of the broadband power amplifier is switched on only during each tone burst and hence the carrier is only transmitted during this period thus conserving battery power.

In the receiver, a low-noise field effect transistor balanced mixer has been used. These mixers can handle a very wide dynamic range ($> 100\text{dB}$), a prerequisite where the transmitter and receiver can be in close proximity (within a few metres). These features of this mixer enable it to be used without a front end radio frequency amplifier. All the necessary amplification and filtering can therefore be placed in the IF stages. The selectivity is provided by a six pole integrated crystal filter and the tuned IF amplifiers. Since all the selectivity is achieved in the IF circuits (10,7 MHz) no modification or retuning is needed here if the carrier is changed (only the crystal of the local oscillator needs to be changed). A front-end bandpass filter is used, but this filter could be replaced by a low-pass filter with little reduction in sensitivity.

Part of the IF amplifier, as well as the limiter discriminator and audio preamplifier are contained in an integrated circuit (CA 3089 or TDA 1200 - see appendix 7)

which also provides automatic gain control (AGC) and automatic frequency control. The AGC is compatible with dual-gate mosfet transistors, which have been used in the IF amplifier.

The tone decoder utilises the 567 tone decoder (see Chapters 3 and 4 and appendix 1). Two tone decoders are connected so that two sequential tones can be detected. Two identical sequential tone-decoder circuits operate in parallel for each control function. The contacts of the relays in the output circuit are connected in series so that the system is more reliable, as the winch motor can only operate if both decoders detect the tones.

5.4. Results obtained in use

A number of these systems have been in use at Doornfontein Gold Mine for a period of about 4 years. 3 or 4 systems operate on the same carrier frequency in the same vicinity using different tone frequencies. No reports of interference between these systems has ever been recorded. Other identical systems operate in the same vicinity, but on different carrier frequencies, and this has also not posed any problems (see Chapter 4 for detailed discussion). Perfect operation over distances well in excess of 300 m has been achieved using small loop antennas (see appendix 8). The only unreliable part of the first prototype system has been the loop antennas on the portable transmitters. These loop antennas consisted of the loop and an interconnecting coaxial cable to the transmitter (see Figure 5.2. underside of transmitter).

As a result of the rough handling they receive, they are subject to fairly frequent failure (approximately once every 2 to 3 months). The failure usually occurred in the interconnecting coaxial cable.

With this improvement the system has been favourably received by the mining personnel and has proved that reliable radio remote control can be provided. The system has increased productivity, reduced mining costs and improved the safety of personnel.

As a result of these findings, later transmitters used a loop antenna similar to that used with the portable transceivers developed at the Chamber of Mines Research Laboratories. The loop looked like a bandolier and was attached directly to the transmitter. The antenna is slung diagonally across the body with the transmitter upright on the chest of the operator.

---000---

CHAPTER 6A MULTI-CHANNEL IMPACT RIPPER CONTROL SYSTEM

The need to control more than two functions has arisen as a result of the design of new experimental mining machines such as impact rippers. These machines can typically have up to 16 different movements which must be independently and simultaneously controlled. All controls are of an on/off type - they control electrically operated hydraulic valves which can only be open or closed.

The machine operator must be free to move around the machine so that he can control it from the best vantage point. Many of the current machines are controlled via a cable connected to the machine. However, it is desirable to do away with the cable for a number of reasons.

- 1) It is often damaged in the harsh environment of the stope.
- 2) It restricts the free movement of the operator - in some situations the operator is not able to position himself at a point from which he can clearly see the machine. This is as a result of props and other obstructions in the stope, as well as the restricted height in the stope (approximately 1 m).
- 3) As the machine moves along the face the operator has to continually thread the cable round the props, and this is time consuming and awkward.

A radio remote control system does away with all these limitations. The multi-channel radio remote control system developed enables the operator to control all the machine movements via the transmitter, and operate more than one control simultaneously. In addition the machine power pack can be switched off from the transmitter. This is useful in the case of an emergency or failure of the machine. The only operation that cannot be carried out from the transmitter is the starting of the power pack. It could prove dangerous if this could be done as this would enable somebody with the transmitter to start the machine without the machine being in view. Therefore, for safety reasons, starting of the power pack must be done manually from the machine.

Figure 6.1. shows the transmitter in use underground.

(Note the restricted height and the presence of many props). A prototype receiver is also shown - this receiver did not use the pushbutton assembly discussed in chapter 4.



The Multi-channel Impact Ripper Remote Control System

Figure 6.1.

6.1. System Specifications

The system was required to provide control of 13 on/off channels and was required to operate in a fail-safe fashion, i.e. a signal must be continuously transmitted to maintain the machine's hydraulic power pack in operation.

The transmitter was required to be portable and battery operated. The requirement for portability does not mean that it has to be handheld. The machine is normally operated with the transmitter placed on the ground. The battery should be removable to simplify recharging, and should allow at least 8 hours of normal operation. The receiver was required to operate from a 27 V ac supply available on the machine. The operation of each channel had to be via a 2A relay which would supply a full wave rectified supply (from the 27V ac supply) to each hydraulic valve. In a preliminary test carried out on the machine, the rate of movement of certain functions required a response time of 300 ms for accurate control and positioning. A maximum range of 10 m was all that was required for this system, since in the stope the restricted height (1 m) and cramped conditions prohibit good visibility at distances > 10 m.

Based on the experience with loop antennas (as mentioned in Chapter 5) it was desirable that if at all possible, the transmission antenna should be inside the transmitter.

This would definitely increase the overall reliability of the system. The receiving antenna had to be robust and mounted firmly on the impact ripper. It was not to be affected by the large amount of metal close to it. Both the receiver and its antenna had to withstand vibration since they were to be mounted on the impact ripper itself.

The main mining functions of the machine were required to be operated by a joystick, whilst the less used functions could be operated by pushbuttons. In view of the harshness of the environment in the stope, particularly the abrasiveness of the quartzite grit, attention had to be paid to providing reliable push-buttons and joystick.

The other specifications of this system were in common with all radio remote control systems in mines and have been covered in Chapter 2.

6.2. System Design

Many of the aspects of the system design for this application are the same as those for the monorail system, and only those aspects which differed will be considered here.

Although the specification only called for a range of 10 m, the same RF design was used as for the monorail system. Modules developed for the monorail system, and other similar two channel systems, were used directly.

Since more than two channels were required, and the response time had to be faster than for the two channel system, the alternative analogue techniques discussed in Chapter 3 were used. To provide more than 8 channels (one FX 207) two FX 207 integrated circuits were sequenced to provide a 6 tone code. The sequence of 6 tones provided a maximum of 64 channels. Although this is far more than the 13 channels which were required, it did prove convenient later on. This stemmed from the fact that with a system like this it has been found practical to provide a complete back-up system to replace the system in operation when this one failed.

If both sets are identical, and both transmitters are in operation at the same time, this could lead to confusion since the machine could be controlled by either transmitter. Since the system has the capability to control 64 channels, one system can be wired to respond to certain channels whilst the other system responds to other channels, thus avoiding any chance of confusion.

The details of the encoding/decoding scheme are given in Appendix 1. As mentioned in Chapter 3, the technique used by the tone decoders is a period sampling technique. This technique has a faster response time, but is however more susceptible to noise than a phase-locked loop tone decoder, such as the 567. In testing of these period sampling tone decoders, it was found necessary to use more than the recommended 12 cycles of each tone. The principle of operation must be understood to clarify this. The decoder has a certain gate period (usually set at twice the tone period of the encoder) during which it searches for 10 periods which fall within the limits for the desired tone frequency. If only 12 cycles are transmitted, three corrupted periods result in the decoder not detecting the tone. When the tone sequence consists of 6 tones, there is a 6 times greater likelihood of this occurring. Since the receiver had to run off the same electrical supply as the electric motor in the power pack (about a 50 kW motor) measurements of noise were taken in situ underground. The noise on the receiver demodulator output consisted of a series of spikes repeating at a frequency of 100 Hz. The amplitude of the spikes was about 3 V peak to peak, and their duration was about 5 ms. Other random noise components, consisting mainly of spikes, were also present, thus inhibiting decoding of the tone sequence far too frequently for reliable operation. Unfortunately the spectrum of the noise could not be measured because no portable, battery operated, rugged spectrum analyzer was available for

underground.

When 20 cycles of each tone were transmitted it was found that the decoders operated far more satisfactorily, however it was still found that the occasional tone sequence was not decoded. Observations showed that it was very rare that two tone sequences in a row were incorrectly decoded. It was thus decided to transmit two tone sequences per channel within the required 300ms. An appropriate delay was then set on the relay driver lines in the receiver, such that two successive tone sequences had to be incorrectly decoded before the channel relay dropped out. This did away with the problem that relays chattered, thus giving poor control. Since the required range was only 10 m, it was found possible to utilise a small loop antenna enclosed within the transmitter box. This would clearly be more reliable than the "body" loop antennas used with the mono-~~ball~~ system. The receiver antenna posed a problem since it had to be robust and also work well in close proximity to the machine (large mass of steel). The very limited amount of space available on the machine for mounting the receiver and antenna necessitated the use of a compact antenna. A ferrite rod antenna was constructed, and tests were carried out in situ underground giving very satisfactory results. To make the antenna robust, it was surrounded by soft rubber within a PVC tube, and this tube was in turn mounted within another larger PVC tube. A layer of sponge rubber was used between the two tubes. The ends of the tube were sealed to prevent ingress of moisture.

It was used for this system as well, however, to accommodate the higher tone frequencies (up to 6 KHz - see Appendix 1) required for compatibility with the desired response time, a 30 KHz bandwidth was used. Crystal filters with this bandwidth and centred at 10.7 MHz, are commercially available. As mentioned in Chapter 3

these tone decoders operate up to 7 KHz. This then gives:-

$$\begin{aligned} \beta &= \frac{B}{2LW} = 1 \\ &= \frac{30}{2(7)} = 1 \\ &= \underline{1,14} \end{aligned}$$

This is greater than 0,82 and there is therefore an improvement in SNR over that obtained with SSB.

A fail-safe feature of the system was the incorporation of a signal which had to be continuously transmitted to maintain the machine's power pack in operation. This was easily provided via the "stop" function on the transmitter. This function was operated in reverse to all other functions in that when the "stop" push-button is pressed this breaks the transmission of the tone sequence code for this channel. In other words, this code is transmitted continuously and energizes the stop relay allowing the power pack to run once it has been manually started at the machine. If for any reason transmission is lost, the relay de-energizes, and thereby stops the machine.

A frequency of 750 KHz was used for this system.

6.3. Description of the system

In describing the system, reference will be made to the block diagram shown in Figure 6.1. Circuit details are given in Appendix 7, and these can be referred to when necessary. The operation of the system is described below.

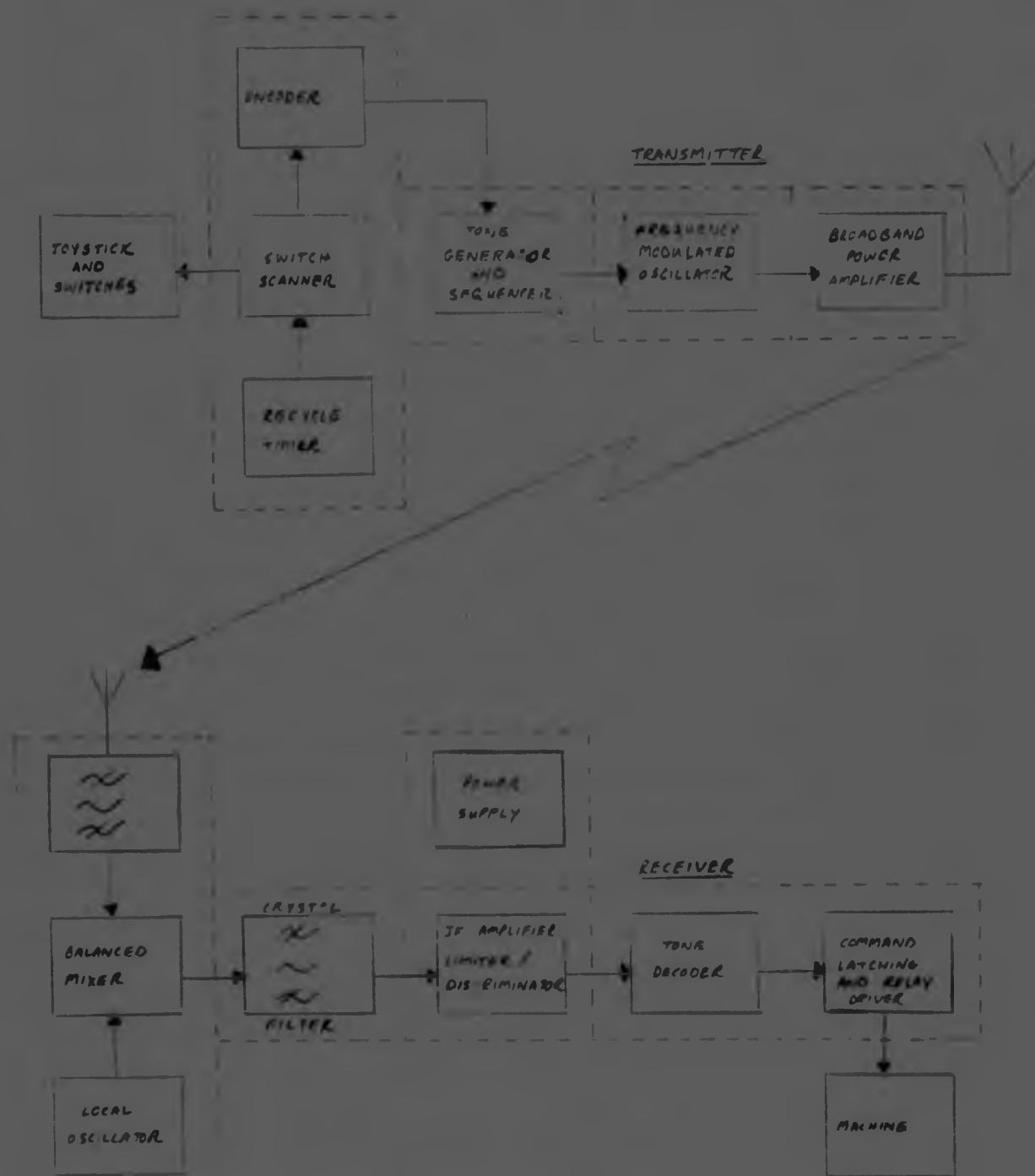

Block Diagram of a Multi-channel Impact Ripper Remote Control System

Figure 6.2.

The switch scanner scans all the switches after every recycle time of 150 ms, searching for a switch which has been operated. When one is found, the encoder then strobes the tone generator and sequencer, causing it to generate two "three-tone group codes" in sequence, thus producing a sequence of six audio tones, giving 64 possible channels.

The technique of using two "three-tone group codes" greatly simplifies the switch encoding in the transmitter, and the decoding and relay driving in the receiver, since both the switches and relays are arranged in an 8 x 8 matrix and as a result each "three-tone group code" directly selects a particular row or column of the matrix. The six-tone tone-burst, of 37 ms duration, frequency modulates the 750 KHz carrier oscillator. It must be noted that with a recycle time of 150 ms and tone bursts of 37 ms duration, only 4 channels can be transmitted simultaneously, however, this is not considered a limitation since it is not practically possible for the operator to control more than two functions at a time. The frequency modulated signal is then amplified and fed to the antenna.

The tone modulated radio frequency signal is received and passed through a bandpass filter, after which it is mixed in a balanced mixer with a 9,95 MHz local oscillator producing a sum frequency of 10,7 MHz. This IF signal is then amplified and passed to the limiter discriminator where it is demodulated to reproduce the audio tone-burst. The tone decoder produces the output code corresponding to that at the input to the encoder. This code is then latched by the appropriate relay driver for twice the recycle time. The relay operates the hydraulic valve which controls the machine.

The switch scanner scans all the switches after every recycle time of 150 ms, searching for a switch which has been operated. When one is found, the encoder then strobes the tone generator and sequencer, causing it to generate two "three-tone group codes" in sequence, thus producing a sequence of six audio tones, giving 64 possible channels.

The technique of using two "three-tone group codes" greatly simplifies the switch encoding in the transmitter, and the decoding and relay driving in the receiver, since both the switches and relays are arranged in an 8 x 8 matrix and as a result each "three-tone group code" directly selects a particular row or column of the matrix. The six-tone tone-burst, of 37 ms duration, frequency modulates the 750 KHz carrier oscillator. It must be noted that with a recycle time of 150 ms and tone bursts of 37 ms duration, only 4 channels can be transmitted simultaneously, however, this is not considered a limitation since it is not practically possible for the operator to control more than two functions at a time. The frequency modulated signal is then amplified and fed to the antenna.

The tone modulated radio frequency signal is received and passed through a bandpass filter, after which it is mixed in a balanced mixer with a 9.95 MHz local oscillator producing a sum frequency of 10.7 MHz. This IF signal is then amplified and passed to the limiter/discriminator where it is demodulated to reproduce the audio tone-burst. The tone decoder produces the output code corresponding to that at the input to the encoder. This code is then latched by the appropriate relay driver for twice the recycle time. The relay operates the hydraulic valve which controls the machine.

The encoding technique is particularly immune to noise and interference as a result of using a six-tone tone-burst. This sequence ensures high reliability because the tones must be received in the correct order, and must each be of sufficient duration for the tone-burst to be decoded as a valid code.

Sequential encoding with two tones has already proved reliable, as discussed in Chapter 5. The encoding and tone generation, as well as the tone decoding are all achieved with MOS/LSI (Metal Oxide Semi-conductor/ Large Scale Integration) integrated circuits designed specifically for the purpose. As discussed earlier, the initial problems with these decoders in a noisy environment were overcome partly by latching the decoded output for 2 transmissions rather than 1 (hence the selection of a recycle time of 150 ms giving 2 transmissions in 300 ms, and therefore a 300 ms response time).

The carrier oscillator and broadband power amplifier used in the monorail radio remote control system were used for this system as well.

To conserve battery power in the transmitter, CMOS (Complimentary Metal Oxide Semi-conductor) circuitry is used in the encoding section, and the power to the input stage of the broadband amplifier is switched on only during each tone burst, and hence the carrier is only transmitted during this period.

The recycle time depends on the desired response time of the controls. A slower response time allows longer periods between tone bursts, and thus consumes less battery power.

The encoding technique is particularly immune to noise and interference as a result of using a six-tone tone-burst. This sequence ensures high reliability because the tones must be received in the correct order, and must each be of sufficient duration for the tone-burst to be decoded as a valid code.

Sequential encoding with two tones has already proved reliable, as discussed in Chapter 5. The encoding and tone generation, as well as the tone decoding are all achieved with MOS LSI (Metal Oxide Semi-conductor/ Large Scale Integration) integrated circuits designed specifically for the purpose. As discussed earlier, the initial problems with these decoders in a noisy environment were overcome partly by latching the decoded output for 2 transmissions rather than 1 (hence the selection of a recycle time of 150 ms giving 2 transmissions in 300 ms, and therefore a 300 ms response time).

The carrier oscillator and broadband power amplifier used in the monorail radio remote control system were used for this system as well.

To conserve battery power in the transmitter, CMOS (Complimentary Metal Oxide Semi-conductor) circuitry is used in the encoding section, and the power to the input stage of the broadband amplifier is switched on only during each tone burst, and hence the carrier is only transmitted during this period.

The recycle time depends on the desired response time of the controls. A slower response time allows longer periods between tone bursts, and thus consumes less battery power.

The receiver circuitry, right to the output of the IF amplifier and limiter/discriminator is identical to that used for the monorail radio remote control system, except for the fact that the bandwidth is 30 KHz rather than 13 KHz.

The command latching and relay driving functions are implemented by quad integrated circuit timers connected as retriggerable monostables. A separate timer latches each command for twice the recycle time.

A switching power supply was used in the receiver for the same reasons as for the monorail radio remote control system.

6.4. Results Obtained in U.S.

The initial prototype system was tested in the laboratory, and also underground on the machine. Certain defects were found with the system, the principle one being the intermittent operation of the system in a noisy environment. This was due to the poor performance of the decoder circuits in this environment (as discussed earlier in this chapter).

After making the changes discussed earlier, the system was subjected to extensive testing in the laboratory up to a temperature of 50°C, and with simulated moist conditions (this was achieved by putting a kettle in the environmental chamber and warming it up every now and then). This was done as it was not known whether ingress of moisture had anything to do with the problem or not.

The system was then set up in a strike gully just off the slope (near the site where the Impact Ripper was in operation) and was run continuously for nine days.

During this time it performed very well. As a result of the successful tests in mining conditions, it was then decided to install the system on the impact ripper and use it on a permanent basis. It has been operating successfully ever since and a very positive response has been received from mining personnel who were initially very sceptical of the system. Two factors have been chiefly responsible for this success.

The first is the fact that prior to using radio remote control, the machine had been controlled with a cable controller for a long period of time. The change over to radio remote control thus emphasised the advantages mentioned earlier.

- 1) It has proved much more reliable than the cable controller (the chief problem with the cable controller was caused by damage to the cable).
- 2) It did not restrict the movement of the operator, but allowed him to position himself at the best vantage point.
- 3) It saved time wasted in threading the new cable round props, and thus improved productivity.

The second is the fact that it has been found very important to ensure reliable operation of the system under actual conditions before it is handed over to the mining personnel for continuous use on the machine.

CHAPTER 7

DISCUSSION AND CONCLUSION

This dissertation has concentrated on certain aspects related to the design of a number of prototype radio control systems. As is evident from the preceding chapters, there are many areas which could have been investigated in more detail, however the emphasis in this project has always been placed on providing successful and timely solutions to practical problems. These practical applications have provided a very good "test bed" for evaluating radio remote control techniques. Although the experimental mechanised mining stope at Doornfontein Gold Mine is a specialised stope, the same techniques and equipment could have widespread applicability in a normal mining environment. It has been the purpose of the project to provide techniques and prototype equipment. The next phase of the work will be involved with refining and expanding the techniques and equipment to provide commercially viable equipment which can be applied in a conventional mining environment.

7.1. Retrospective Review

It is worthwhile to take a retrospective view of the techniques and systems discussed here. This will help to highlight the salient points which have come to light during the preceding chapters.

In simple systems such as the two channel monorail system, there is no doubt that the simple two tone scheme of encoding provides probably the most elegant solution. It is designed around readily available components and the circuitry has proved very reliable and simple to

maintain. The phase locked loop tone decoders are very immune to noise and as mentioned earlier, they can even operate with a negative input SNR.

The choice of FM over SSB was based on the comparison given in Chapter 3. This choice has been borne out by work done at the Chamber of Mines Research Laboratories in comparing FM and SSB practically for voice communication. This work has shown that for $\beta = 1$, FM exhibited a noticeable improvement over SSB when the signal was strong whilst SSB showed no usable advantage over FM when the input signals are weak ^(P4).

In retrospect, the duplication of decoding circuitry and relays are not necessary as the decoders have proved that they are stable and free from spurious outputs.

The enclosures have proved very robust and have survived remarkably well, despite very rough handling. In the earliest prototype monorail systems the printed circuit boards were not coated and these boards have given problems as a result of components or tracks eventually corroding away. The switch assembly has proved extremely reliable in contrast with "mil-spec" switches which sometimes did not last more than a few days.

Very satisfactory results have been achieved with medium frequencies, however the only problem encountered was with the robustness of the loop antenna and the feeder cable connecting it to the portable transmitter. The alternative antenna discussed in Chapter 5 was a vast improvement and gave an MTBF of about 6 months (which was acceptable). It is evident that a built in antenna or a robust small helical antenna would be preferable. This is not possible at medium frequencies where the range must be more than 10 m to 20 m. For this reason, VHF and UHF propagation underground is being investigated.

From preliminary tests UHF propagation appears very promising, even over ranges of the order of 100 m and round bends.

Another aspect which was not given a lot of thought during the early stages of the project was self test features, and the provision of simple "go/no go" test equipment with radio remote control equipment. These two aspects are very important since it has been found that equipment is often reported as being faulty, when actually the fault lies elsewhere. This is time consuming and wasteful of manpower and should be avoided if possible. Another aspect which could receive more attention in the future is the choice of tone frequencies. This would become imperative if these systems were to be used on a large scale. This would necessitate careful selection of tone frequencies and sequences in order to minimise chances of intermodulation causing erroneous operation.

For the multichannel system many of the above comments are also applicable. UHF transmission is obviously very attractive for this application since the range is small. The rugged small "helical spring" antennas would definitely be an advantage particularly in place of the ferrite rod antenna since it is small and robust and would be less vulnerable.

The problem with the period averaging tone decoders has been discussed and the only comment to be made here is that a clear understanding and knowledge of the environment and conditions under which it will operate is imperative. Had this been done beforehand this problem may never have occurred.

Another point to always bear in mind is that complicating the design beyond that of your immediate requirements can pose problems since it is clear that the more complicated the system is, the more chance there is of something failing. The multi-channel system is a case in point. The requirement was for 13 channels not 64. The system could have therefore been designed to provide 16 channels. This would have enabled the tone encoding to have been reduced to 4 tones rather than 6, resulting in a definite reduction in the possibility of a failure to decode a valid tone sequence.

Ferrite rod antennas proved very satisfactory as receiving antennas, and worked well in close proximity to the steelwork of the machine.

Both systems provided adequate fail-safe operation. The modularity of the design has also enabled the same circuitry to be used for different applications.

7.2. Conclusion

It can be concluded that tone encoded remote control systems are very suitable for use underground. They have provided fail-safe, reliable operation over long periods of time (a number of years). Careful circuit analysis and design, together with thorough testing of the circuitry paid dividends. Attention must also be paid to mechanical details. The use of rugged, "hoseproof" enclosures proved worthwhile. It was found that the provision of reliable switches and rugged antennas was also important.

This work has shown the applicability and usefulness of radio remote control in a number of rather specialised applications. The equipment was well received by mining personnel who very quickly appreciated its advantages.

Although it was not possible to provide figures, everyone involved with the use of the radio remote control systems was unanimous in agreeing that production was definitely increased, whilst safety and working conditions were improved. The systems were definitely more reliable and easier to use than the cable systems they replaced. Maintenance problems were minimised by the fact that the system was modular - faulty boards could quickly be isolated and replaced with spare boards. Spare systems were kept underground and were used to replace faulty systems.

This project thus achieved the goal initially laid down - to prove that radio remote control could successfully be applied underground in gold mines, and therefore pave the way to widespread use of remote control in mining.

7.3. Suggestions for Future Work

Integrated circuits, specifically designed for use in remote control are now available. Although a number were available at the time when these projects were in the design stages, they were found unsuitable. However, some of the more recent ones may well be very suitable, and could reduce circuit complexity and cost if they were incorporated.

For the next generation multi-channel system it is recommended that a digital, microprocessor controlled design be utilised. A microprocessor controlled digital system would prove far more flexible and would also provide decision making capabilities which could prove very useful. This capability could have been put to good use in the multi-channel impact ripper system. The intermittent operation of the decoders in the presence of noise could very easily have been handled. Error checking and correction could have been incorporated or redundant transmissions

introduced. If one technique did not work, alternative approaches could have been tried. All these improvements to the system would be carried out by means of software updates. Where proportional control is required, this is far more easily incorporated into a digital system.

A radio remote control system based on the Intel 8748 "single chip computer" is being developed at present. The system will control a rock loader machine and provide proportional control. One of the reasons for choosing the 8748 is the possibility of future availability of low-power CMOS versions of this microprocessor or other members of the same family (e.g. romless 8035). The whole system has been designed with battery operation in mind, and low-power CMOS circuitry was therefore used wherever possible.

This project has shown that radio remote control can successfully be applied underground. The logical follow-up would be to conduct an exhaustive survey of possible applications of remote control underground, looking for those which would benefit from such a system. Those which would have widespread use should be singled out since these would then help to define more clearly the design approach to be adopted. At this point other aspects, such as cost effectiveness, would become important.

The large scale of mining activity in this country, not only in the gold industry, certainly warrants further work being carried out on this subject.

CHAPTER 8REFERENCES

1. Mann P.J. Portable Radio Remote Crane Control: Proven and Profitable. Material Handling Engineering, November 1968, pp. 80 - 87.
2. Bulk Cargo Handling: Radio Remote Controls Save \$ 500,000 a year. Material Handling Engineering, June 1969, pp. 126 - 128.
3. Digger/Derricks Get Remote Radio Control. Electrical World, November 1, 1974, pp. 60 - 61.
4. Radio Tone Signals Control Automated Yard. Modern Materials Handling, August 1970, pp. 38 - 41.
5. Hartley, D. Radio Remote Control Devices Cut Costs and Enhance the Safety of Railroads. Mining Engineering, June 1970, pp. 65 - 66.
6. Remote Switching Conquers Rugged Terrain. Electrical World, January 1973, p. 39.
7. Radio Operates Network Switches. Electrical World, August 15, 1973, pp. 54 - 55.
8. Yigdal, D.A. Capacitors Switched by Radio, Phone. Electrical World, June 1, 1971, pp. 76 - 77.
9. Morton, D. Radio Control Aids Load Management. Electrical World, April 15, 1971, p 58 - 60.

CHAPTER 8REFERENCES

1. Mann P.J. Portable Radio Remote Crane Control: Proven and Profitable. Material Handling Engineering, November 1968, pp. 80 - 87.
2. Bulk Cargo Handling: Radio Remote Controls Save \$ 500,000 a Year. Material Handling Engineering, June 1969, pp. 126 - 128.
3. Digger/Derricks Get Remote Radio Control. Electrical World, November 1, 1974, pp. 60 - 61.
4. Radio Tone Signals Control Automated Yard. Modern Materials Handling, August 1970, pp. 38 - 41.
5. Hartley, D. Radio Remote Control Devices Cut Costs and Enhance the Safety of Railroads. Mining Engineering, June 1970, pp. 65 - 66.
6. Remote Switching Conquers Rugged Terrain. Electrical World, January 1973, p. 39.
7. Radio Operates Network Switches. Electrical World, August 15, 1973, pp. 54 - 55.
8. Yigdal, D.A. Capacitors Switched by Radio, Phone. Electrical World, June 1, 1971, pp. 76 - 77.
9. Morton, D. Radio Control Aids Load Management. Electrical World, April 15, 1971, p 58 - 60.

10. Greene, T.E. The Rise of Remotely Manned Systems. Astronautics and Aeronautics, April 1972, pp 44-53.
11. Driverless Truck is Reliable Robot. Rock Products. April 1972, pp. 68 - 69.
12. Davis, H. Hand-Held Radio Transmitter Runs Continuous Miner. Coal Age, August 1977, pp. 68 - 69.
13. Cochrain, A.V. Semi-Remote Control Mining with Continuous Haulage. Mining Congress Journal, April 1974, pp. 34 - 41.
14. Warner, E.M. Cable and Wireless Remote Control of Continuous Miners. Mining Congress Journal, October 1974, pp. 34 - 39.
15. Lefevre, A. Remote Control of Mine Machinery. International Conference on Remote Control and Monitoring in Mining, United Kingdom, 1977, pp. 2.1. - 2.21.
16. Everell, M.D. and Tervo, R. Some Recent Applications of Radio Communication in Underground Mines. CIM Bulletin, April 1975, pp. 55 - 61.
17. Remote-Control System for Mine Locomotives. Electronics and Power, September 1971, p. 336.
18. Dobroski, H. Improved Rail Haulage Communications. The Fourth WVU Conference on Coal Mine Electrotechnology. August 2 - 4, 1978, pp. 29.1 - 29.14.
19. Dushac, H.M. Portable Remote Control of Trolley Circuit Breakers. The Fourth WVU Conference on Coal Mine Electrotechnology, August 2 - 4, 1978, pp. 30-1 - 30-11.
20. White, T.C. Comments on Paper by A. Lefevre (see ref. 15 above). International Conference on Remote Control and Monitoring in Mining, United Kingdom, 1977, pp. 7 - 9.

21. Lessmollman, W. and Harmann, W. Radio-Operated Remote Control Systems for Mines. Gluckauf and Translation 114 (1978), No. 10 pp 220 - 224.
22. Pickholtz, L. Basics: Remote Radio Controls Marine Engineering/Log, June 1969, pp 42 - 43.
23. Radio Control for Bucket Truck Previewed. Electrical World, July 1, 1972, pp 64 - 65.
24. Austin, B.A. Underground Radio Communication Techniques and Systems in South African Mines. Proceedings of a Workshop on Electromagnetic Guided Waves in Mine Environments. March 28 - 30, 1978, pp 87 - 102. Sponsored by USBM under contract no. HO 155 008.
25. Blitz, J. Ultrasonics: Methods and Applications, Butterworths, 1971.
26. Ultrasonics, Encyclopedia of Science and Technology, McGraw-Hill, 1971.
27. Infrared Radiation, Encyclopedia of Science and Technology, McGraw-Hill, 1971.
28. Taub, H. and Schilling, D.L. Principles of Communication Systems, McGraw-Hill, 1971.
29. Peebles, P.Z. Communication System Principles, Addison-Wesley, 1976.
30. Carlson, A.B. Communication Systems - An Introduction to Signals and Noise in Electrical Communication, McGraw-Hill 1975.
31. Robson, H.V. and van der Westhuizen, B.J.D. A Remote Radio Control System for Monorail Conveyors, Chamber of Mines Research Report No. 87/76.

32. Mines and Works Regulation 18.2
33. Bradley, J., Hopkins, M.J. and Robson, H.V.
An Experimental Underground Monorail System.
Proceedings of Electric Transport Symposium,
April 10 - 11, 1979, pp T 1 - T11.
34. Nelson, T.U. and Austin, B.A. A Comparison be-
tween Frequency Modulation and Single Sideband
Radio Communication Techniques for use in Mines,
Chamber of Mines Research Report No. 1/80.
35. Tong, D.A. Temperature Stabilization of Oscillators.
Wireless World, January 1972, pp 41-42.

APPENDIX 1DESIGN ANALYSIS OF TONE ENCODER AND DECODER CIRCUITSA1.1. Two Tone Sequential Encoder

Referring to figure A5.1. (see appendix 5) the two tone sequential tone encoder is made up of Q1, IC1, Q7, and Q8. Q1 oscillates triggering timer 1 in IC1 (556). This gives a high (V_{CC}) output switching on Q7 (TWIN-T oscillator 1). As the output of timer 1 goes low, it triggers timer 2 (via C4) thus switching on Q8 (TWIN-T oscillator 2). The two TWIN-T oscillators are thus sequenced with the tones, combined by C21/R40 and C22/R41. Channel 1 is selected when S1 is closed (R36 and R46 determine the two tones for this case). Channel 2 is selected when S2 is closed. (R37 and R47 determine the two tones for this case). The period of oscillator Q1 is set for the desired response time (i.e. 500 ms). The periods of timer 1 and timer 2 are each set at half the transmission time ($\frac{1}{2}$ of 158 ms). (N.B. the actual circuit diagram values give a transmission time of 200 ms, as used in the prototype system). Appendix 7 gives the data sheet of a 556 timer, from which the formula for the timeout can be obtained.

The frequency of oscillation of a TWIN-T network is given

by:-

$$f = \frac{1}{2\pi R_2 C_1} = \frac{1}{2\pi R_1 C_2}$$

where: $R_2 = 2R_1$

and $C_2 = 2C_1$

and the circuit is as shown in figure A1.1.

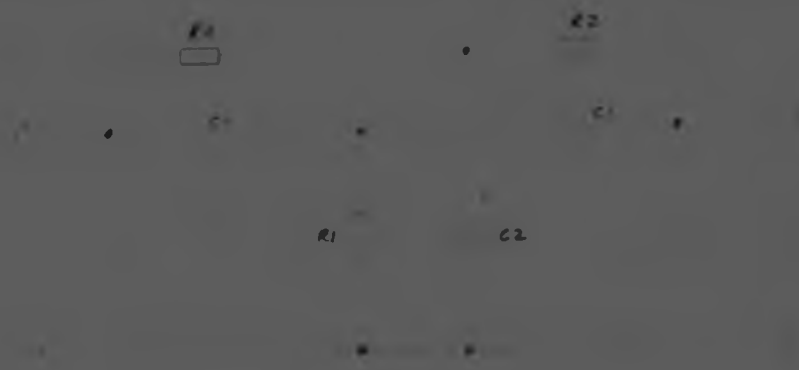

TWIN-T Network
Figure A1.1.

A1.2. Two Tone Sequential Decoder

With the addition of only one diode, two 567 tone decoders can be interconnected to provide sequential tone decoding. The circuit diagram is given with the data sheet for the XR-567 (AN-08 figure 1B - see later in this appendix). As mentioned, C3 of the tone 1 decoder is made large enough to delay turn-off of the tone 1 decoder to give the tone 2 decoder time to decode its tone.

To show the calculation procedure, circuit values are calculated below.

Assuming tone 1 = 3,15 KHz
and tone 2 = 4,05 KHz

the tone 1 decoder component values are obtained as follows (see data sheet later in this appendix).

$$t_D = \frac{1}{R_1 C_1}$$

where $C_1 = 0,247 \text{ F}$ (see figure A5.4)

and the circuit is as shown in figure A1.1.

TWIN-T Network
Figure A1.1.

A1.2. Two Tone Sequential Decoder

With the addition of only one diode, two 567 tone decoders can be interconnected to provide sequential tone decoding. The circuit diagram is given with the data sheet for the XR-567 (AN-08 figure 1B - see later in this appendix). As mentioned, C3 of the tone 1 decoder is made large enough to delay turn-off of the tone 1 decoder to give the tone 2 decoder time to decode its tone.

To show the calculation procedure, circuit values are calculated below.

Assuming tone 1 = 3,15 KHz
and tone 2 = 4,05 KHz

the tone 1 decoder component values are obtained as follows (see data sheet later in this appendix).

$$f_0 = \frac{1}{R_1 C_1}$$

where $C_1 = 0,247 \text{ } \mu\text{F}$ (see figure A5.4)

$$R_1 = \frac{1}{f_o C_1} = \frac{1}{(3,15 \times 10^3) (0,047 \times 10^{-6})}$$

$$= \underline{6,754 \text{ k } \Omega}$$

$$BW = 1070 \sqrt{\frac{V_i}{f_o C_2}}$$

where V_i = in signal amplitude (volts rms),

and C_2 = capacitance in μF

and BW = bandwidth of tone decoder (%)

Letting $C_2 = 1,5 \mu F$ (see figure A 5.4.)

$$BW = 1070 \sqrt{\frac{0,2}{(3,15 \times 10^3) (1,5)}} = \underline{6,96\%}$$

(as given in table
4.4.)

The recommended value for C_3 is $\geq 2C_2$ (for a normal single tone decoding), however in practice, since it is imperative to ensure that there are no false outputs, $C_3 \approx 3C_2$ was found to be satisfactory (experimentally). For the tone 1 decoder $C_3 \approx 4,5C_2$ was found suitable.

A1.3. Six Tone Sequential Encoding and Decoding

A pair of integrated circuits made by Consumer Micro-circuits (Fx 207 and FX 307) is ideally suited to tone encoding and decoding applications, particularly where faster response and more channels are required. As mentioned in chapter 3, these devices provide a 3-tone sequence (thus giving 8 channels). To obtain more channels, two devices were sequenced such that the two outputs combined provided a 6-tone sequence, thus giving 64 possible channels. The circuit for the six tone

sequential tone encoder is shown in figure A6.2. in appendix 6. IC2 provides the first group of 3 tones and IC3 the second group of 3 tones. As mentioned in chapter 6, the control switches are connected to points within an 8 x 8 matrix. IC2 transmits the 3 bit "row address" whilst IC3 transmits the 3 bit "column address". The transmit enable (TXENBL) input initiates the transmission of the 6 tone sequence when a pushbutton is being pressed.

Once all the component values for the FX207 encoders can be calculated, the overall timing related to the 6 tone sequence must be determined. Considering one FX 207, the timing requirements are as shown in figure A1.2.

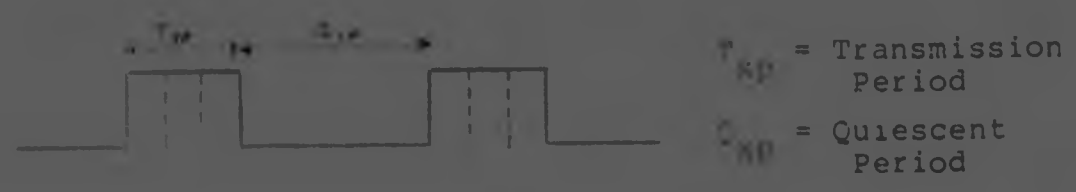

FX 207 timing requirements
Figure A1.2.

have

$$T_{xp} = 3T_p \dots\dots (1)$$

where T_p is transmission tone period

the FX 307 to clear down after reception of a valid tone sequence.

$$Q_{xp} \geq 1,5 G_p \dots\dots (2)$$

where $G_p = 2T_p \dots\dots (3)$

Substituting (3) in (2)

$$Q_{xp} \geq 3T_p$$

This is the requirement for one FX207, however the system utilises two FX 207 integrated circuits sequenced to give a 6 tone sequence. Since the second 3 tone group code utilises different frequencies (and therefore a different receiver) to the first 3 tone group code, the quiescent period after the first 3 tone group code can overlap with the transmission of the second group code.

Now since

$$T_{xp} = 3 T_p = Q_{xp}$$

Thus, even if there was no quiescent period, the transmission of the second 3 tone group code gives the first 3 tone group code receiver time to clear down (and vice versa).

Since simultaneous transmission of different group codes is to be avoided, we must allow some small quiescent period Q_{xp1} between the two 3 tone group codes and Q_{xp2} after the second 3 tone group code. The timing for the overall 6 tone sequence is therefore as shown in figure A1.3.

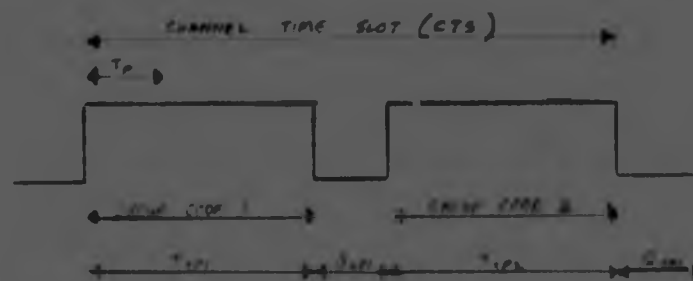

6 Tone Sequence Timing

Figure A1.3.

The major source of error is the production error on the tolerance of the constant for T_p (i.e. 0,63). This can fall in the range 0,6 to 0,7. We are interested in errors where T_p is longer, therefore:-

$$\begin{aligned} \% \text{ error in } T_P &= \frac{0,7 - 0,63}{0,63} \times 100 \\ &= \underline{11,1\%} \end{aligned}$$

$$\text{Now } T_{xp} = 3T_P$$

$$\% \text{ error in } T_{xp} = 3 \times 11,11 = \underline{33,3\%}$$

$$Q_{xp1} = \frac{1}{3} T_{xp1} = T_{p1}$$

$$\text{and } Q_{xp2} = \frac{1}{3} T_{xp2} = T_{p2}$$

(N.B. Since 2% resistors and capacitors are to be used their contribution to the error is small in comparison with the above error).

Therefore the total channel time slot is:-

$$CTS = 4T_{p1} + 4T_{p2}$$

The minimum value for the coefficient (i.e. 0,6) could only have an effect on the number of cycles (per tone) transmitted, however this will be compensated for by transmitting extra cycles over and above the required 10 cycles.

First, non-harmonically related tone frequencies must be chosen. The recommended bandwidth of 8% will be used. A maximum frequency of 6 KHz will be used (actual max. limit is 7 KHz). The tone frequencies, together with component values as shown in table A1.1.

	f (KHz)	BW (Hz)	f _{CH} (KHz)	f _{CL} (KHz)	R (K)	C ₁ or C ₂ (pF)
Group Code 1	5,952	476	6190	5714	120k + 0k	1000
	5,494	440	5714	5274	120k + 10k	1000
	5,030	402	5231	4829	120k + 22k	1000
Group Code 2	4,591	367	4774	4407	150k + 5k6	1000
	4,153	332	4319	3987	150k + 22k	1000
	3,779	302	3930	3628	150k + 39k	1000

Tone Frequencies and
Related Components

Table A1.1.

Thus we have the following minimum frequencies (f_{\min})

$$\text{group code 1 } f_{\min} = \underline{5,030 \text{ KHz}}$$

$$\text{group code 2 } f_{\min} = \underline{3,779 \text{ KHz}}$$

In order to allow for impulsive noise interference and also component tolerances, 20 cycles of each tone will be transmitted.

$$T_p = \frac{20}{f_{\min}}$$

$$4T_{p1} = 4 \times \left(\frac{20}{5,030 \times 10^3} \right) = \underline{15,9 \text{ ms}}$$

$$\text{and } 4T_{p2} = 4 \times \left(\frac{20}{3,779 \times 10^3} \right) = \underline{21,2 \text{ ms}}$$

$$\text{CTS} = 4T_{p1} + 4T_{p2} = 15,9 + 21,2 = \underline{37,1 \text{ ms}}$$

Referring to the keyboard encoder module (figure A6.1.) one half of IC10 provides a TXGAT (transmit gate) output which "gates" the transmitter power amplifier on when it is required to transmit a code. This TXGAT output is therefore equal to CTS

$$\text{TXGAT} = \text{CTS}$$

Now $T = 1,1 RC$ (for the 556 - see data in appendix 7)

$$\text{Letting } C = 0,15 \mu\text{F}$$

$$R = \frac{T}{1,1C} = \frac{37,1 \times 10^{-3}}{1,1 \times 0,15 \times 10^{-6}}$$

$$= 224,8 \text{ k}\Omega$$

$$\text{use } R = 220 \text{ k}\Omega$$

Since the first FX 207 must still have a transmission delay set (i.e. T_d) $700 \mu\text{s}$ is arbitrarily chosen (10 times the minimum).

$$\text{Since } T_d = 0,7R_d C_d$$

$$\text{and we let } R_{d1} = 100 \text{ k}$$

$$C_{d1} = 0,01 \mu\text{F}$$

$$T_d = 0,7 (100 \times 10^3) (0,01 \times 10^{-6})$$

$$= 700 \mu\text{s}$$

The second group code is delayed by

$$T_{d2} = 4T_{p1} + T_{d1} = 15,9 + 0,7 = 16,6 \text{ ms}$$

$$\text{Trying } C_{d2} = 0,15 \mu\text{F}$$

$$R_{d2} = \frac{T_{d2}}{0,7C_{d2}} = \frac{16,6 \times 10^{-3}}{0,7 (0,15 \times 10^{-6})}$$

$$= 158 \text{ k}\Omega$$

$$\text{use } R_{d2} = 150\text{k} + 8 \text{ k}\Omega$$

The tone periods are

$$T_{p1} = \frac{20}{5,030 \times 10^3} = 3,98 \text{ ms}$$

$$T_{p2} = \frac{20}{3,779 \times 10^3} = 5,29 \text{ ms}$$

$$\text{Trying } C_{t1} = 0,033 \mu\text{F}$$

$$R_{t1} = \frac{T_{p1}}{0,63 C_{t1}} = \frac{3,98}{0,63 \times 0,033 \times 10^{-6}}$$

$$= 191,4 \times 10^3$$

$$\text{use } R_{t1} = \underline{180 \text{ k} + 12 \text{ k}}$$

$$\text{Trying } C_{t2} = 0,033 \mu\text{F}$$

$$R_{t2} = \frac{T_{p2}}{0,63 C_{t2}} = \frac{5,29 \times 10^{-3}}{0,63 \times 0,033 \times 10^{-6}}$$

$$= 254,4 \times 10^3$$

$$\text{use } R_{t2} = \underline{220 \text{ k} + 33 \text{ k}}$$

The receiver gate period must be $2T_p$

$$\text{Try } C_{s1} = 0,068 \mu\text{F}$$

$$R_{s1} = \frac{2T_{p1}}{0,63 C_{s1}} = \frac{2 (3,98 \times 10^{-3})}{0,63 \times 0,068 \times 10^{-6}}$$

$$= 185,8 \times 10^3$$

$$\text{use } R_{s1} = \underline{180 \text{ k} + 6 \text{ k}8}$$

$$\text{and Try } C_{s2} = 0,068 \mu\text{F}$$

$$R_{s2} = \frac{2T_{p2}}{0,63 C_{s2}} = \frac{2 (5,29 \times 10^{-3})}{0,63 \times 0,068 \times 10^{-6}}$$

$$= 247,0 \times 10^3$$

$$\text{use } R_{s2} = \underline{220 \text{ k} + 27 \text{ k}}$$

The group code 2 receiver (see fig A6.7) output is gated externally to ensure that the second set of 3 times follows immediately on from the first group. This gate period must be at least $4T_p$ (i.e. 21,2 ms)

$$\text{let } GP_{\text{EXT}} = 25 \text{ ms}$$

$$\text{Trying } C_{t1} = \underline{0,033 \mu F}$$

$$R_{t1} = \frac{T_{p1}}{0,63 C_{t1}} = \frac{3,98}{0,63 \times 0,033 \times 10^{-6}}$$

$$= 191,4 \times 10^3$$

$$\text{use } R_{t1} = \underline{180 \text{ k} + 12 \text{ k}}$$

$$\text{Trying } C_{t2} = \underline{0,033 \mu F}$$

$$R_{t2} = \frac{T_{p2}}{0,63 C_{t2}} = \frac{5,29 \times 10^{-3}}{0,63 \times 0,033 \times 10^{-6}}$$

$$= 254,4 \times 10^3$$

$$\text{use } R_{t2} = \underline{220 \text{ k} + 33 \text{ k}}$$

The receiver gate period must be $2T_p$

$$\text{Try } C_{s1} = \underline{0,068 \mu F}$$

$$R_{s1} = \frac{2T_{p1}}{0,63 C_{s1}} = \frac{2 (3,98 \times 10^{-3})}{0,63 \times 0,068 \times 10^{-6}}$$

$$= 185,8 \times 10^3$$

$$\text{use } R_{s1} = \underline{180 \text{ k} + 6 \text{ k}\Omega}$$

$$\text{and Try } C_{s2} = \underline{0,068 \mu F}$$

$$R_{s2} = \frac{2T_{p2}}{0,63 C_{s2}} = \frac{2 (5,29 \times 10^{-3})}{0,63 \times 0,068 \times 10^{-6}}$$

$$= 247,0 \times 10^3$$

$$\text{use } R_{s2} = \underline{220 \text{ k} + 27 \text{ k}}$$

The group code 2 receiver (see fig A6.7) output is gated externally to ensure that the second set of 3 times follows immediately on from the first group. This gate period must be at least $4T_{p2}$ (i.e. 21,2 ms)

$$\text{let } GP_{EXT} = 25 \text{ ms}$$

$$\text{Trying } C = 0,15 \mu F$$

$$R = \frac{25 \times 10^{-3}}{1,1 \times 0,15 \times 10^{-6}} \\ = 151,5 \times 10^3$$

$$\text{use } R = \underline{150 \text{ k}}$$

As mentioned earlier, to ensure jitter free control (i.e. no momentary loss of an output due to noise) two transmissions will be sent within the response time of 300 ms. This ensures that a channel only de-activates when 2 consecutive transmissions are lost.

This time in the transmitter is called the recycle time. It is set at 150 ms.

$$\text{Trying } C_R = \underline{0,47 \mu F}$$

$$R_D = \frac{T_R}{1,1 C_R} = \frac{150 \times 10^{-3}}{1,1 \times 0,47 \times 10^{-6}} \\ = \underline{290 \text{ k}}$$

$$\text{use } R = 270 \text{ k} + 18 \text{ k}$$

Coupled with this, the decoder must be set at 300 ms.

This analysis has outlined all major calculations involved in designing the multi-channel Impact Ripper System tone encoders and decoders.

---o0o---

XR-567

Monolithic Tone Decoder

The XR-567 is a monolithic phase-locked loop system designed for general purpose tone and frequency decoding. The circuit operates over a wide frequency band of 0.01 Hz to 500 kHz and contains a logic compatible output which can sink up to 100 milliamps of load current. The bandwidth, center frequency, and output delay are independently determined by the selection of four external components.

Figure 1 contains a functional block diagram of the complete monolithic system. The circuit consists of a phase detector, low-pass filter, and current-controlled oscillator which comprise the basic phase-locked loop, plus an additional low-pass filter and quadrature detector that enable the system to distinguish between the presence or absence of an input signal at the center frequency.

FEATURES

- Bandwidth adjustable from 0 to 14 MHz
- Logic compatible output with 100 mA current sinking capability
- Highly stable center frequency
- Center frequency adjustable from 0.01 Hz to 500 kHz
- Inherent immunity to false signals
- High rejection of out-of-band signals and noise
- Frequency range adjustable over 20:1 range by external resistor

APPLICATIONS

- Touch-Tone® Decoding
- Sequential Tone Decoding
- Communications Paging
- Ultrasonic Remote Control and Monitoring

ABSOLUTE MAXIMUM RATINGS

Power Supply	10 volts
Power Dissipation (package limitation)	
Ceramic package	385 mW
Derate above +25°C	5.0 mW/°C
Temperature	
Operating	
XR-567N	-55°C to +125°C
XR-567CN/567CP	0°C to +70°C
Storage	-65°C to +150°C

AVAILABLE TYPES

Part Number	Package	Operating Temperature
XR-567M	Ceramic	-55°C to +125°C
XR-567CN	Ceramic	0°C to +75°C
XR-567CP	Plastic	0°C to +75°C

EQUIVALENT SCHEMATIC DIAGRAM

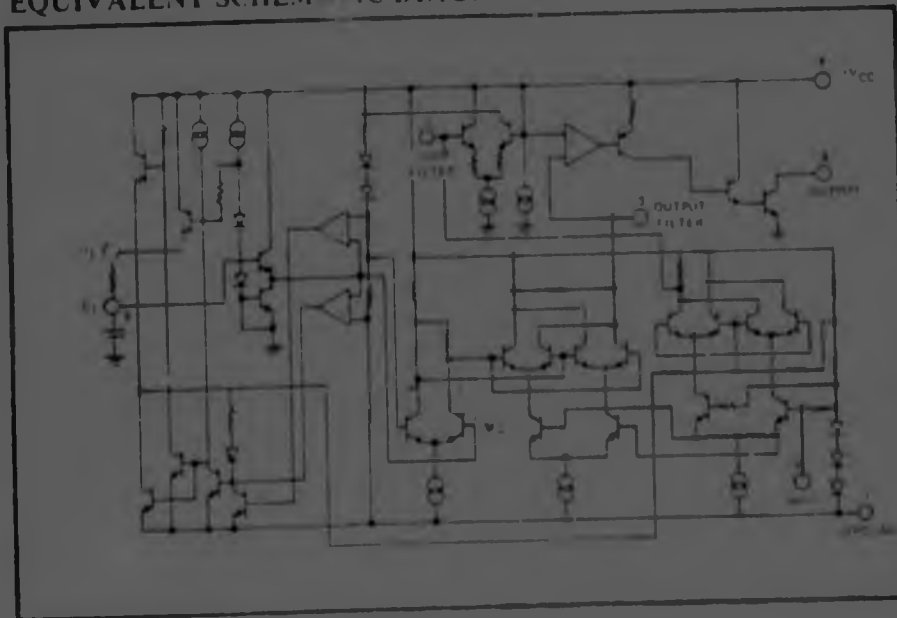

FUNCTIONAL BLOCK DIAGRAM

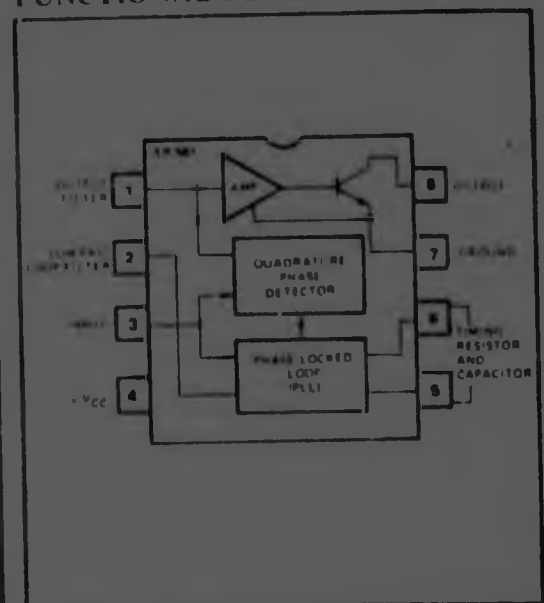

Figure 1 Functional Block Diagram

XR-567

Monolithic Tone Decoder

The XR-567 is a monolithic phase-locked loop system designed for general purpose tone and frequency decoding. The circuit operates over a wide frequency band of 0.01 Hz to 500 kHz and contains a logic compatible output which can sink up to 100 milliamps of load current. The bandwidth, center frequency, and output delay are independently determined by the selection of four external components.

Figure 1 contains a functional block diagram of the complete monolithic system. The circuit consists of a phase detector, low-pass filter, and current-controlled oscillator which comprise the basic phase-locked loop, plus an additional low-pass filter and quadrature phase detector that enable the system to distinguish between the presence or absence of an input signal at the center frequency.

FEATURES

- Bandwidth adjustable from 0 to 14
- Logic compatible output with 100 mA current sinking capability
- Highly stable center frequency
- Center frequency adjustable from 0.01 Hz to 500 kHz
- Inherent immunity to false signals
- High rejection of out-of band signals and noise
- Frequency range adjustable over 20:1 range by external resistor

APPLICATIONS

- Touch-Tone® Decoding
- Sequential Tone Decoding
- Communications Paging
- Ultrasonic Remote-Control and Monitoring

ABSOLUTE MAXIMUM RATINGS

Power Supply	10 volts
Power Dissipation (package limitation)	385 mW
Ceramic package	50 mW/°C
Derate above +25°C	
Temperature	
Operating	
XR-567M	-55°C to +125°C
XR-567CN/567CP	0°C to +70°C
Storage	-65°C to +150°C

AVAILABLE TYPES

Part Number	Package	Operating Temperature
XR-567M	Ceramic	-55°C to +125°C
XR-567CN	Ceramic	0°C to +75°C
XR-567CP	Plastic	0°C to +75°C

EQUIVALENT SCHEMATIC DIAGRAM

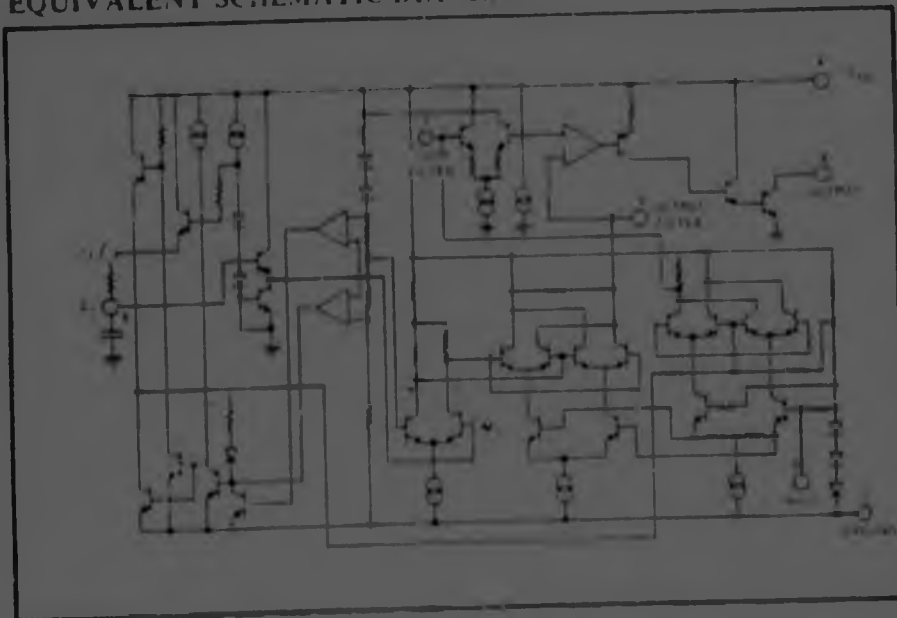

FUNCTIONAL BLOCK DIAGRAM

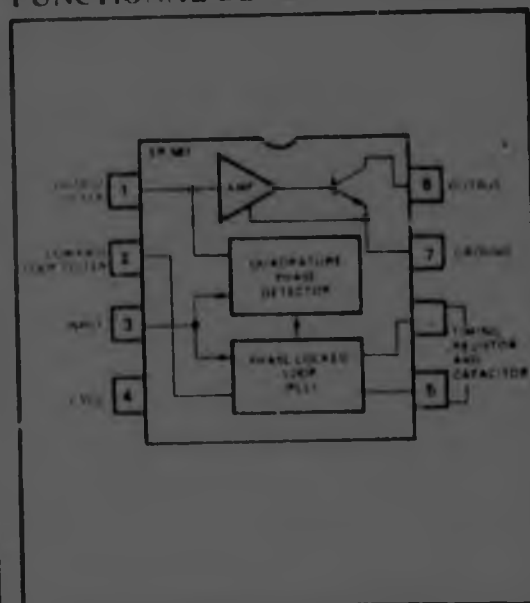

Figure 1 Functional Block Diagram

Test Conditions: $V_{CC} = +5V$, $T_A = 25^\circ C$, unless otherwise specified. Test circuit of Figure 2.

CHARACTERISTICS	LIMITS			UNITS	CONDITIONS
	MIN	TYP	MAX		
GENERAL					
Supply Voltage Range	4.75		9.0	V dc	
Supply Current				mA	$R_L = 20\text{ k}\Omega$
Quiescent XR-567		6	8	mA	$R_L = 20\text{ k}\Omega$
XR-567C		7	10	mA	$R_L = 20\text{ k}\Omega$
Activated XR-567		11	13	mA	$R_L = 20\text{ k}\Omega$
XR-567C		12	15	mA	$R_L = 20\text{ k}\Omega$
Output Voltage			15	V	
Negative Voltage at Input			-10	V	
Positive Voltage at Input			$V_{CC} + 0.5$	V	
CENTER FREQUENCY					
Highest Center Frequency	100	500		kHz	
Center Frequency Stability				ppm/ $^\circ C$	See Figure 9
Temperature $T_A = 25^\circ C$		35		ppm/ $^\circ C$	See Figure 9
$0 < T_A < 70^\circ C$		± 60		ppm/ $^\circ C$	See Figure 9
$-55 < T_A < +125^\circ C$		± 140			
Supply Voltage				%/V	$f_0 = 100\text{ kHz}$
XR-567		0.5	1.0	%/V	$f_0 = 100\text{ kHz}$
XR-567C		0.7	2.0		
DETECTION BANDWIDTH					
Largest Detection Bandwidth				% of f_0	$f_0 = 100\text{ kHz}$
XR-567	12	14	16	% of f_0	$f_0 = 100\text{ kHz}$
XR-567C	10	14	18		
Largest Detection Bandwidth Skew				% of f_0	
XR-567		1	2	% of f_0	
XR-567C		1	3		
Largest Detection Bandwidth Variation				%/ $^\circ C$	$V_{in} = 300\text{ mV rms}$
Temperature		± 0.1		%/V	$V_{in} = 300\text{ mV rms}$
Supply Voltage		± 2			
INPUT					
Input Resistance		20		$\text{k}\Omega$	
Smallest Detectable Input Voltage		20	25	mV rms	$I_L = 100\text{ mA}$, $I_1 = f_0$
Largest No-Output Input Voltage	10	15		mV rms	$I_L = 100\text{ mA}$, $I_1 = f_0$
Greatest Simultaneous Outband Signal to Inband Signal Ratio		+6		dB	
Minimum Input Signal to Wideband Noise Ratio		-6		dB	$B_n = 140\text{ kHz}$
OUTPUT					
Output Saturation Voltage		0.2	0.4	V	$I_L = 10\text{ mA}$, $V_{in} = 25\text{ mV rms}$
		0.6	1.0	V	$I_L = 100\text{ mA}$, $V_{in} = 25\text{ mV rms}$
Output Leakage Current		0.01	25	μA	
Fastest ON-OFF Cycling Rate		$f_0/20$			
Output Rise Time		150		ns	$R_L = 50\Omega$
Output Fall Time		30		ns	$R_L = 50\Omega$

DEFINITION OF XR-567 PARAMETERS

CENTER FREQUENCY f_0

f_0 is the free-running frequency of the current-controlled oscillator with no input signal. It is determined by resistor R_1 between pins 5 and 6, and capacitor C_1 from pin 6 to ground. f_0 can be approximated by

$$f_0 \approx \frac{1}{R_1 C_1}$$

where R_1 is in ohms and C_1 is in farads

DETECTION BANDWIDTH (BW)

The *detection bandwidth* is the frequency range centered about f_0 , within which an input signal larger than the threshold voltage (typically 20 mV rms) will cause a logic zero state at the output. The detection bandwidth corresponds to the capture range of the PLL and is determined by the low-pass bandwidth filter. The bandwidth of the filter, as a percent of f_0 , can be determined by the approximation

$$BW = 1976 \sqrt{\frac{V_i}{10^3 C_2}}$$

where V_i is the input signal in volts, rms, and C_2 is the capacitance at pin 2 in μF

LARGEST DETECTION BANDWIDTH

The *largest detection bandwidth* is the largest frequency range within which an input signal above the threshold voltage will cause a logical zero state at the output. The maximum detection bandwidth corresponds to the lock range of the PLL.

DETECTION BAND SKEW

The *detection band skew* is a measure of how accurately the largest detection band is centered about the center frequency, f_0 . It is defined as $(f_{\text{max}} + f_{\text{min}} - 2f_0)/f_0$, where f_{max} and f_{min} are the frequencies corresponding to the edges of the detection band. If necessary, the detection band skew can be reduced to zero by an optional centering adjustment (See Optional Controls).

DESCRIPTION OF CIRCUIT CONTROLS

OUTPUT FILTER - C_3 (Pin 1)

Capacitor C_3 connected from pin 1 to ground forms a simple low-pass *post detection* filter to eliminate spurious outputs due to out-of-band signals. The time constant of the filter can be expressed as $T_3 = R_3 C_3$, where R_3 (4.7 $k\Omega$) is the internal impedance at pin 1.

The precise value of C_3 is not critical for most applications. To eliminate the possibility of false triggering by spurious signals, it is recommended that C_3 be $\geq 2C_2$, where C_2 is the loop filter capacitance at pin 2.

If the value of C_3 becomes too large, the *turn-on or turn-off* time of the output stage will be delayed until the voltage change across C_3 reaches the threshold voltage. In certain applications, the delay may be desirable as a means of suppressing spurious outputs. Conversely, if the value of C_3 is too small, the beat rate at the output of the quadrature detector (see Figure 1) may cause a false logic level change at the output (Pin 8).

The average voltage (during lock) at pin 1 is a function of the inband input amplitude in accordance with the given transfer characteristic.

LOOP FILTER - C_2 (Pin 2)

Capacitor C_2 connected from pin 2 to ground serves as a single pole, low-pass filter for the PLL portion of the XR-567. The filter time constant is given by $T_2 = R_2 C_2$, where R_2 (10 $k\Omega$) is the impedance at pin 2.

The selection of C_2 is determined by the detection bandwidth requirements, as shown in Figure 6. For additional information see section on "Definition of XR-567 Parameters".

The voltage at pin 2, the phase detector output, is a linear function of frequency over the range of 0.95 to 1.05 f_0 , with a slope of approximately 20 mV/% frequency deviation.

INPUT (Pin 3)

The input signal is applied to pin 3 through a coupling capacitor. This terminal is internally biased at a dc level 2 volts above ground, and has an input impedance level of approximately 20 $k\Omega$.

TIMING RESISTOR R_1 AND CAPACITOR C_1 (Pins 5 and 6)

The center frequency of the decoder is set by resistor R_1 between pins 5 and 6, and capacitor C_1 from pin 6 to ground, as shown in Figure 3.

Pin 5 is the oscillator squarewave output which has a magnitude of approximately $V_{CC} - 1.4\text{V}$ and an average dc level of $V_{CC}/2$. A 1 $k\Omega$ load may be driven from this point. The voltage at pin 6 is an exponential triangle waveform with a peak-to-peak amplitude of 1 volt and an average dc level of $V_{CC}/2$. Only high impedance loads should be connected to pin 6 to avoid disturbing the temperature stability or duty cycle of the oscillator.

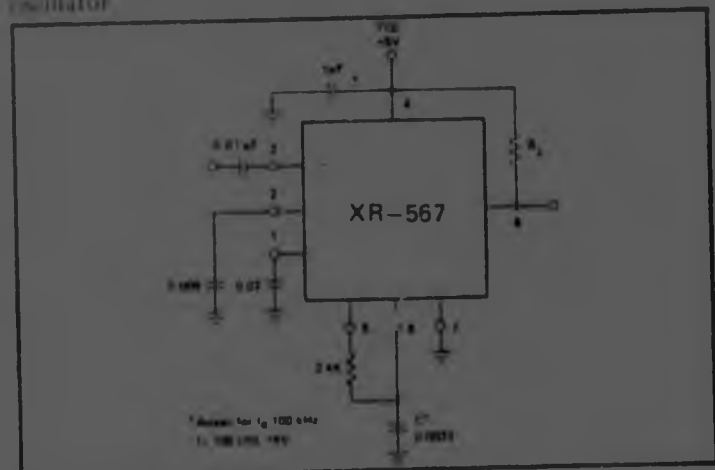

Figure 2 XR-567 Test Circuit

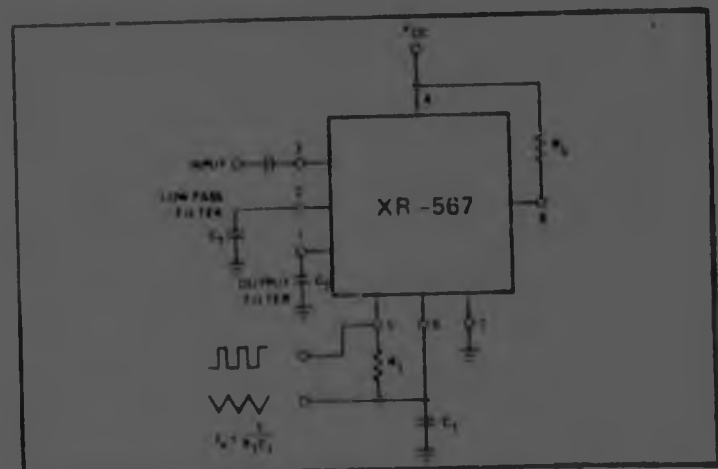

Figure 3 XR-567 Connection Diagram

TYPICAL CHARACTERISTIC CURVES

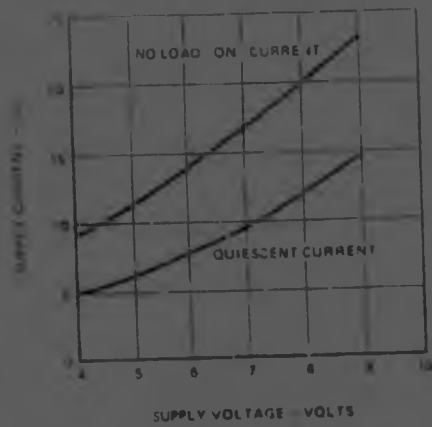

Figure 4. Supply Current Versus Supply Voltage

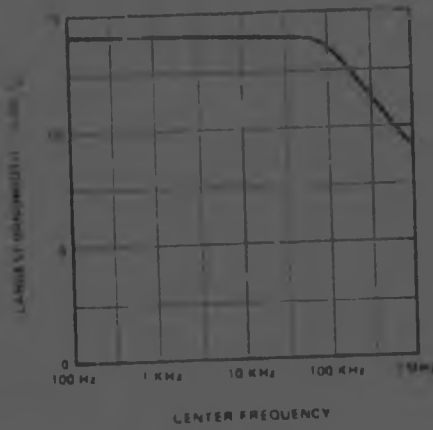

Figure 5. Largest Detection Bandwidth Versus Operating Frequency

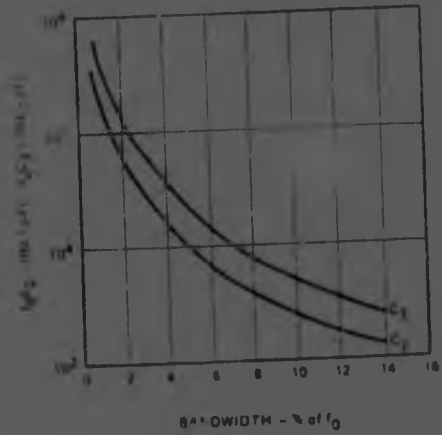

Figure 6. Detection Bandwidth as a Function of C_2 and C_3

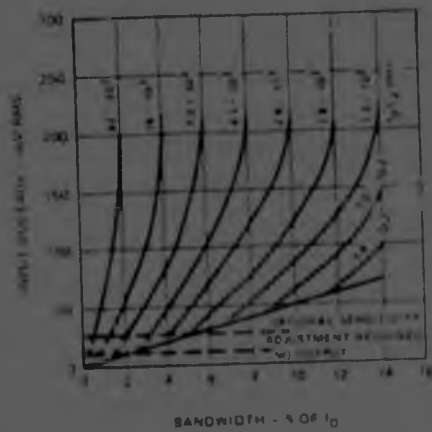

Figure 7. Bandwidth Versus Input Signal Amplitude

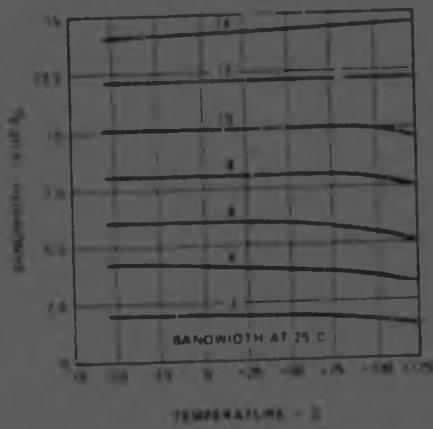

Figure 8. Bandwidth Variation With Temperature

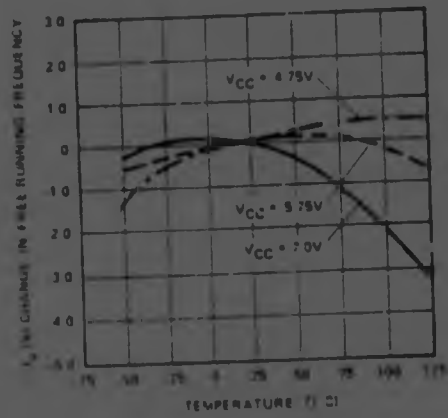

Figure 9. Frequency Drift With Temperature

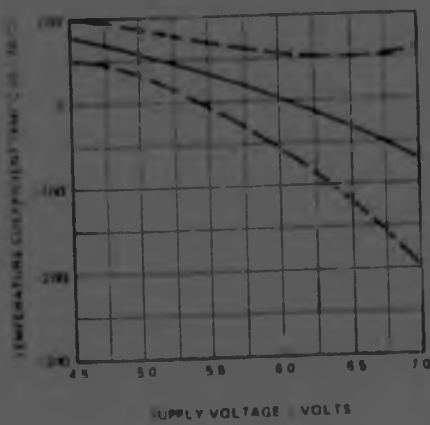

Figure 10. Temperature Coefficient of Center Frequency (Mean and S D)

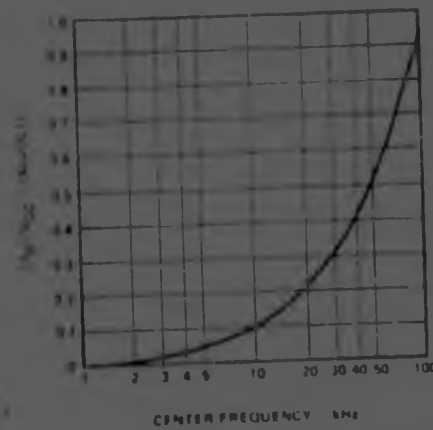

Figure 11. Power Supply Dependence of Center Frequency

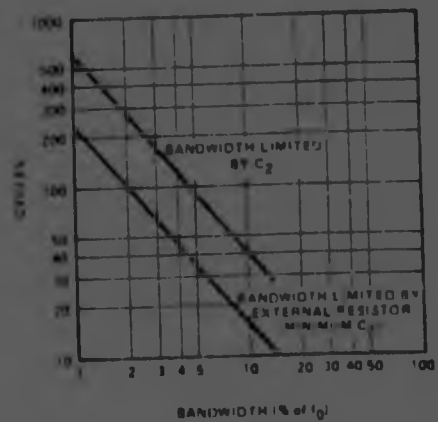

Figure 12. Greatest Number of Cycles Before Output

LOGIC OUTPUT (Pin 8)

Terminal 8 provides a binary logic output when an input signal is present within the pass band of the decoder. The logic output is an uncommitted, "bare-collector" power transistor capable of switching high current loads. The current level at the output is determined by an external load resistor, R_L , connected from pin 8 to the positive supply.

When an in-band signal is present, the output transistor at pin 8 saturates with a collector voltage less than 1 volt (typically 0.5V) at full rated current of 100 mA. If large output voltage swings are needed, R_L can be connected to a supply voltage V_+ higher than the V_{CC} supply. For safe operation, $V_+ \leq 20$ volts.

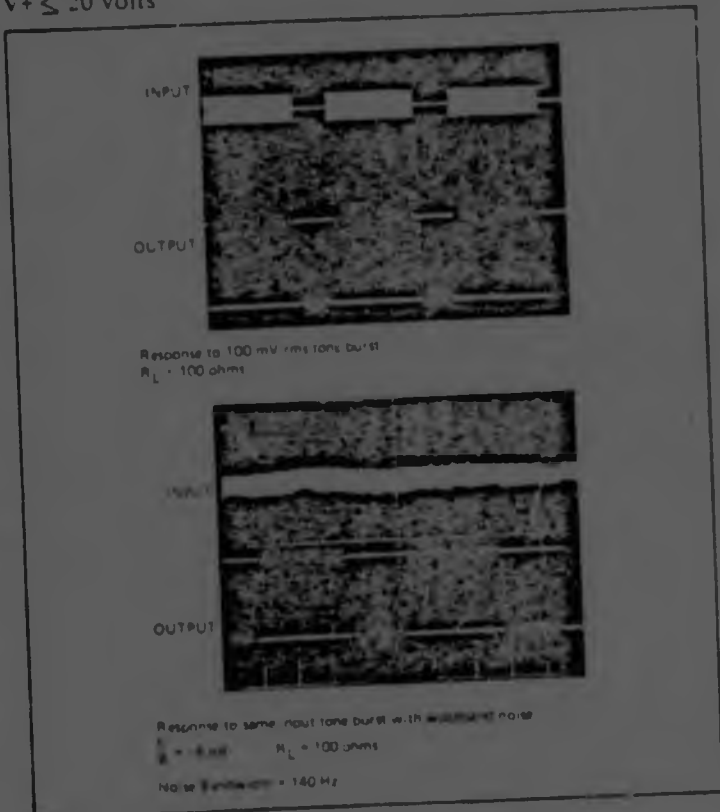

Figure 13 Typical Response

OPERATING INSTRUCTIONS

SELECTION OF EXTERNAL COMPONENTS

A typical connection diagram for the XR-567 is shown in Figure 3. For most applications, the following procedure will be sufficient for determination of the external components R_1 , C_1 , C_2 , and C_3 .

1. R_1 and C_1 should be selected for the desired center frequency by the expression $f_0 \approx 1/R_1C_1$. For optimum temperature stability, R_1 should be selected such that $2k\Omega \leq R_1 \leq 20k\Omega$, and the R_1C_1 product should have sufficient stability over the projected operating temperature range.
2. Low-pass capacitor, C_2 , can be determined from the Bandwidth versus Input Signal Amplitude graph of Figure 7. One approach is to select an area of operation from the graph, and then adjust the input level and value of C_2 accordingly. Or, if the input amplitude variation is known, the required f_0C_2 product can be found to give the desired bandwidth. Constant bandwidth operation requires $V_i > 200$ mV rms. Then, as noted on the graph, bandwidth will be controlled solely by the f_0C_2 product.
3. Capacitor C_3 sets the limit edge of the low-pass filter which attenuates frequencies outside of the detection band and

thereby minimizing spurious outputs. If C_3 is too small, the frequencies adjacent to the detection band may cause the output stage off and on at the beat frequency; or the output may pulse off and on during the turn-on transient. A typical minimum value for C_3 is $2C_2$.

Conversely, if C_3 is too large, turn-on and turn-off of the output stage will be delayed until the voltage across C_3 passes the threshold value.

PRINCIPLE OF OPERATION

The XR-567 is a frequency selective tone decoder system based on the phase-locked loop (PLL) principle. The system is comprised of a phase-locked loop, a quadrature AM detector, a voltage comparator, and an output logic driver. The four sections are internally interconnected as shown in Figure 1.

When an input tone is present within the pass-band of the circuit, the PLL synchronizes or "locks" on the input signal. The quadrature detector serves as a lock indicator. When the PLL is locked on an input signal, the dc voltage at the output of the detector is shifted. This dc level shift is then converted to an output logic pulse by the amplifier and logic driver. The logic driver is a "bare collector" transistor stage capable of switching 100 mA loads.

The logic output at pin 8 is normally in a "high" state, and a tone that is within the capture range of the decoder is present at the input. When the decoder is locked on an input signal, the logic output at pin 8 goes to a "low" state.

The center frequency of the detector is set by the free-running frequency of the current-controlled oscillator in the PLL. This free-running frequency, f_0 , is determined by the selection of R_1 and C_1 connected to pins 5 and 6, as shown in Figure 3. The detection bandwidth is determined by the size of the PLL filter capacitor, C_2 , and the output response speed is controlled by the output filter capacitor, C_3 .

OPTIONAL CONTROLS PROGRAMMING

Varying the value of resistor R_1 and/or capacitor C_1 will change the center frequency. The value of R_1 can be changed either mechanically or by solid state switches. Additional C_1 capacitors can be added by grounding them through saturated npn transistors.

SPEED OF RESPONSE

The minimum lock-up time is inversely related to the loop frequency. As the natural loop frequency is lowered, the turn-on transient becomes greater. Thus maximum operating speed is obtained when the value of capacitor C_2 is minimum. At the instant an input signal is applied its phase may drive the oscillator away from the incoming frequency rather than toward it. Under this condition, the lock-up transient is in a worst case situation, and the minimum theoretical lock-up time will not be achievable.

The following expressions yield the values of C_2 and C_3 in microfarads, which allow the maximum operating speeds for various center frequencies. The minimum rate that digital information may be detected without losing information due to turn-on transient or output chatter is about 10 cycles/bit, which corresponds to an information transfer rate of $f_0/10$ baud.

$$C_2 = \frac{130}{f_0}, \quad C_3 = \frac{260}{f_0}$$

In situations where minimum turn-off time is of less importance than fast turn-on, the optional sensitivity adjustment circuit of Figure 14 can be used to bring the quiescent C_3 voltage closer to the threshold voltage. Sensitivity to beat frequencies, noise, and extraneous signals, however, will be increased.

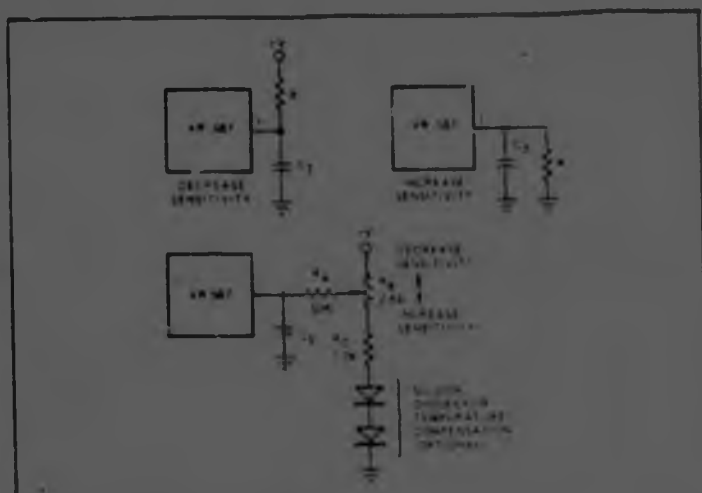

Figure 14. Optional Sensitivity Connections

CHATTER

When the value of C_3 is small, the lock transient and ac components at the lock detector output may cause the output stage to move through its threshold more than once, resulting in output chatter.

Although some loads, such as lamps and relays will not respond to chatter, logic may interpret chatter as a series of output signals. Chatter can be eliminated by feeding a portion of the output back to the input (pin 1) or, by increasing the size of capacitor C_3 . Generally, the feedback method is preferred since keeping C_3 small will enable faster operation. Three alternate schemes for chatter prevention are shown in Figure 15. Generally, it is only necessary to assure that the feedback time constant does not get so large that it prevents operation at the highest anticipated speed.

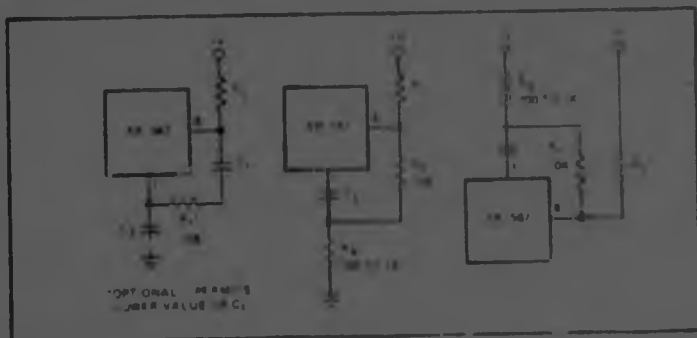

Figure 15. Methods of Reducing Chatter

SKEW ADJUSTMENT

The circuits shown in Figure 16 can be used to change the position of the detection band (capture range) within the largest detection band (or lock range). By moving the detection band to either edge of the lock range, input signal variations will expand the detection band in one direction only. Since R_3 also has a slight effect on the duty cycle, this approach may be useful to obtain a precise duty cycle when the circuit is used as an oscillator.

OUTPUT LATCHING

In order to latch the output of the XR 567 "on" after a signal is received, it is necessary to include a feedback resistor around the output stage, between pin 8 and pin 1, as shown in Figure 17. Pin 1 is pulled up to unlatch the output stage.

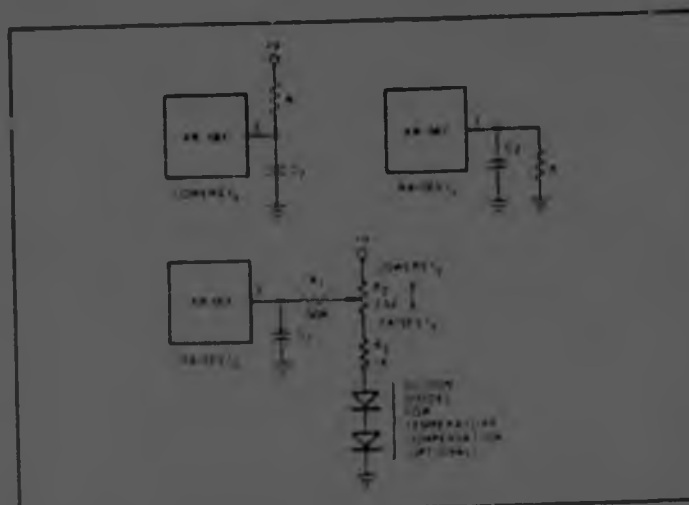

Figure 16. Connections to Reposition Detection Band

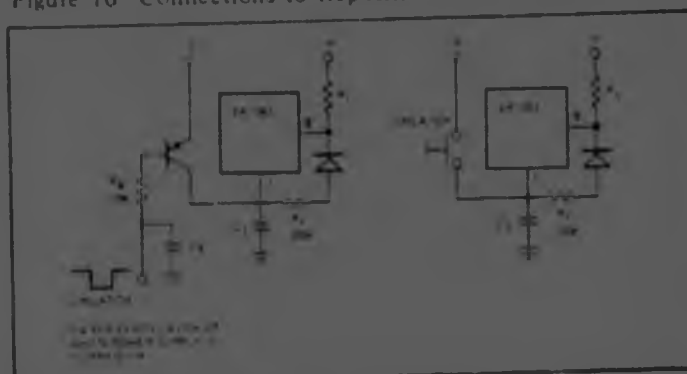

Figure 17. Output Latching

BANDWIDTH REDUCTION

The bandwidth of the XR 567 can be reduced by either increasing capacitor C_3 or reducing the loop gain. Increasing C_3 may be an undesirable solution since this will also reduce the damping of the loop and thus slow the circuit response time.

Figure 18 shows the proper method of reducing the loop gain for reduced bandwidth. This technique will improve damping and permit faster performance under narrow band operation. The reduced impedance level at pin 2 will require a larger value of C_2 for a given cutoff frequency.

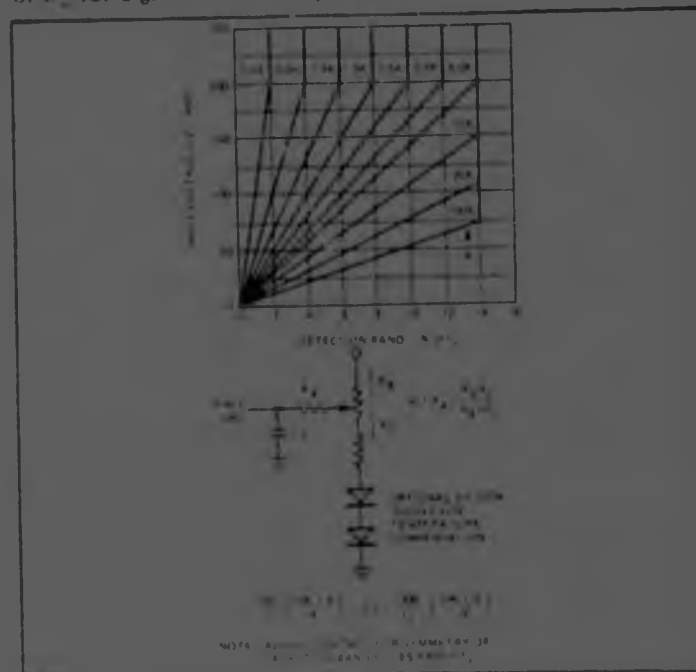

Figure 18. Bandwidth Reduction

forms are also provided in the figure. In addition to being used as a general purpose oscillator or clock generator, the CCO can also be used for any of the following special purpose oscillator applications:

1. High-Current Oscillator

The oscillator output of the XR-567 can be amplified using the output amplifier and high-current logic output available at pin 8. In this manner, the circuit can switch 100 mA load currents without sacrificing oscillator stability. A recommended circuit connection for this application is shown in Figure 23. The oscillator frequency can be modulated over $\pm 6\%$ in frequency by applying a control voltage to pin 2.

2. Oscillator with Quadrature Outputs

Using the circuit connection of Figure 24 the XR-567 can function as a precision oscillator with two separate square-wave outputs (at pins 5 and 8, respectively) that are at nearly quadrature phase with each other. Due to the internal biasing arrangement, the actual phase shift between the two outputs is typically 80° .

3. Oscillator with Frequency Doubled Output

The CCO frequency can be doubled by applying a portion of the squarewave output at pin 5 back to the input at pin 3, as shown in Figure 25. In this manner, the quadrature detector functions as a frequency doubler and produces an output of $2f_0$ at pin 8.



Figure 22. Oscillator Output Waveform Available From CCO Section
 Top: Square Wave Output at Pin 5
 Amplitude = $(V^+ - 1.4V)$, pp., Avg. Value = $V^+/2$
 Bottom: Exponential Triangle Wave at Pin 6
 Amplitude = 1 V pp., Avg. Value = $V^+/2$

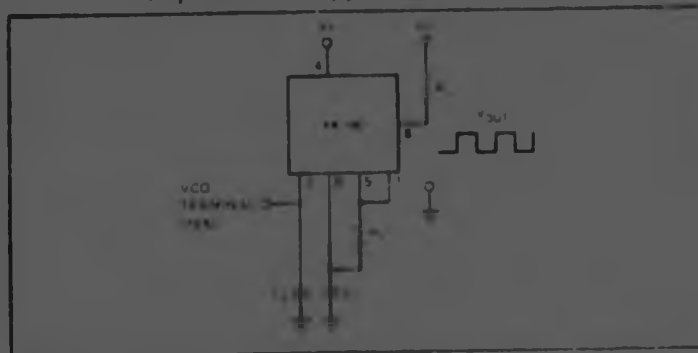

Figure 23. Precision Oscillator to Switch 100 mA Loads

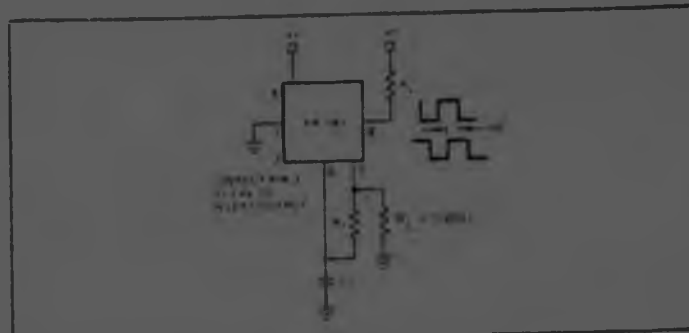

Figure 24. Oscillator with Quadrature Output

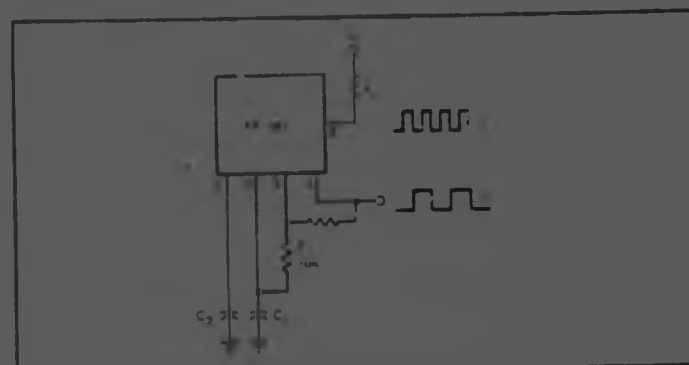

Figure 25. Oscillator with Double Frequency Output

FSK DECODING

XR-567 can be used as a low speed FSK demodulator. In this application the center frequency is set to one of the input frequencies, and the bandwidth is adjusted to leave the second frequency outside the detection band. When the input signal is frequency keyed between the *in-band* signal and the *out-band* signal, the logic state of the output at pin 8 is reversed. Figure 26 shows the FSK input ($f_2 = 3f_1$) and the demodulated output signals, with $f_0 = f_1 = 1$ kHz. The circuit can handle data rates up to $f_0/10$ baud.

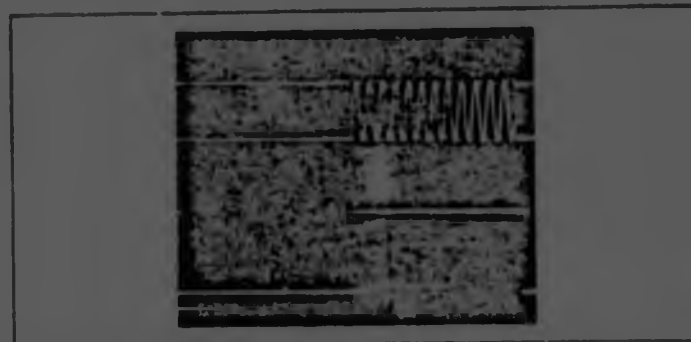

Figure 26. Input and Output Waveforms for FSK Decoding
 Top: Input FSK Signal ($f_2 = 3f_1$)
 Bottom: Demodulated Output

Application Note

AN-08

Dual Tone Decoding with XR-567 and XR-2567

INTRODUCTION

Two integrated tone decoders, XR-567 units, can be connected (as shown in Figure 1A) to permit decoding of simultaneous or sequential tones. Both units must be on before an output is given. R_1C_1 and $R'_1C'_1$ are chosen, respectively, for tones 1 and 2. If sequential tones (1 followed by 2) are to be decoded, then C_1 is made very large to delay turn-off of unit 1 until unit 2 has turned on and the NOR gate is activated. Note that the wrong sequence (2 followed by 1) will not provide an output since unit 2 will turn off before unit 1 comes on. Figure 1B shows a circuit variation which eliminates the NOR gate. The output is taken from unit 2, but the unit 2 output stage is biased off by R_2 and CR_1 until activated by tone 1. A further variation is given in Figure 1C. Here, unit 2 is turned on by the unit 1 output when tone 1 appears, reducing the standby power to half. Thus, when unit 2 is on, tone 1 is or was present. If tone 2 is now present, unit 2 comes on also and an output is given. Since a transient output pulse may appear during unit 1 turn-on, even if tone 2 is not present, the load must be slow in response to avoid a false output due to tone 1 alone.

The XR-2567 Dual Tone Decoder can replace integrated tone decoders in this application.

HIGH SPEED, NARROW BAND TONE DECODER

The circuit of Figure 1 may be used to obtain a fast, narrow band tone decoder. The detection bandwidth is achieved by overlapping the detection bands of the two tone decoders. Thus, only a tone within the overlap portion will result in an output. The input amplitude should be greater than 70 mV rms at all times to prevent detection band shrinkage and C_2 should be between $130/f_0$ and $1300/f_0$ mfd where f_0 is the nominal detection frequency. The small value of C_2 allows operation at the maximum speed so that worst case output delay is only about 14 cycles.

TOUCH TONE DECODER

Touch Tone decoding is of great interest since all sorts of remote control applications are possible if you make use of the encoder (the push-button dial) that will ultimately be part of every tone. A low-cost decoder can be made as shown in Figure 2. Seven 567 tone decoders, their inputs connected in common to a phone line or acoustical coupler, drive three integrated NOR gate packages. Each tone decoder is tuned, by means of R_1 and C_1 , to one of the seven tones. The R_2 resistor reduces the bandwidth to about 8% of 100 mV and 5% at 50 mV rms. Capacitor C_4 decouples the seven units. If you are willing to settle for a somewhat slower response at low input voltages (10 to 100 mV rms), the bandwidth can be controlled in the normal manner by selecting C_2 , thereby

eliminating the seven R_2 resistors and C_4 . In this case, C_2 would be 4.7 mfd for the three lower frequencies or 3.2 mfd for the four higher frequencies.

The only unusual feature of this circuit is the means of bandwidth reduction using the R_2 resistors. As shown in the 567 data sheet under Alternate Method of Bandwidth Reduction, the external resistor R_A can be used to reduce the loop gain and, therefore, the bandwidth. Resistor R_2 serves the same function as R_A except that instead of going to a voltage divider for dc bias it goes to a common point with the six other R_2 resistors. In effect, the five 567's which are not being activated during the decoding process serve as bias voltage sources for the R_2 resistors of the two 567's which are being activated. Capacitor C_4 (optional) decouples the ac currents at the common point.

LOW COST FREQUENCY INDICATOR

Figure 3 shows how two tone decoders set up with overlapping detection bands can be used for a go/no/go frequency meter. Unit 1 is set 6% above the desired sensing frequency and unit 2 is set 6% below the desired frequency. Now, if the incoming frequency is within 13% of the desired frequency, either unit 1 or unit 2 will give an output. If both units are on, it means that the incoming frequency is within 1% of the desired frequency. Three light bulbs and a transistor allow low cost read out.

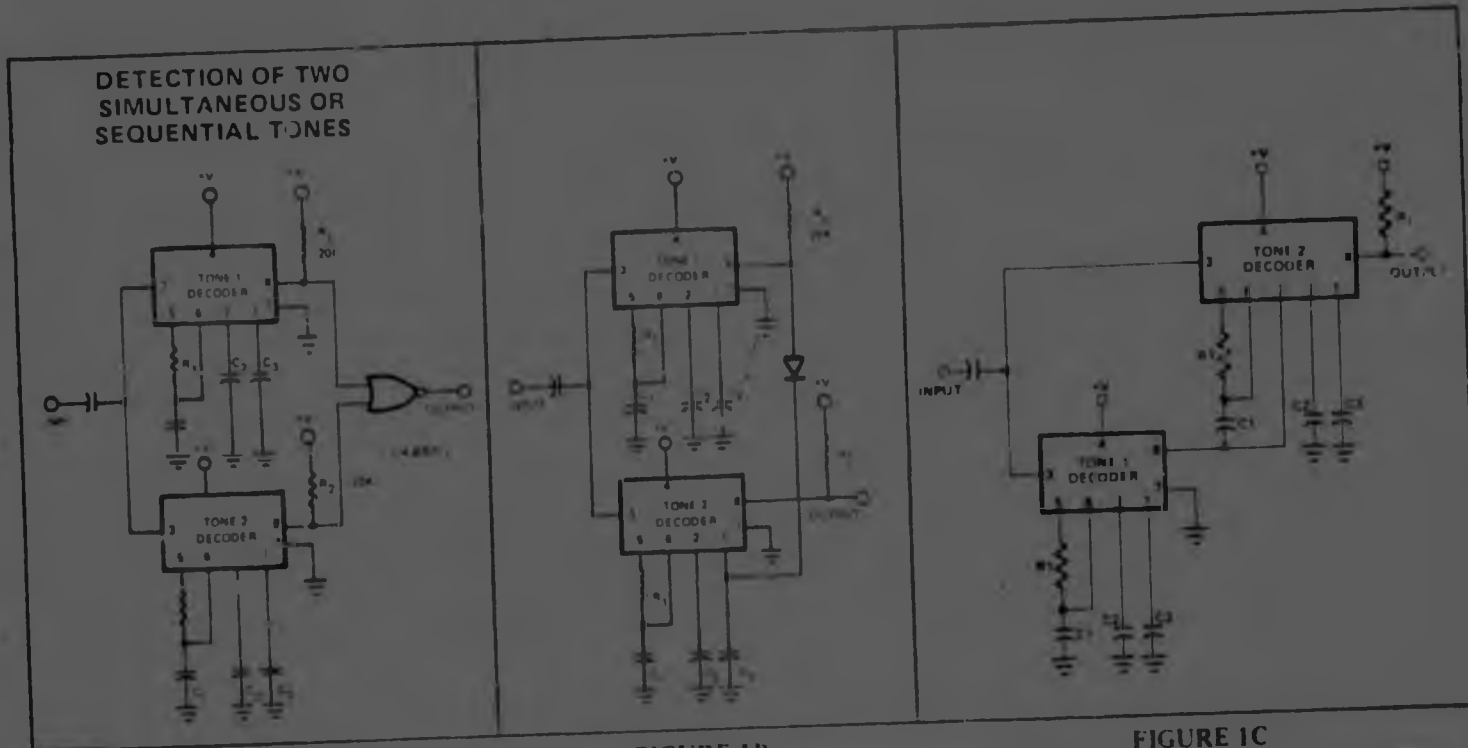

FIGURE 1A

FIGURE 1B

FIGURE 1C

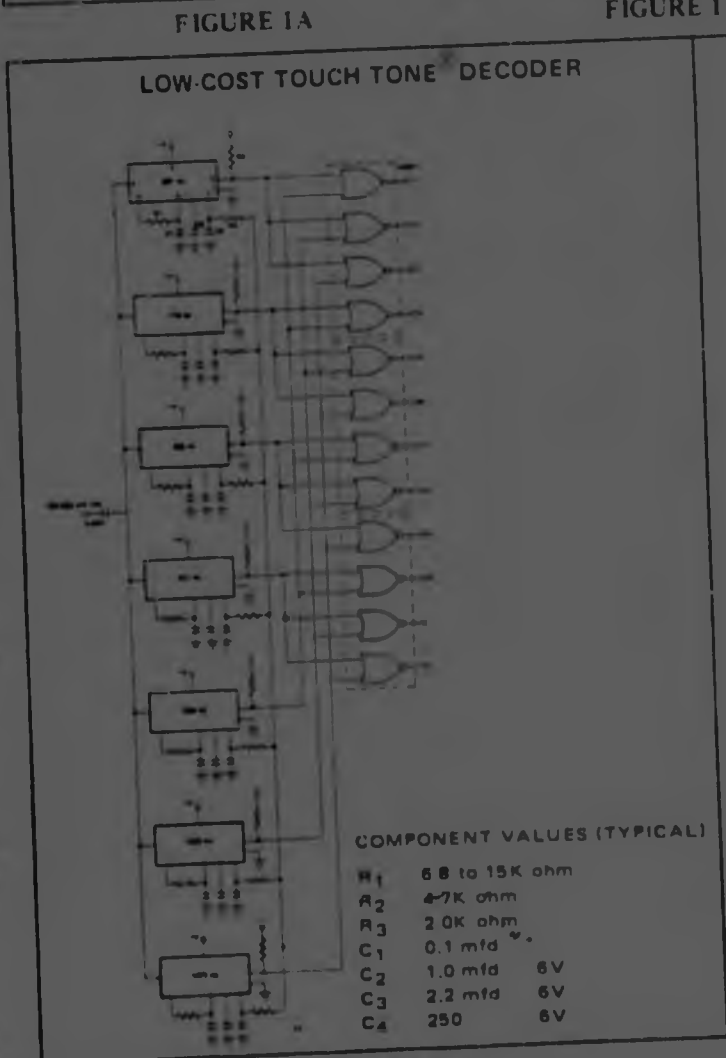

FIGURE 2

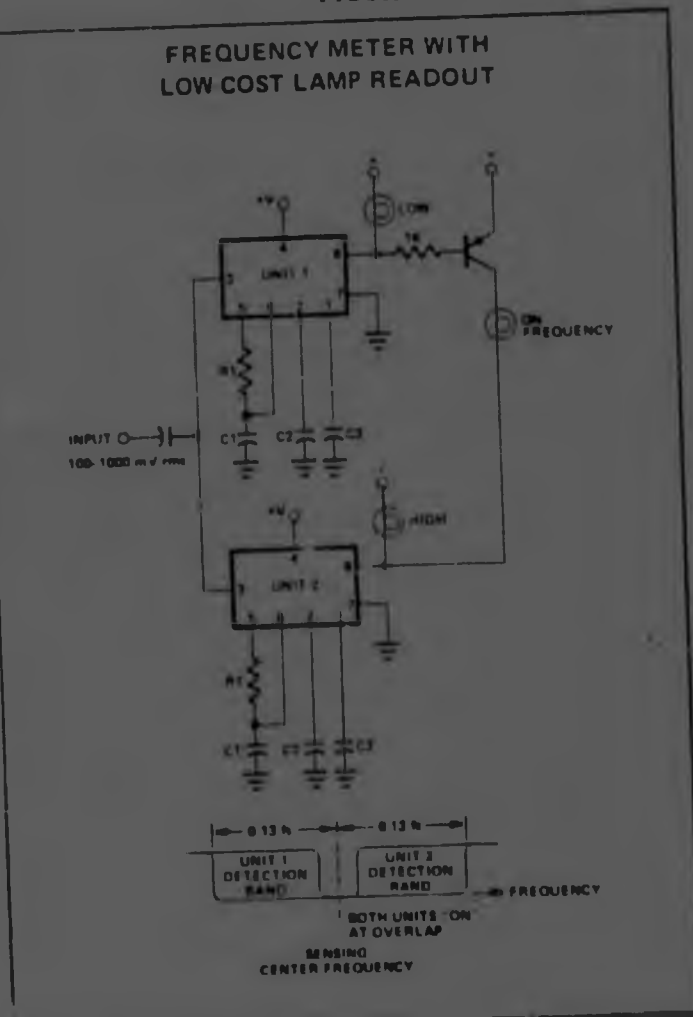

FIGURE 3

NOTE: In all code timing calculations, time = seconds, C = Micro-Farads and R = Meg-Ohms. Timing functions are of second importance and nearest preferred component values may be used.

A Group Code consists of a series of three tones, the frequencies used and their order of transmission determines the code value. The Group Code system employed for the 107 family operates according to the following rules.

1. All three tones in a Group Code are of equal nominal duration (Tp) which must be sufficient to allow recognition by a receiver. Consecutive tones in each Group Code must be of different frequency, alternate tones may, however, be repeated.
Example frequencies A, B, C and A, B, A are legal codes. A, A, B and A, B, B, are illegal codes.
3. A receiver will recognise a correctly addressed code only if consecutive tones in the group are received within a specified gate period (Receiver Gate Period Gp).
4. A minimum time interval (Quiescent Period Qp) must elapse between transmission of consecutive Group Codes, in order to avoid "alias codes", e.g. false codes based on the 'run on' tone sequences present in two consecutive Group Codes.

NOTE: Simultaneous transmission of different Group Codes over a common transmission line will inhibit decoding at the receivers being addressed. (See notes on Channel Bandwidth).

The number of unique Group Codes obtainable in a system depends on the number of tone frequencies used. For codes based on non-repeat tones (all three tones are different frequencies) the number of codes possible is $(N \times N - 1 \times N - 2)$, where N is the total number of tones available. By including legal repeat tones the number of codes rises to $(N \times N - 1 \times N - 1)$.
By way of example, if 10 tones are available in a system, the number of different Group Codes are $10 \times 9 \times 8 = 720$, using legal repeat tones this rises to $(10 \times 9 \times 9) = 810$ codes. The channel selectivity of the 107 devices is such that over 40 tone channels are easily obtainable in the 200HZ to 3KHZ audio transmission range, yielding upwards of 60,000 codes.

TX TONE PERIOD T_p ($T_p > \frac{12}{f_{tone}}$ seconds)

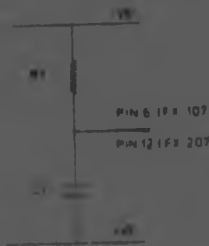

EXAMPLE

$$T_p = 0.63 R_1 C_1$$

$$\text{AND } R_1 C_1 = \frac{T_p}{0.63}$$

$$R_1 = 100K \Omega / 5M \Omega, 5\% \text{ TOL}$$

$$C_1 = 0.001 / 5MFD, 10\% \text{ TOL}$$

FIG. 6

Rx GATE PERIOD (Gp)

The tone sequence decoding circuits of the 107/307 receivers include a timing gate. This gate period is triggered (or re-triggered) as each programmed tone is received and sets the maximum time allowed for receipt of the next consecutive tone in the Group Code. If one (or two) tones in the group have been detected, but the second (or third) tone is not received within this gate period, the decode system clears down and reverts to first tone search again (FX-107) or adopts an "idling" position (FX-307 multi-code receiver).

The gate period is controlled by a single CR network (R_g & C_g) of fig. 7, which determines the period of an internal retriggerable monostable stage. Gp should always be slightly longer than Tp, and to allow for component tolerances throughout the system, a convenient general purpose value to use is Gp = 2Tp. Longer periods may be used if preferred. The calculation constant (0.63) is a design factor and subject to production tolerances of 0.6 to 0.7.

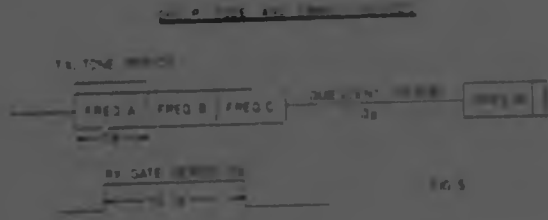
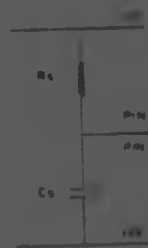

FIG. 5

Rx GATE PERIOD G_p



EXAMPLE

$$G_p = 0.63 R_g C_g$$

$$\text{AND } R_g C_g = \frac{G_p}{0.63}$$

$$R_g = 100K \Omega / 5M \Omega, 5\% \text{ TOL}$$

$$C_g = 0.001 / 5MFD, 10\% \text{ TOL}$$

FIG. 7

GROUP CODE TIMING

TX TONE PERIOD

To ensure correct recognition by a receiver, transmitter devices (107/307) must send a minimum of ten cycles of each tone in the Group Code. This is an absolute design limit and assumes accurate period timing, to allow for component and other tolerances, the recommended design minimum is twelve cycles of each tone. In a multi-station system, it is usually convenient if all stations have common values for timing components, in this case, the lowest tone frequency used in the system should be adopted as the basis for all timing calculations. Apart from this, any preferred tone length may be used.

A transmitter's tone period is controlled by a single CR network (R_t & C_t) of fig. 6, this determines the period of an internal timing stage. Note that Tp is the transmission period for one tone, the overall time for transmission of a Group Code is therefore 3Tp, there being no interval between successive tone steps with the 107/207 transmitters. The calculation constant (0.63) is a design factor and subject to production tolerances of 0.6 to 0.7.

QUIESCENT PERIOD (Qp)

The interval, between the last tone of one Group Code and the first tone of the next should not be less than period Qp, this ensures that all receiver tone gates have cleared down when the new code transmission commences and avoids alias code switching.

To allow for Gp component tolerances, particularly with multi-station systems the general basis Qp > 1.5 Gp is recommended. The rules for minimum Qp may be modified for special applications, e.g. "all station call" and "station seize" arrangements, or where consecutive Group Codes employ completely different frequencies.

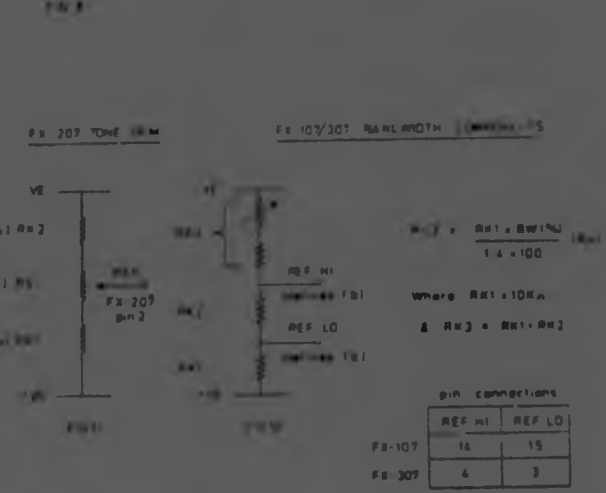
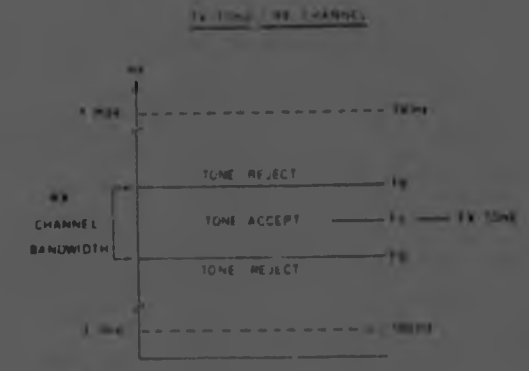
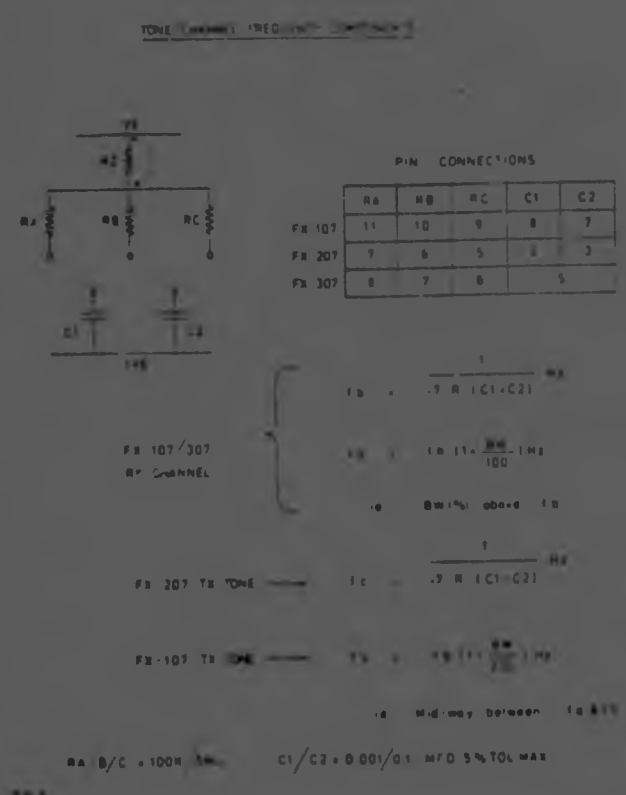

TX TONE & RX CHANNEL FREQUENCIES

Fig. 8 illustrates a typical tone channel. Provided adjacent channels do not overlap, they may be spaced as required. A tone frequency (f_c) falling between the channel edges (f_a - f_b) is recognised as an 'inband' tone.

Tone/channel frequencies are determined by resistors RA/B/C and capacitors C1/C2. (See fig 9)

Any one resistor, together with both capacitors, determines the frequency of the lower edge (f_b) of a receiver channel or, in the case of FX 207, the frequency of one tone. Commutator switches select each resistor in a programmed sequence, thus forming the Group Code.

The commutators have a low 'on' resistance, typically 300 Ω , and errors between frequency steps depend principally on the ratio tolerances between RA, RB, RC. If required, these can be minimised by including a common ballast resistor RZ, ratio errors are then reduced by a factor $\frac{RZ}{R_N}$ where R_N is the incremental resistance of the highest value.

All resistor calculations are based on total path resistance, including any value RZ.

Capacitors C1/C2 are switched alternately during Tx operation (parallel connected for Rx operation) and differences in value may unbalance the Tx output waveform. More important, unbalanced values may cause the FX 107 Tx mode tones to deviate from the centre of the corresponding Rx mode channels, this may cause difficulties in narrow channel transponder applications. Observe the recommended tolerances.

Note that two capacitors, connected to a common pin, are specified for receiver FX 307, this assists in system component standardisation (2x values are not preferred listing) and allows channel frequencies to be coded simply by standard resistor values, regardless of device type. RA/B/C and C1/C2 should all be high stability components, metal oxide resistors (1% to 2% tolerance max), and polystyrene or good grade polycarbonate capacitors are suggested.

CHANNEL BANDWIDTH

The bandwidth (BW) of a receiver tone channel is the difference in channel edge frequencies f_a and f_b , expressed as a percentage of f_b . BW is independent of operating frequency and is determined simply by the ratio of RK1 and RK2 in fig 10. These resistors form a potential divider applying reference levels to the specified pins.

The difference in the two levels determines BW, the absolute level, as a fraction of the supply, controls a constant 'K' used in frequency calculations. When REF_H1 = 50% of supply, $K = 0.7$ (as given in the formulae for fig 9), subject to a production tolerance of $\pm 1\%$ nominal.

RK3 may be used to adjust factor K and offset tolerances in components R, C1 & C2, thus calibrating one tone channel. Frequency accuracy of the remaining two channels is then subject basically to tolerances of the remaining channel resistors. With transmitter FX 207, no BW applies and only one reference level is used (see fig 11), and adjustment of K is effected via RV.

Maximum adjustment limits for reference levels are 45% to 55% of supply voltage, yielding K values of 0.6 to 0.8. Resistors used for the potential divider should be high stability types and the value of RV just sufficient to provide the required adjustment range. Convenient values for 107/307 would be $RK3 = 8.2K\Omega$ fixed resistor plus $4.7K\Omega$ RV.

Unless high channel density is mandatory, a BW value providing good margins for system tolerances should be adopted, these include temperature/supply variations, RA/B/C tolerances and, to a lesser extent, BW component tolerances. Values of 5% to 8% are suggested for general use, these can yield high code numbers (up to 14 channels/octave) with good system operating tolerances.

SPECIAL NOTE ON RECEIVERS

The RX frequency selective circuits employ a zero crossing period sampling technique which yields very sharp channel definition, coupled with exceptionally high rejection of outband noise. The period sampling principle means, however, that although it is almost impossible for adjacent channel signals, harmonics and noise to cause a false output response, the mixing of two or more frequencies can inhibit correct decoding. For this reason simultaneous transmission of different code groups over a common line should be avoided.

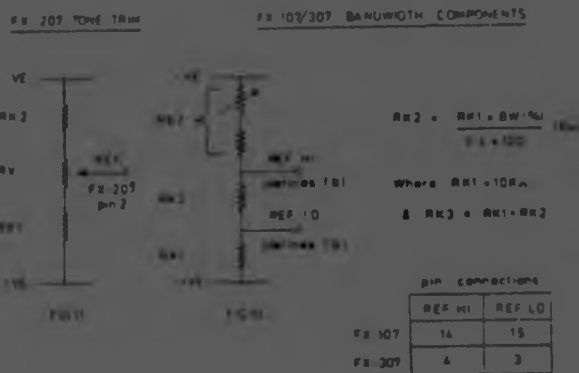
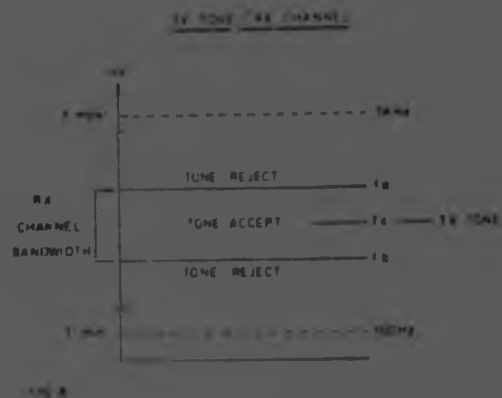
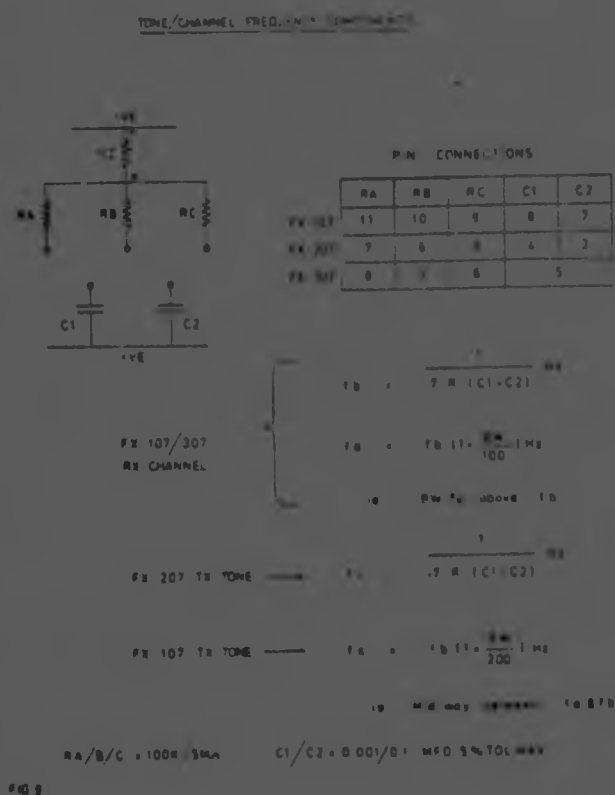

TX TONE & RX CHANNEL FREQUENCIES

Fig 8 illustrates a typical tone channel. Provided adjacent channels do not overlap, they may be spaced as required. A tone frequency (f_c) falling between the channel edges (f_a & f_b) is recognised as an 'inband' tone.

Tone/channel frequencies are determined by resistors RA/B/C and capacitors C1/C2. (See fig 9)

Any one resistor together with both capacitors, determines the frequency of the lower edge (f_b) of a receiver channel or, in the case of FX 207, the frequency of one tone. Commutator switches select each resistor in a programmed sequence, thus forming the Group Code.

The commutators have a low on resistance, typically 300 Ω, and errors between frequency steps depend principally on the ratio tolerances between RA, RB, RC. If required, these can be minimised by including a common ballast resistor RZ, ratio errors are then reduced by a factor $\frac{RZ}{RZ + RN}$ where RN is the incremental resistance of the highest value

path. All resistor calculations are based on this path resistance, including any value RZ.

Capacitors C1/C2 are switched alternately during Tx operation (parallel connected for Rx operation) and differences in value may unbalance the Tx output waveform. More important, unbalanced values may cause the FX 107 Tx-mode tones to deviate from the centre of the corresponding Rx-mode channels; this may cause difficulties in narrow channel transponder applications. Observe the recommended tolerances.

Note that two capacitors, connected to a common pin, are specified for receiver FX 307; this assists in system component standardisation (2x values are not preferred listing) and allows channel frequencies to be coded simply by standard resistor values, regardless of device type. RA/B/C and C1/C2 should all be high stability components, metal oxide resistors (1% to 2% tolerance max), and polystyrene or good grade polycarbonate capacitors are suggested.

CHANNEL BANDWIDTH

The bandwidth (BW) of a receiver tone channel is the difference in channel edge frequencies f_a and f_b , expressed as a percentage of f_b . BW is independent of operating frequency and is determined simply by the ratio of RK1 and RK2 in fig 10. These resistors form a potential divider applying reference levels to the specified pins.

The difference in the two levels determines BW, the absolute level, as a fraction of the supply, controls a constant 'K' used in frequency calculations. When REF HI = 50% of supply, $K = 0.7$ (as given in the formulae for fig 9), subject to a production tolerance of ± 1% nominal.

RK3 may be used to adjust factor K and offset tolerances in components R, C1 & C2, thus calibrating one tone channel. Frequency accuracy of the remaining two channels is then subject basically to tolerances of the remaining channel resistors. With transmitter FX 207, no BW applies and only one reference level is used (see fig 11), and adjustment of K is effected via RV.

Maximum adjustment limits for reference levels are 45% to 55% of supply voltage, yielding K values of 0.6 to 0.8. Resistors used for the potential divider should be high stability types and the value of RV just sufficient to provide the required adjustment range. Convenient values for 107/307 would be $RK3 = 8.2K\Omega$ fixed resistor plus $4.7K\Omega$ RV.

Unless high channel density is mandatory, a BW value providing good margins for system tolerances should be adopted; these include temperature/supply variations, RA/B/C tolerances and, to a lesser extent, BW component tolerances. Values of 5% to 8% are suggested for general use; these can yield high code numbers (up to 14 channels/octave) with good system operating tolerances.

SPECIAL NOTE ON RECEIVERS

The RX frequency selective circuits employ a zero crossing period sampling technique which yields very sharp channel definition, coupled with exceptionally high rejection of outband noise. The period sampling principle means, however, that although it is almost impossible for adjacent channel signals, harmonics and noise to cause a false output response, the mixing of two or more frequencies can inhibit correct decoding. For this reason simultaneous transmission of different code groups over a common line should be avoided.

SUPPLY POLARITIES

References to 'ground', '0' and '1' in this data sheet are based on use of a grounded positive supply, i.e. HT (VDD) is negative.

A '1' level is therefore near VDD (-Ve) and a '0' level is near ground (+Ve). There is, however, no objection to operation with the -Ve supply grounded, but references to logic polarities should then be inverted. It is also important to ensure that no pin is made more positive than the +Ve supply pin, or damage may result.

GENERAL INFORMATION FX-107

The FX-107 functions as either a receiver (RX) or a transmitter (TX) simultaneous operation in both modes is not possible. The rules are

- a) If the RX section has received the first tone in the Group Code, no TX action can take place until the decoding sequence is completed.
- b) If the TX section is in the process of transmitting a Group Code, the RX section is inhibited.

Otherwise, both functions are available on a 'first come, first seize' basis.

TX/RX code frequencies are determined by the values of resistors RA/RB/RC connected to pins 11, 10 and 9. A commutator selects these pins in the fixed sequence 11-10-9, the resistor value at pin 11 therefore determines the first frequency in the Group Code.

The RX section incorporates a signal amplifier, which permits operation from low level signals (A.C. coupled). High level pulse inputs (>5V) may be D.C. coupled. The RX output switch has a *bistable* action and changes state once for each correct Group Code received. The switch may be turned ON by a correct address, it then remains ON until turned OFF by repeating the address code. The switch may also be turned OFF by momentarily grounding the RX Reset input, a permanent ground will hold the output OFF regardless of input codes.

The TX section comprises a square wave tone generator driving a transistor switch coupled to the TX output pin, the TX code is determined by RA thro' RC in the same manner as the RX code. If required, different values may be used for RX and TX functions.

TX tone frequencies lie approximately central within the corresponding RX-mode channels, this is a particular advantage in transponder applications and also allows TX and RX frequency calibration to be effected simultaneously, using one common adjustment. Note that deviation from channel centre may occur if C1 & C2 are not closely toleranced (the % difference between C1 & C2 causes f_c to shift only by an equivalent % of BW total), however some deviation may also become apparent at frequencies above 3KHZ.

Transmission commences when the TX Enable input is changed from '1' to '0', one complete Group Code being sent for each 1-0 enable instruction.

Transponder gating circuits in the 107 allow a choice of transpond functions. If the TX Enable input is at '1' when an address code is received, no transpond occurs. If the enable input is permanently at ground, a reply code is transmitted on receipt of every address code. By connecting the TX Enable input to the RX output, a reply code is transmitted only when an address code is received which turns the RX output from OFF to ON.

With every transpond action there is a delay between receipt of an address and transmission of a reply, this delay is equal to Gp and commences from the moment of operation of the RX output switch. This delay is rather short for the recommended value Gp = 1.5Gp and where a single common line is used for call and reply codes, it results in two successive Group Codes appearing on-line separated by a period less than 1.5Gp. Dependant on the codes employed, this could result in alias code switching at other stations, auto-transpond operations with FX-107 are therefore best performed using separate lines for system address and system reply codes.

If the FX-107 is used only as a Receiver or a Transmitter, the associated components of the unused mode must still be fitted.

GENERAL INFORMATION FX-207

The FX-207 is a logic programmable multi-code transmitter which transmits any one of eight different Group Codes, all based on permuted sequences of the three programmed frequencies given by RA, RB and RC connected to pins 7, 6 and 5. Output frequencies are derived from a square wave tone generator driving a transistor switch coupled to the TX output pin.

Code selection is carried out by applying logic levels to the X, Y, Z inputs, either singly or in 3-line binary coded form (see fig. 12).

Two transmission modes are provided: single shot (one Group Code per TX Enable instruction) or cyclic (repetitive transmission of the selected code(s)). The required mode is obtained by appropriate inputs to the TX Enable and Enable Control pins, also as shown in fig. 12.

Each Group Code transmission is preceded by a delay interval Td, determined by an internal monostable according to the formula given in fig. 12. This delay is adjustable over wide limits, ranging from microseconds to many seconds, and allows code transmissions to be time sequenced following a common instruction, e.g. transponding of data to follow an address acknowledge by an associated device, as shown in fig. 16. It also provides the quiescent interval between successive Group Code transmissions during cyclic mode operation, the delay period being automatically re-triggered on completion of each transmitted Group Code.

Code select data may be entered or changed at any time, but only the data levels present at the instant the delay period expires are transferred to the internal store and the corresponding code transmitted. Once transmission commences it cannot be cancelled or the Group Code changed.

If no TX delay period is required note that components Rd Cd must still be fitted; use of the minimum values specified will yield Td=70 microseconds. Internal 300K pull-up resistors are fitted to the X, Y, Z inputs giving logic '1' when a pin is open circuit.

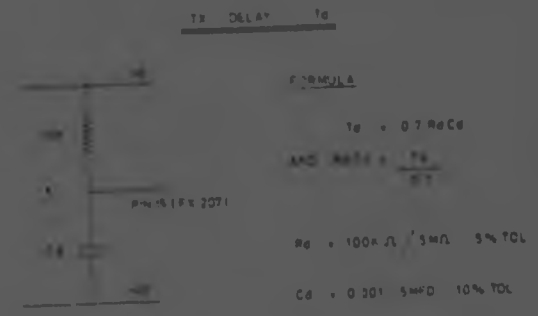

FORMULA

$$T_d = 0.7 R_d C_d$$

AND ALSO $T_d = \frac{R_1 R_2 R_3}{C_1 C_2}$

$R_d = 100 \times \Omega / 5\% \text{ TOL}$

$C_d = 0.001 / 5\% \text{ TOL}$

FIG. 12 TABLE 11-02

TX ENABLE	ENABLE CONTROL	TX OUTPUT
1	0	1 GROUP CODE
0	1	NO TX
1	1	NO TX

ENCODING							
INPUTS				OUTPUT			
X	Y	Z	SELECT	A	B	C	D
0	1	0	0	A	R	A	
0	0	1	0	C	B	A	
1	0	1	0	C	B	R	
0	1	1	0	B	C	A	
1	0	0	0	B	C	R	
1	0	1	1	A	C	B	
1	1	0	0	B	A	C	
1	1	1	0	A	B	C	

FIG 12

GENERAL INFORMATION

The FX 307 is a multi-code Receiver programmed to decode any one from eight different input Group Codes, all based on sequential combinations of the three programmed frequencies. The three code frequencies are determined by resistors RA, RB and RC connected to pins 8, 7 & 6.

Receipt of a programmed code appears at the X, Y, Z logic outputs as a 3-line binary number, the decoding truth table is shown in fig 13. Note that the encoding/decoding truth tables for 207 and 307 are identical.

Following receipt of a code the appropriate data is maintained at the X, Y, Z outputs until a different code is received or until reset by a Reset logic input. No change takes place at X, Y, Z until the displayed code is repeated. For every programmed Group Code received, including repetitive codes and irrespective of the status of the Control inputs, a pulse appears at the Code Received Output. This pulse is a 0 level maintained for approximately two cycles of the third code tone, (t = 2), the 1 - 0 going edge occurring simultaneously with any updating of the X, Y, Z outputs. The pulse may be used for strobe or display clocking purposes, and as a monitor that programmed codes are being received, even where these do not cause updating of the X, Y, Z outputs.

The two Control Mode inputs, pins 13 & 14, provide for a choice of operating modes, as shown in fig 13. Instructions to these inputs are direct acting, i.e. they are not conditional on the status of the internal tone decoding circuits. In "Update Continuously" the X, Y, Z outputs reflect continually the value of the last Group Code received. "Latch to Next" causes the X, Y, Z outputs to latch when the next input code is received, even if this is a repeat of the code displayed. "Latch as Displayed" gives immediate latching of the existing X, Y, Z output state and "Reset" switches the outputs to the state shown in fig 13.

The FX 307 is so designed that the Reset state should appear at the X, Y, Z outputs when power is first applied. If a guaranteed start up Reset state is required small capacitors should be fitted between the Control Mode inputs (1 & 2) and ground.

The signal input circuits of the FX 307 are identical to those used in the FX 107, and the same notes on signal coupling apply. The tone decoding system used in the FX 307 (and in the FX 107 RX section) will also accept input codes where each tone step is separated by an interval between successive tones, provided the Gating Period (Gp) is calculated to include these intervals. This only applies where Group Codes are transmitted from sources other than the FX 207 or FX 107 TX section.

TRUTH TABLES FOR 207

CONTROL MODE	MODE OF OPERATION
1 1	UPDATE CONTINUOUSLY
0 0	RESET (X Y Z = 111)
1 0	LATCH AS DISPLAYED
0 1	LATCH TO NEXT CODE

DECODING

INPUT	OUTPUT	
X	Y	Z
0	0	0
0	0	1
0	1	0
0	1	1
1	0	0
1	0	1
1	1	0
1	1	1

SELECTIVE SUB-STATION CALLING, WITH CALL ACKNOWLEDGE

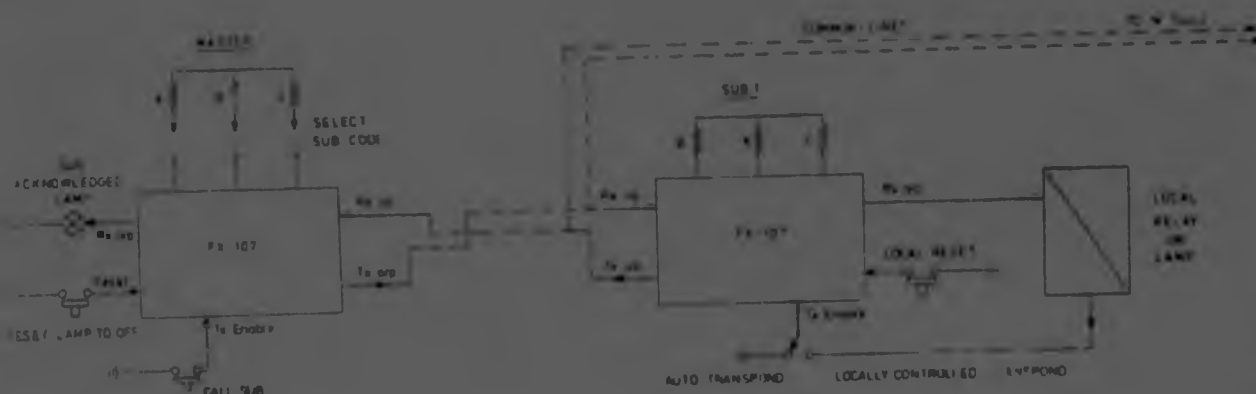

Fig. 14 shows a simple master/sub-station calling system employing FX-107's. Sub-station address codes are selected by switching RA/B/C at the master; receipt of an address code operates a local sub-station switch function.

Sub-station 107's are connected for auto-transpond and retransmit their address code each time it is received; this operates the acknowledge lamp at the master, which is ready-coded for the reply. The sub-transpond action can be locally gated, if required, to verify that the local function has switched satisfactorily.

Master and sub may be reset to OFF locally or the master can

retransmit the address, switching off the sub local circuit and (by transpond action) the master acknowledge lamp.

Separate lines are used for call and reply, due to the short transpond delay of a 107 (transpond $Q_p = G_p$). With a single line other sub-stations may respond to an alias code formed by an address followed by a transponded reply. If a transpond is locally delayed ($Q_p = 1.5 G_p$), or the same first tone used for all stations, one common line may be used for address and reply codes.

NOTE: Signals are applied between the transmission lines and a common ground line.

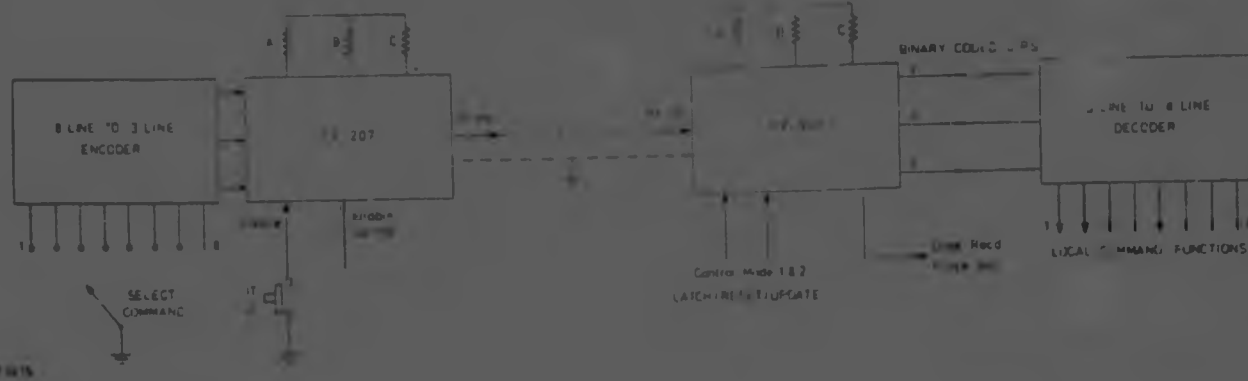
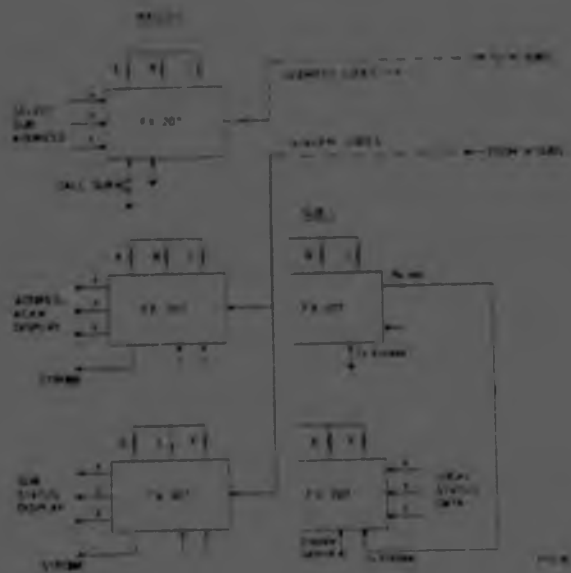

Fig 15 shows how a FX 207 can be used to transmit several coded instructions (point, using one common line. The required command code at the X, Y, Z inputs of the 207, either directly or via binary encoder illustrated, and transmitted by grounding the input. If the Enable Control is at '0' Group Code is sent for each TX Enable command. With TX '0' and Enable Control at '1' continuous code transmission, representing the current data at the X, Y, Z inputs.

Group Codes received by the remote FX 307 appear as decoded logic levels at the X, Y, Z outputs and operate appropriate local functions through the binary/octal decoder. The Code Received Output pulse may be used for strobing purposes, latching and other functions may be selected using the Control Mode inputs. The 207 encoder can be a simple diode matrix, a suitable 307 output decoder is a SN 74145 with MOS/TTL interface buffers in the X, Y, Z lines.



Sophisticated signalling functions are easily implemented using D7 series devices. Fig 16 outlines a system where remote substations are selectively addressed, receipt of an address verified and the sub-station status displayed.

Substation 107's act as address decoders and transmit an acknowledgement when called. The 107 simultaneously instructs the substation 207 to transmit the current status (alarm conditions, data etc), the 207 TX Delay period allowing sufficient time for the acknowledgement code to be cleared before data is sent.

ABC channels are used for address codes and DEF channels for data, this allows up to 8 substations to be called and the status of each verified (any 1 of 8 values). The number of outstations and status data codes can be expanded as required. Automatic station scanning can also be obtained by arranging for the Address Acknowledge display to encode the 207 Address transmitter (next address forward), the 207 may then transmit repetitively (cyclic mode) or in response to a clock from the 307 Code Received strobe output.

INTERFACES

Fig 17 shows the equivalent of an uncommitted MOS output switch employed on all the interconnecting to TTL may be achieved by a suitable choice of V_{OL} to the correct TTL input level for the supplies used. V_{OL} may be obtained by using a buffer transistor (NPN) between output and the TTL input.

- i.e. With RL only, $V_{OL} = \text{TTL logic '1'}$
- With transistor buffer, $V_{OL} = \text{TTL logic '0'}$

Each control input (TX Enab Control, Rx Reset, Control Mode 1 & 2, X, Y, Z data inputs) 100K internal pull up resistor which gives input = '1' when pin

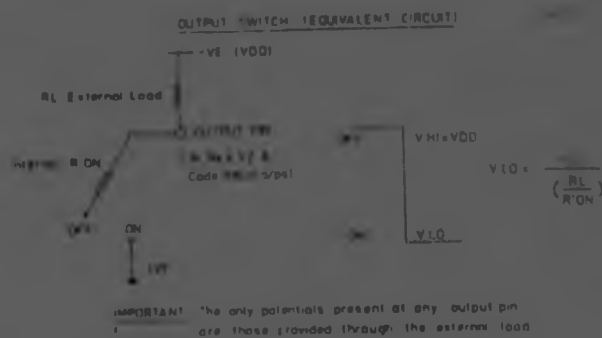

APPLICABLE TO ALL DEVICES UNLESS STATED

Max. voltage between any pin and positive supply pin. -20v & +0.3v
 Operating Temperature Range -30°C to +85°C
 Storage Temperature Range -55°C to +125°C

Max. Output Load Current (Tx, Rx, X, Y, Z & Code Rec'd O/P's) -5mA each
 Max. Device Dissipation (at 25°C T'amb) 400mW

CHARACTERISTICS

(Supply voltage - 12v ± 2v, T'amb = 25°C, operating frequencies 200 HZ to 3KHZ unless specified)

Symb	Parameter	Conditions & Notes	Min	Typ.	Max	Units
VDD	SUPPLY VOLTAGE	Operating limits	-8	-12	-15	V
IDD	SUPPLY CURRENT	Total, excluding output load current				
		FX-107/307		6		mA
		FX-207		3		
	OPERATING FREQUENCIES	Recommended operating limits, Tx Tone/Rx Channel frequencies	0.1		7	KHZ
BW	CHANNEL BANDWIDTH	Recommended limits			10	%
		FX-107/307	2			
Δf	FREQUENCY STABILITY	Tx/Rx Frequency stability vs Supply Volts & T'amb. Ext. component co-efficient excluded.		0.04		%/%
		SUPPLY T'AMB		0.01		%/°C
Vin	SIGNAL AMPLITUDE RANGE	Sine or pulse input signals, A.C. coupled. Input impedance typically 50 KΩ.	0.1		15	V pk-pk
		FX-107/307				
R'on	OUTPUT 'ON' RESISTANCE	Tx, Rx, X, Y, Z & Code Rec'd Outputs. Internal resistance between O/P pin & ground with switch 'ON' ('OFF' resistance > 10MΩ)		0.3	1	KΩ
'1'	LOGIC HIGH	Logic levels to all control inputs (Internal 300KΩ pull-up resistors give logic '1' when pin O/C)	'1'	-6	-15	V
'0'	LOGIC LOW		'0'	0	-1.5	V

NOTE: Where VDD is below -10v, devices may latch up if VDD is applied at a slowly increasing rate. To avoid low VDD latch-up, supplies should rise from zero to VDD in 10mS max.

COMPONENT EXAMPLES FOR SIX TONE FREQUENCIES AND CORRESPONDING TIME PERIODS, WITH VARIOUS CHANNEL BANDWIDTH OPTIONS.

Values for RA/B/C & C1/2 vs Frequency

R	C1	C2	HZ
270KΩ	3300pf.	3300pf	801
220KΩ			983
180KΩ			1202
150KΩ			1443
120KΩ			1803
100KΩ			2164

Bandwidth vs Rk2. Typical Values

Bandwidth	Rk2
4.5%	330Ω
5.0%	360Ω
6.0%	430Ω
9.5%	680Ω

Where Rk1 = 10KΩ

Timing Period Components Minimum periods, based on use of 801 Hz.

Rt	Ct	Tp
270KΩ	0.1MFD	17mS

Rt	Ct	Tp
560KΩ	0.1MFD	35mS

Three printed circuit cards, types C-07, C-072, C-073 are available to assist in laboratory assessment and system development work using devices from the '07 family. The cards are purposely made larger than necessary, to facilitate easy assembly of various sized components, but apart from this they are also suitable for short-run production use.

Manufactured from 1/16" S.H.B.P. with tinned copper conductors, they measure 4" (103mm) x 3" (76mm) and all component positions are clearly printed on one side. Card connections are shown by printed letter code. The cards are supplied complete with a set of press-in terminal posts for mounting those components most likely to be changed during experiments, thus minimising possible damage to the metal tracks. Components are not supplied. Connection to the cards may be made by direct wiring or by edge connectors, using a 12 way 0.15" pitch P.C.B. Socket. Normally, the FX device is soldered directly into position, but a 16 way D.I.L. socket may be used if required. Care must be taken to ensure that supply polarities are correct, as a reverse voltage can damage the devices. References to logic level polarities in this data sheet are based on use of a grounded positive supply, but there is no specific objection to operation with a grounded negative supply.

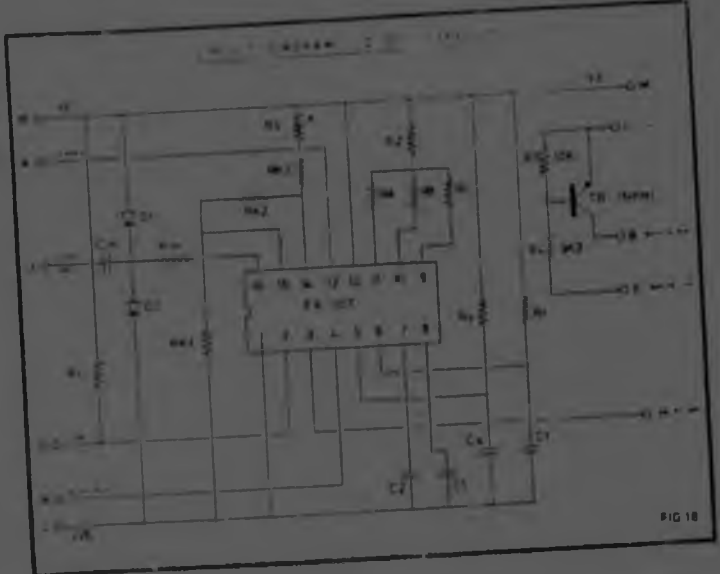

CIRCUIT NOTES

Card C-07 has provision for a NPN transistor which may be used as a buffer for the Rx or Tx output as required. Connect C to M, or a higher -ve supply, with the external load between B and L. Cards C-07 and C-073 have provision for A.C. signal coupling via C'in. Input protection diodes D1 and D2 may be fitted where line over-voltages or transients are expected at the signal input. R'in should then be 10K ohms to limit input current. For normal use R'in should be a wire link. Load resistors (RL) must be fitted to obtain voltage swings at the Tx O/P. Where several Tx O/P's are connected to a common line, only one RL is necessary as a common load. If RZ ballast is not required, a shorting link must be fitted. The connection sequence of RA/B/C on P.C.B. C-07 may be externally switched by mounting RA/B/C in the alternative adjacent positions and using the numbered connecting holes

COMPONENT NOTES.

- | | | | |
|-----------|--------------------------------|------|--|
| D1 and D2 | (Optional) 1N914 or similar. | T1 | TO 5 silicon NPN, rating to suit load. |
| RV | Plessey type WRM or equivalent | C'in | 0.1MFD typical |

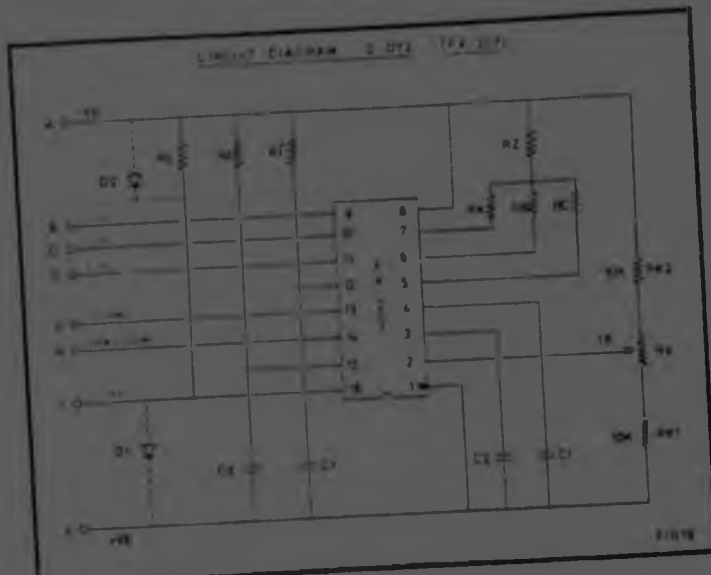

CALIBRATING TONE CHANNEL FREQUENCIES

To calibrate the FX-107 and FX-207, switch on supplies and allow a few seconds for the circuit to stabilise. Check that a tone burst appears at the Tx O/P when Tx Enable instructed. Temporarily connect a shorting link across Ct. Connect frequency measuring equipment to the Tx O/P and momentarily ground the Tx Enable input. Adjust Rv until the correct Tx frequency (f'c) for tone A is obtained (tone is transmitted continuously). Set f'c centrally between f'a & f'b of corresponding Rx channel. Remove shorting link and temporarily connect a large value capacitor (10MFD) across Ct. Momentarily ground Tx Enable again and the device will step through the three code frequencies at a slow step-rate, all three tone frequencies may then be read off. No further adjustment is necessary.

A source of accurate Group Code frequencies is required to calibrate a FX-307; the simplest method is to use a FX 207 arranged to transmit a repetitive code using the correct frequencies. Connect an oscilloscope to the FX-307 Code Received Pulse output, which must have a load resistor fitted. Control Mode inputs 1 & 2 should both be a '1' level (open circuit). Apply code signals from the 207 to the 307 signal input and adjust RV on C-073 until output pulses are displayed on oscilloscope (one pulse shown for each Group Code received). Set RV to mid-position of adjustment range over which pulses appear. No further adjustment is necessary.

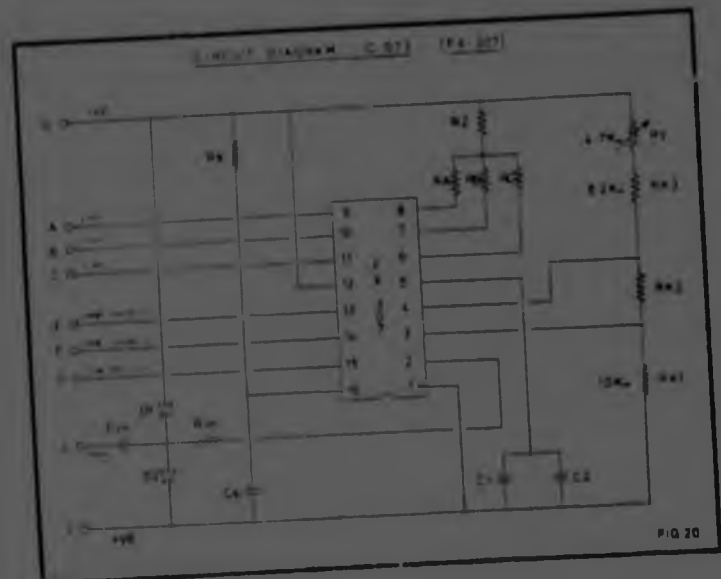

CONSUMER MICROCIRCUITS LIMITED
 WHEATON ROAD INDUSTRIAL ESTATE EAST
 WITHAM ESSEX CM8 3TD ENGLAND

AEN PRINTERS LTD

Telex: 99382
 Cables: Reaction Witham
 Telephone: Witham 3833/4/5

APPENDIX 2DESIGN ANALYSIS OF CARRIER OSCILLATOR CIRCUIT

As given in the data sheet (see later in this appendix) the frequency of oscillation of the XR 2206 oscillator is determined by an external resistor and capacitor and is given by

$$f_o = \frac{1}{RC}$$

As discussed in chapter 4, where the temperature stability of the oscillator is inadequate, the drift of frequency with temperature can be eliminated by the selection of the correct combination of negative and positive temperature coefficient components.

A parallel combination of two capacitors (for the frequency determining capacitor) can be used and the mathematical derivation of all appropriate equations follows.³⁵

For two capacitors (C_1 and C_2) in parallel the capacitance is

$$C = C_1 + C_2 \dots\dots (1)$$

The general partial differential equation is

$$\frac{dC}{dT} = \left(\frac{\partial C}{\partial C_1} \right)_{C_2} \frac{dC_1}{dT} + \left(\frac{\partial C}{\partial C_2} \right)_{C_1} \frac{dC_2}{dT} \dots\dots (2)$$

from (1)

$$\left(\frac{\partial C}{\partial C_1} \right)_{C_2} = 1 \quad \text{and} \quad \left(\frac{\partial C}{\partial C_2} \right)_{C_1} = 1$$

Now if a capacitor of value C increases to value $C + \Delta C$ for a temperature change ΔT , the temperature coefficient is defined as

$$\alpha_c = \frac{1}{C} \frac{\Delta C}{\Delta T} \dots\dots (3)$$

This gives the change in capacitance per unit capacitance per degree Celsius. Substituting the two partial derivatives and equation (3) in (2) we get

$$(C_1 + C_2) \alpha_c = C_1 (\alpha_{c1}) + C_2 (\alpha_{c2})$$

$$\alpha_c = \left(\frac{C_1}{C_1 + C_2} \right) \alpha_{c1} + \left(\frac{C_2}{C_1 + C_2} \right) \alpha_{c2}$$

$$\text{i.e. } \alpha_c = \frac{(C_1)}{(C)} \alpha_{c1} + \frac{(C - C_1)}{(C)} \alpha_{c2} \dots\dots (4)$$

For the 2206 carrier oscillator, the frequency of oscillation is given by

$$f = \frac{1}{RC} \dots\dots (5)$$

Again one can write the partial differential equation

$$\frac{df}{dT} = \left(\frac{\partial f}{\partial R} \right) \frac{dR}{dT} + \left(\frac{\partial f}{\partial C} \right) \frac{dC}{dT} \dots\dots (6)$$

The partial differentials of (5) are

$$\begin{aligned} \left(\frac{\partial f}{\partial R} \right)_C &= -\frac{1}{CR^2} & \left(\frac{\partial f}{\partial C} \right)_R &= -\frac{1}{RC^2} \\ &= -\frac{f}{R} & &= -\frac{f}{C} \end{aligned}$$

Substituting in (6) we get

$$\frac{1}{f} \frac{df}{dT} = - \left(\frac{1}{R} \frac{dR}{dT} + \frac{1}{C} \frac{dC}{dT} \right)$$

$$\text{i.e. } \alpha_f = - (\alpha_R + \alpha_C) \dots\dots (7)$$

For a circuit with a temperature coefficient (TC) of frequency α_f^1 , we have a TC of capacitance α_C^1 . If the TC of capacitance is changed to α_C^{11} we get a TC of frequency α_f^{11} (with α_R remaining constant).

Using (7)

$$\alpha_f^1 = -\alpha_R - \alpha_C^1$$

and

$$\alpha_f^{11} = -\alpha_R - \alpha_C^{11}$$

and combining these we get

$$\alpha_f^1 + \alpha_f^{11} + \alpha_C^{11} - \alpha_C^1 \dots (8)$$

Since we require the circuit to have TC of frequency equal to zero, (8) becomes

$$\alpha_C^{11} = \alpha_C^1 + \alpha_f^1 \dots (9)$$

The use of these equations is described in chapter 4.

XR-2206

Monolithic Function Generator

The XR-2206 is a monolithic function generator integrated circuit capable of producing high quality sine, square, triangle, ramp and pulse waveforms of high stability and accuracy. The output waveforms can be both amplitude and frequency modulated by an external voltage. Frequency of operation can be selected externally over a range of 0.01 Hz to more than 1 MHz.

The XR-2206 is ideally suited for communications, instrumentation, and function generator applications requiring sinusoidal tone, AM, FM or FSK generation. It has a typical drift specification of 20 ppm/°C. The oscillator frequency can be linearly swept over a 2000:1 frequency range with an external control voltage with very little affect on distortion.

As shown in Figure 1, the monolithic circuit is comprised of four functional blocks: a voltage-controlled oscillator (VCO); an analog multiplier and sine-shaper; a unity gain buffer amplifier; and a set of current switches. The internal current switches transfer the oscillator current to any one of the two external timing resistors to produce two discrete frequencies selected by the logic level at the FSK input terminal (pin 9).

FEATURES

- Low Sine wave Distortion (THD .5%) – insensitive to signal sweep
- Excellent Stability (20 ppm/°C, typ)
- Wide Sweep Range (2000:1, typ)
- Low Supply Sensitivity (0.01%/V, typ)
- Linear Amplitude Modulation
- Adjustable Duty-Cycle (1% to 99%)
- TTL Compatible FSK Controls
- Wide Supply Range (10V to 26V)

APPLICATIONS

- Waveform Generation
Sine, Square, Triangle, Ramp
- Sweep Generation
- AM/FM Generation
- FSK and PSK Generation
- Voltage-to-Frequency Conversion
- Tone Generation
- Phase-Locked Loops

EQUIVALENT SCHEMATIC DIAGRAM

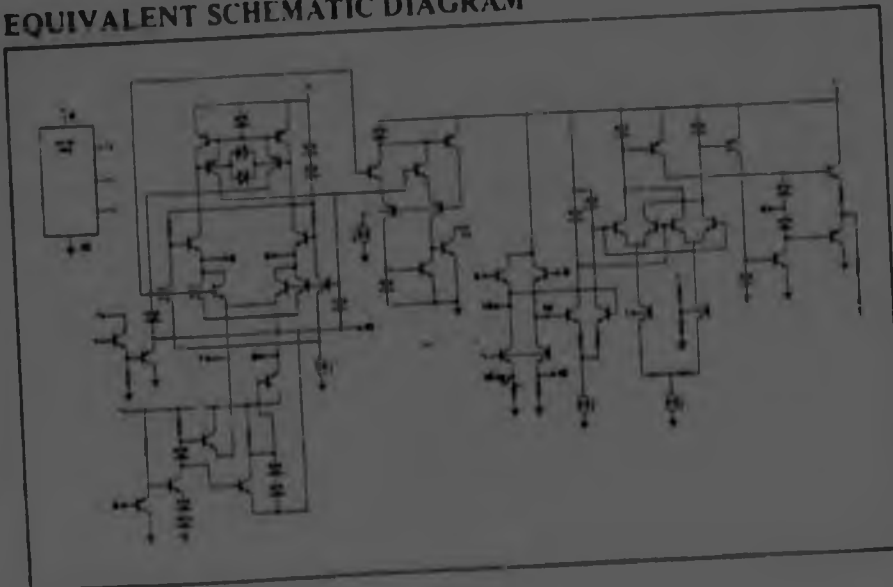

ABSOLUTE MAXIMUM RATINGS

Power Supply	26V
Power Dissipation (package limitation)	750 mW
Ceramic package	6.0 mW/°C
Derate above +25°C	625 mW
Plastic package	5 mW/°C
Derate above +25°C	-65°C to +150°C
Storage Temperature Range	

AVAILABLE TYPES

Part Number	Package Types	Operating Temperature Range
XR-2206M	Ceramic	-55°C to +125°C
XR-2206N	Ceramic	0°C to +75°C
XR-2206P	Plastic	0°C to +75°C
XR-2206CN	Ceramic	0°C to +75°C
XR-2206CP	Plastic	0°C to +75°C

FUNCTIONAL BLOCK DIAGRAM

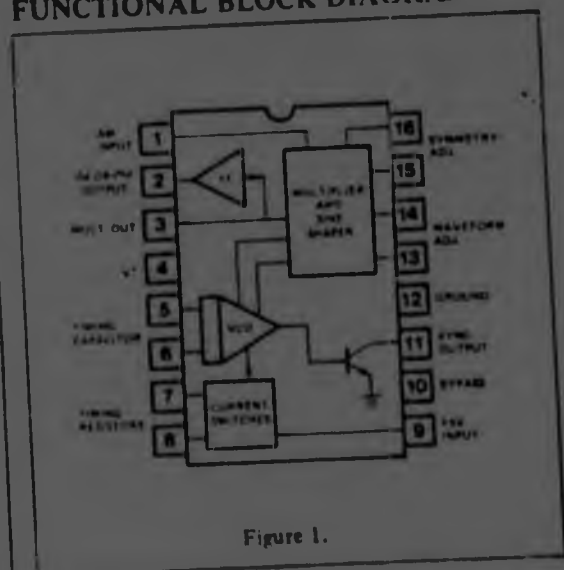

Figure 1.

ELECTRICAL CHARACTERISTICS

Test Conditions: Test Circuit of Fig. 2, $V^+ = 12V$, $T_A = 25^\circ C$, $C = 0.01 \mu F$, $R_1 = 100 K\Omega$, $R_2 = 10 K\Omega$, $R_3 = 25 K\Omega$ unless otherwise specified. S_1 open for triangle, closed for sine wave.

CHARACTERISTICS	XR-2206/XR-2206M			XR-2206C			UNITS	CONDITIONS
	MIN.	TYP.	MAX.	MIN.	TYP.	MAX.		
Supply Voltage	10		26	10		26	V	$R_1 \geq 10 K\Omega$
Single Supply	± 5		± 13	± 5		± 13	V	
Split Supply		12	17		14	20	mA	
Supply Current								
Oscillator Section	0.5	1		0.5	1		MHz	$C = 1000 \text{ pF}$, $R_1 = 1 K\Omega$ $C = 50 \mu F$, $R_1 = 2 M\Omega$ $f_0 = 1/R_1 C$ $0^\circ C \leq T_A \leq 75^\circ C$, $R_1 = R_2 = 20 K\Omega$ $V_{LOW} = 10V$, $V_{HIGH} = 20V$, $R_1 = R_2 = 20 K\Omega$
Max. Operating Frequency		0.01			0.01		Hz	
Lowest Practical Frequency		± 1	± 4		± 2		% of f_0	
Frequency Accuracy		± 10	± 50		± 20		ppm/ $^\circ C$	
Temperature Stability		0.01	0.1		0.01		%/V	
Supply Sensitivity								
Sweep Range	1000:1	2000:1			2000:1		$f_H = f_L$	$f_H @ R_1 = 1 K\Omega$ $f_L @ R_1 = 2 M\Omega$
Sweep Linearity								$f_L = 1 \text{ kHz}$, $f_H = 10 \text{ kHz}$
10:1 Sweep								$f_L = 100 \text{ Hz}$, $f_H = 100 \text{ kHz}$
1000:1 Sweep								$\pm 10\%$ Deviation
FM Distortion								
Recommended Timing Components								
Timing Capacitor, C	0.001		100	0.001		100	μF	See Figure 5
Timing Resistors: R_1 & R_2	1		2000	1		2000	$K\Omega$	
Triangle/Sinewave Output								See Note 1, Fig. 2 Fig. 2 S_1 Open Fig. 2 S_1 Closed
Triangle Amplitude	40	160	80		160		mV/ $K\Omega$	
Sinewave Amplitude		60			60		mV/ $K\Omega$	
Max. Output Swing		6			6		V _{pp}	
Output Impedance		600			600		Ω	
Triangle Linearity		1			1		dB	
Amplitude Stability		0.5			0.5		ppm/ $^\circ C$	
Sinewave Amplitude Stability		-4800			-4800			
Sinewave Distortion								$R_1 = 30 K\Omega$ See Figure 11 See Figure 12
Without Adjustment		2.5			2.5		%	
With Adjustment		0.4	1.0		0.5	1.5	%	
Amplitude Modulation								For 95% modulation Measured at Pin 11
Input Impedance	50	100		50	100		$K\Omega$	
Modulation Range		100			100		dB	
Carrier Suppression		55			55		dB	
Linearity		2			2		dB	
Square Wave Output								$C_L = 10 \text{ pF}$ $C_L = 10 \text{ pF}$ $I_L = 2 \text{ mA}$ $V_{II} = 26V$
Amplitude		12			12		V _{pp}	
Rise Time		250			250		nsec	
Fall Time		50			50		nsec	
Saturation Voltage		50			50		V	
Leakage Current		0.2	0.4		0.2	0.6	μA	
FSK Keying Level (Pin 9)		0.1	20		0.1	100	μA	See Section on Circuit Controls
Reference Bypass Voltage	0.8	1.4	2.4	0.8	1.4	2.4	V	Measured at Pin 10.

Note 1: Output Amplitude is directly proportional to the resistance R_3 on Pin 3. See Figure 3.
Note 2: For maximum amplitude stability R_3 should be a positive temperature coefficient resistor.

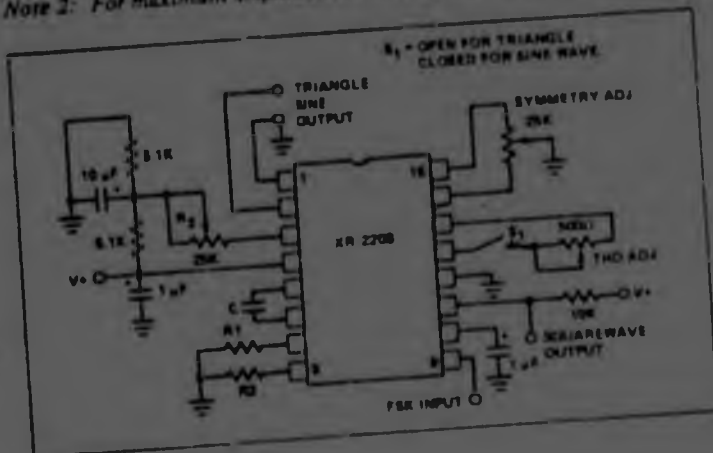

Figure 2. Basic Test Circuit

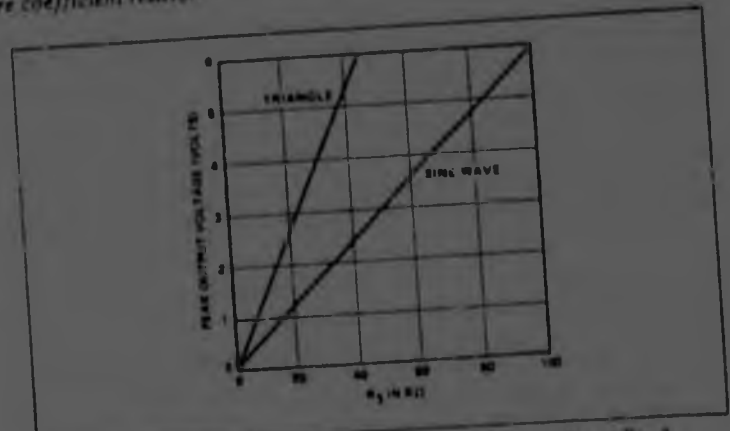

Figure 3. Output Amplitude as a Function of Resistor R_3 at Pin 3.

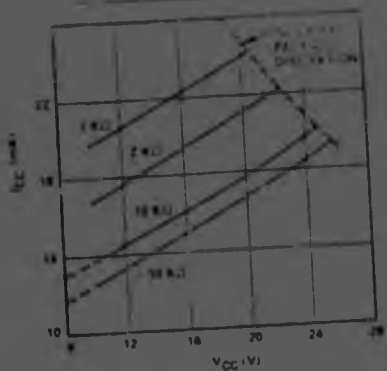

Figure 4 Supply Current vs Supply Voltage, Timing R

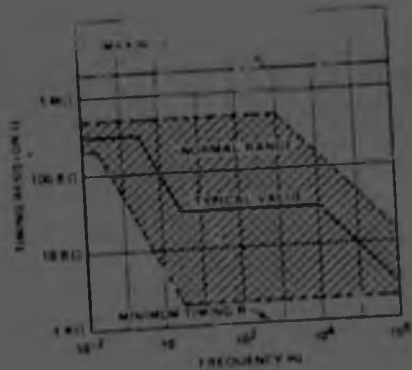

Figure 5. R vs Oscillation Frequency

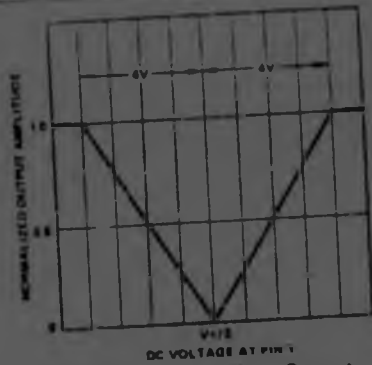

Figure 6 Normalized Output Amplitude vs DC Bias at AM Input (Pin 1).

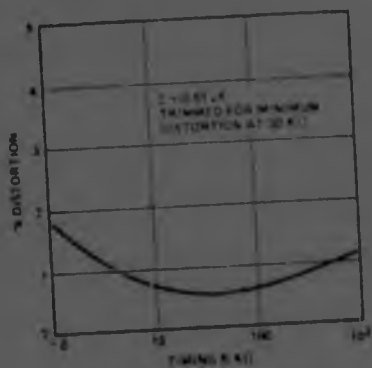

Figure 7. Trimmed Distortion vs Timing Resistor

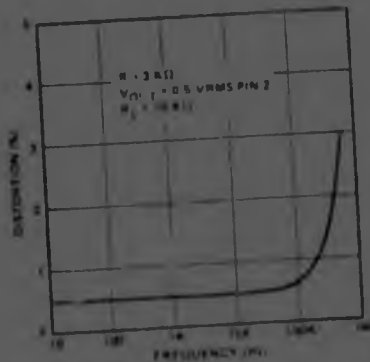

Figure 8 Sinewave Distortion vs Operating Frequency With Timing Capacitors Varied

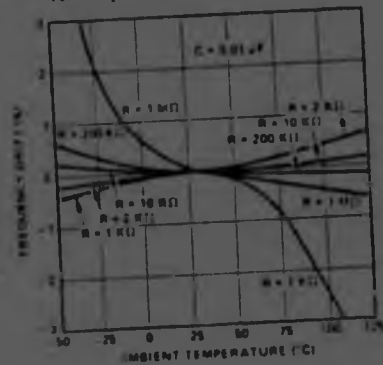

Figure 9. Frequency Drift vs Temperature

DESCRIPTION OF CIRCUIT CONTROLS

FREQUENCY OF OPERATION:

The frequency of oscillation, f_o , is determined by the external timing capacitor C across pins 5 and 6, and by the timing resistor R connected to either pin 7 or pin 8. The frequency is given as

$$f_o = \frac{1}{RC} \text{ Hz}$$

and can be adjusted by varying either R or C . The recommended values of R for a given frequency range are shown in Figure 5. Temperature stability is optimum for $4 \text{ K}\Omega < R < 200 \text{ K}\Omega$. Recommended values of C are from 1000 pF to $100 \mu\text{F}$.

FREQUENCY SWEEP AND MODULATION

Frequency of oscillation is proportional to the total timing current I_T drawn from pin 7 or 8

$$f = \frac{320I_T \text{ (mA)}}{C \text{ (}\mu\text{F)}} \text{ Hz}$$

Timing terminals (pins 7 or 8) are low impedance points and are internally biased at $+3\text{V}$, with respect to pin 12. Frequency varies linearly with I_T over a wide range of current values, from $1 \mu\text{A}$ to 3 mA . The frequency can be controlled by applying a control voltage, V_C , to the activated timing pin as shown in Figure 10. The frequency of oscillation is related to V_C as:

$$f = \frac{1}{RC} \left[1 + \frac{R}{RC} \left(1 - \frac{V_C}{3} \right) \right] \text{ Hz}$$

where V_C is in volts. The voltage-to-frequency conversion gain, K , is given as:

$$K = \frac{\partial f}{\partial V_C} = -\frac{0.32}{RC} \text{ Hz/V}$$

NOTE. For safe operation of the circuit I_T should be limited to $\leq 3 \text{ mA}$.

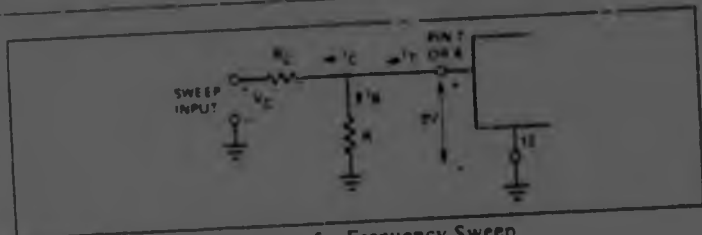

Figure 10: Circuit Connection for Frequency Sweep

OUTPUT CHARACTERISTICS:

Output Amplitude: Maximum output amplitude is directly proportional to external resistor R_3 connected to Pin 3 (See Fig. 3). For sinewave output, amplitude is approximately 60 mV peak per $\text{K}\Omega$ of R_3 , for triangle, the peak amplitude is approximately 160 mV peak per $\text{K}\Omega$ of R_3 . Thus, for example, $R_3 = 50 \text{ K}\Omega$ would produce approximately $\pm 3\text{V}$ sinusoidal output amplitude.

Amplitude Modulation: Output amplitude can be modulated by applying a dc bias and a modulating signal to Pin 1. The internal impedance at Pin 1 is approximately $100 \text{ K}\Omega$. Output amplitude varies linearly with the applied voltage at Pin 1, for values of dc bias at this pin, within ± 4 volts of $V^+/2$ as shown in Fig. 6. As this bias level approaches $V^+/2$, the phase of the output signal is reversed; and the amplitude goes through zero. This property is suitable for phase-shift keying and suppressed-carrier AM generation. Total dynamic range of amplitude modulation is approximately 55 dB .

Note. AM control must be used in conjunction with a well-regulated supply since the output amplitude now becomes a function of V^+ .

FREQUENCY-SHIFT KEYING

The XR-2205 can be operated with two separate timing resistors, R_1 and R_2 , connected to the timing pins 7 and 8, respectively, as shown in Figure 13. Depending on the polarity of the logic signal at pin 9, either one or the other of these timing

resistor is activated. If pin 9 is open-circuited or connected to a bias voltage $> 2V$, only R_1 is active. Similarly, if the voltage level at pin 9 is $< 1V$, only R_2 is activated. Thus, the output frequency can be keyed between two levels, f_1 and f_2 as:

$$f_1 = 1/R_1C \text{ and } f_2 = 1/R_2C$$

For split-supply operation, the keying voltage at pin 9 is referenced to V^- .

OUTPUT DC LEVEL CONTROL

The dc level at the output (pin 2) is approximately the same as the dc bias at pin 3. In Figures 11, 12 and 13, pin 3 is biased mid-way between V^+ and ground, to give an output dc level of $\approx V^+/2$.

APPLICATIONS INFORMATION

SINEWAVE GENERATION

A) Without External Adjustment

Figure 11 shows the circuit connection for generating a sinusoidal output from the XR-2206. The potentiometer R_1 at pin 7 provides the desired frequency tuning. The maximum output swing is greater than $V^+/2$ and the

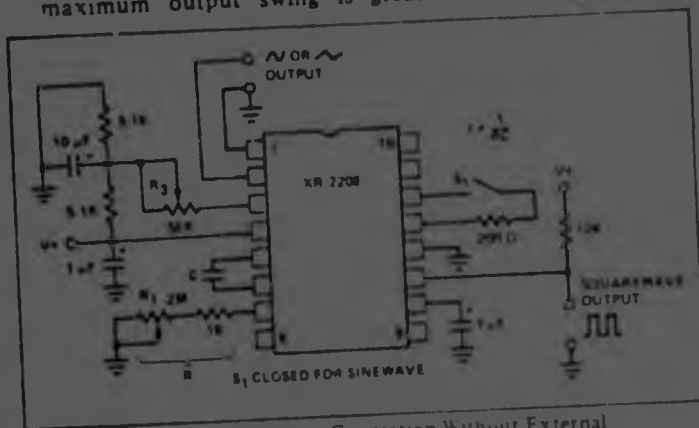

Figure 11. Circuit for Sinewave Generation Without External Adjustment. (See Fig. 3 for choice of R_3)

typical distortion (THD) is $< 2.5\%$. If lower sinewave distortion is desired, additional adjustments can be provided as described in the following section.

The circuit of Figure 11 can be converted to split supply operation simply by replacing all ground connections with V^- . For split supply operation, R_3 can be directly connected to ground.

B) With External Adjustment

The harmonic content of sinusoidal output can be reduced to $\approx 0.5\%$ by additional adjustments as shown in Figure 12. The potentiometer R_A adjusts the sine-shaping resistor.

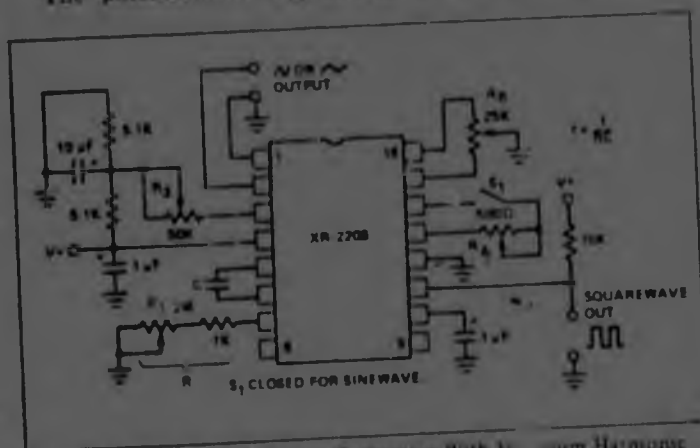

Figure 12. Circuit for Sinewave Generation With Minimum Harmonic Distortion. (R_3 Determines output Swing - See Fig. 3)

and R_B provides the fine adjustment for the wave symmetry. The adjustment procedure is as follows:

1. Set R_B at mid-point and adjust R_A for minimum distortion.
2. With R_A set as above, adjust R_B to further reduce distortion.

TRIANGLE WAVE GENERATION

The circuits of Figures 11 and 12 can be converted to triangle wave generation by simply open-circuiting pins 13 and 14 (i.e., S_1 open). Amplitude of the triangle is approximately twice the sinewave output.

FSK GENERATION

Figure 13 shows the circuit connection for sinusoidal FSK signal generation. Mark and space frequencies can be independently adjusted by the choice of timing resistors R_1 and R_2 , and the output is phase-continuous during transitions. The keying signal is applied to pin 9. The circuit can be converted to split-supply operation by simply replacing ground with V^- .

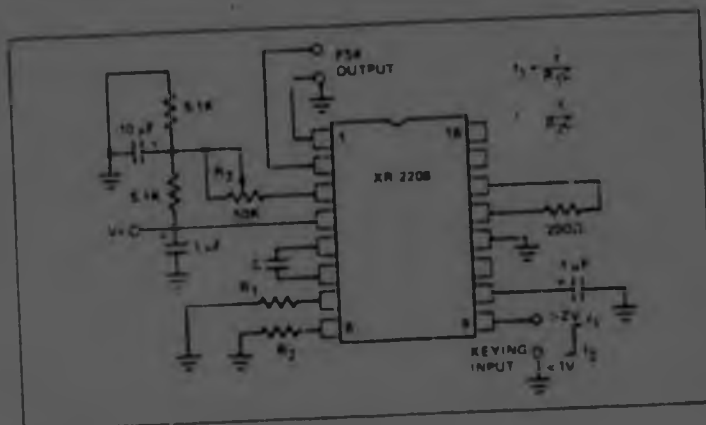

Figure 13. Sinusoidal FSK Generator

PULSE AND RAMP GENERATION

Figure 14 shows the circuit for pulse and ramp waveform generation. In this mode of operation, the FSK keying terminal (pin 9) is shorted to the square-wave output (pin 11); and the circuit automatically frequency-shift keys itself between two separate frequencies during the positive and negative going output waveforms. The pulse-width and the duty cycle can be adjusted from 1% to 99% by the choice of R_1 and R_2 . The values of R_1 and R_2 should be in the range of 1 K Ω to 2 M Ω .

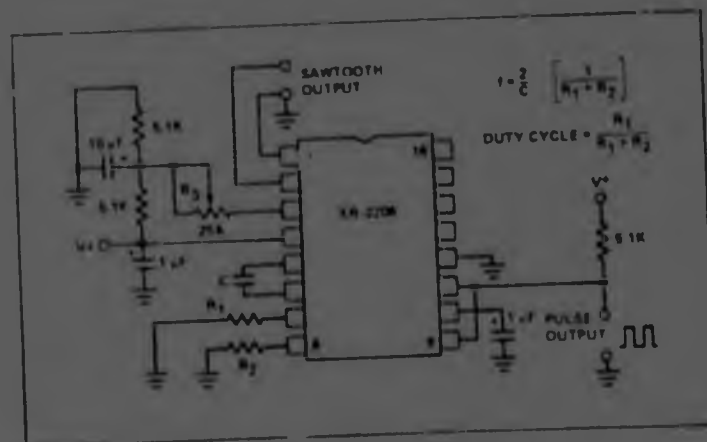

Figure 14. Circuit for Pulse and Ramp Generation

APPENDIX 3DESIGN RULES RELATED TO RELIABILITY

As seen in chapter 4, a number of aspects have a large bearing on the reliability of the system. Many other factors play a role, and whilst the solutions may often seem obvious, practice has proved that they are all too often neglected.

This appendix therefore covers the "rules of thumb" which have developed at the Chamber of Mines Research Organisation.

The humidity of 100% must not be taken too lightly, bearing in mind that there are many salts in the moisture. Moisture on printed circuit boards could lead to conduction between tracks where a voltage potential exists, whilst the increased conductivity could lead to changes in the value of components such as high value resistors. Many readily available components are not designed to resist ingress of moisture and their performance may be poorer in this high humidity, or at the extreme limit they may cease to function at all. These facts lead to careful attention to printed circuit board layouts coupled with a careful selection of components which provide the necessary moisture resistance (this generally means the use of "industrial" grade or "mil-spec" grade components).

Attention must also be paid to circuit details and particularly to high resistance values. As a general rule of thumb the use of resistors of a value greater than $470\text{ k}\Omega$ is avoided wherever possible. To improve moisture resistance, all printed circuit boards and components are coated with a conformal coating (Dow Corning) - mentioned earlier equipment enclosures should be sealed (preferably waterproof), but since this is nearly impossible (due to the high pressure underground and the fact that enclosures are sealed on surface) all the above-mentioned measures are necessary.

The corrosion resistance of all components is also improved by this coating. Gold plated contact materials have been found to be essential whilst in practice "plated-on" edge connectors have been found to be totally unsatisfactory. Even where the printed circuit board half of the connector is gold plated it is found that corrosion takes place underneath the gold. A conformal coating cannot be applied to the connector and therefore the only solution is to use "indirect" connectors such as eurocard type connectors conforming to DIN41612 and DIN41617. These have been found to provide a high

degree of reliability, and have been very successfully applied.

The need to withstand vibration is also important in some instances and in this regard all large components are strapped down. A good example of this type of component is a large board mounting electrolytic capacitor. The leads of these capacitors cannot be relied upon to support the capacitor and it has been found that the negative lead often breaks off. In general components which mount firmly on the printed circuit board are used wherever possible in preference to those that are free-standing and are supported by their leads.

As mentioned earlier the reliable and predictable operation of a system depends on its rejection of the noise sources present in the mines, particularly those present on the electrical supply. These noise sources, or any other possible noise sources should not cause an erroneous response. To further enhance fail safety, continuous transmission and reception of a signal should be a prerequisite for operation of any function remotely.

As mentioned already, to provide the necessary resistance to ingress of moisture, "hoseproof" enclosures were used. Wherever switches or connectors were mounted through the enclosure, Dow Corning Silastic Sealant was used to seal off the hole.

These are just some of the aspects which affect the reliability and fail safety of the system. It has been found that together with the aspects discussed in chapter 4, these are the most important factors to take into consideration.

APPENDIX 4

COMPARISON OF MODULATION TECHNIQUES

It has been shown that the various amplitude modulation schemes have the following signal-to-noise ratios.

$$\frac{S_o}{N_o} = \frac{S_i}{\eta_{fm}} \quad \text{for SSB - SC} \\ \text{(SSB suppressed carrier)}$$

$$\frac{S_o}{N_o} = \frac{S_i}{\eta_{fm}} \quad \text{for DSB - SC}$$

$$\frac{S_o}{N_o} = \frac{\overline{m^2(t)}}{1 + \overline{m^2(t)}} \frac{S_i}{\eta_{fm}} \quad \text{for DSB}$$

Similarly for frequency modulation

$$\frac{S_o}{N_o} = \frac{3}{2} \beta^2 \frac{S_i}{\eta_{fm}} \quad \text{for FM}$$

To make a comparison we must first simplify the equation for DSB. For modulation with a sinusoid

$$m(t) = m \cos 2\pi f_m t$$

thus giving $\overline{m^2(t)} = m^2/2$

$$\frac{S_o}{N_o} = \frac{m^2}{2 + m^2} \frac{S_i}{\eta_{fm}} \quad \text{for DSB}$$

Comparing FM with SSB we can determine where FM becomes superior. This is given for β greater than the value obtained below

$$1 = \frac{3}{2} \beta^2$$

$$\beta = \sqrt{\frac{2}{3}} = \underline{0.82}$$

Similarly, comparing FM with DSB (assuming $m = 1$, i.e. 100% modulation)

$$\frac{m^2}{2 + m^2} = \frac{3}{2} \beta^2$$

$$\frac{1}{2 + 1} = \frac{3}{2} \beta^2$$

$$\beta = \sqrt{\frac{2}{9}} = 0,47$$

Thus we see that as the modulation index (β) is increased (i.e. the bandwidth is increased) the signal to noise ratio improves.

Another factor to be considered is the threshold. DSB-SC and SSB do not exhibit a threshold whereas FM and DSB do. Since DSB-SC and SSB are better than DSB, only SSB (DSB-SC is the same) will be compared with FM.

The equation given earlier for FM signal-to-noise ratio applies above the threshold. The general equation is

$$\frac{S_s}{N_o} = \frac{(\frac{3}{2}) \beta^2 (S_i / \pi f_m)}{1 + (12\beta/\pi) (S_i / \pi f_m) \exp\{-\frac{1}{2} [1/\beta + 1] (S_i / \pi f_m)\}}$$

This equation is plotted for various β and compared to the equation for SSB (see figure A4.1.)

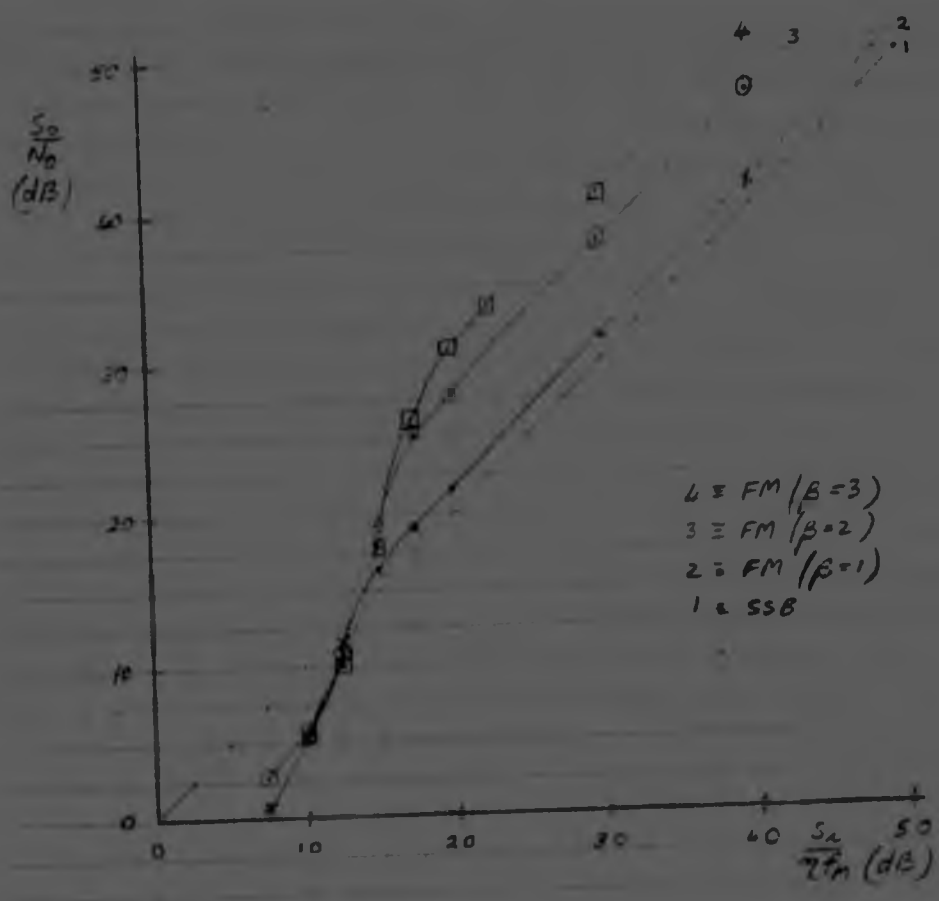

Output SNR of FM compared with SSB
Figure A 4.1.

---o0o---

APPENDIX 5CIRCUIT DIAGRAMS FOR MONORAIL CONTROL SYSTEM

Figures A5.1. to A5.5. show the circuit diagrams of the monorail control system. The actual interconnections between receiver modules have not been shown as they are not relevant here.

APPENDIX 5CIRCUIT DIAGRAMS FOR MONORAIL CONTROL SYSTEM

Figures A5.1. to A5.5. show the circuit diagrams of the monorail control system. The actual interconnections between receiver modules have not been shown as they are not relevant here.

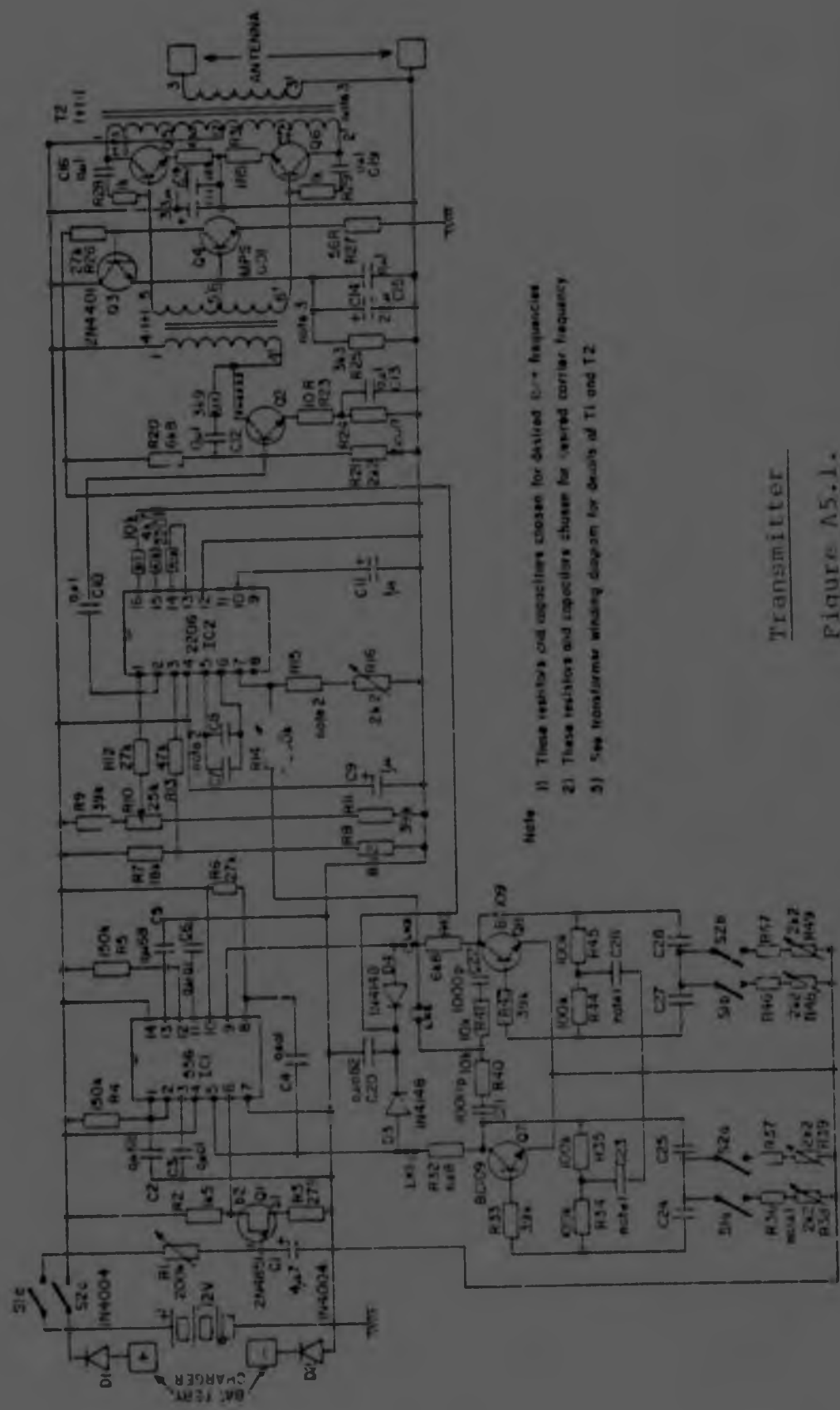

- Note
- 1) These resistors and capacitors chosen for desired 1000 frequencies
 - 2) These resistors and capacitors chosen for desired carrier frequency
 - 3) See transformer winding diagram for details of T1 and T2

Transmitter
Figure A5.1.

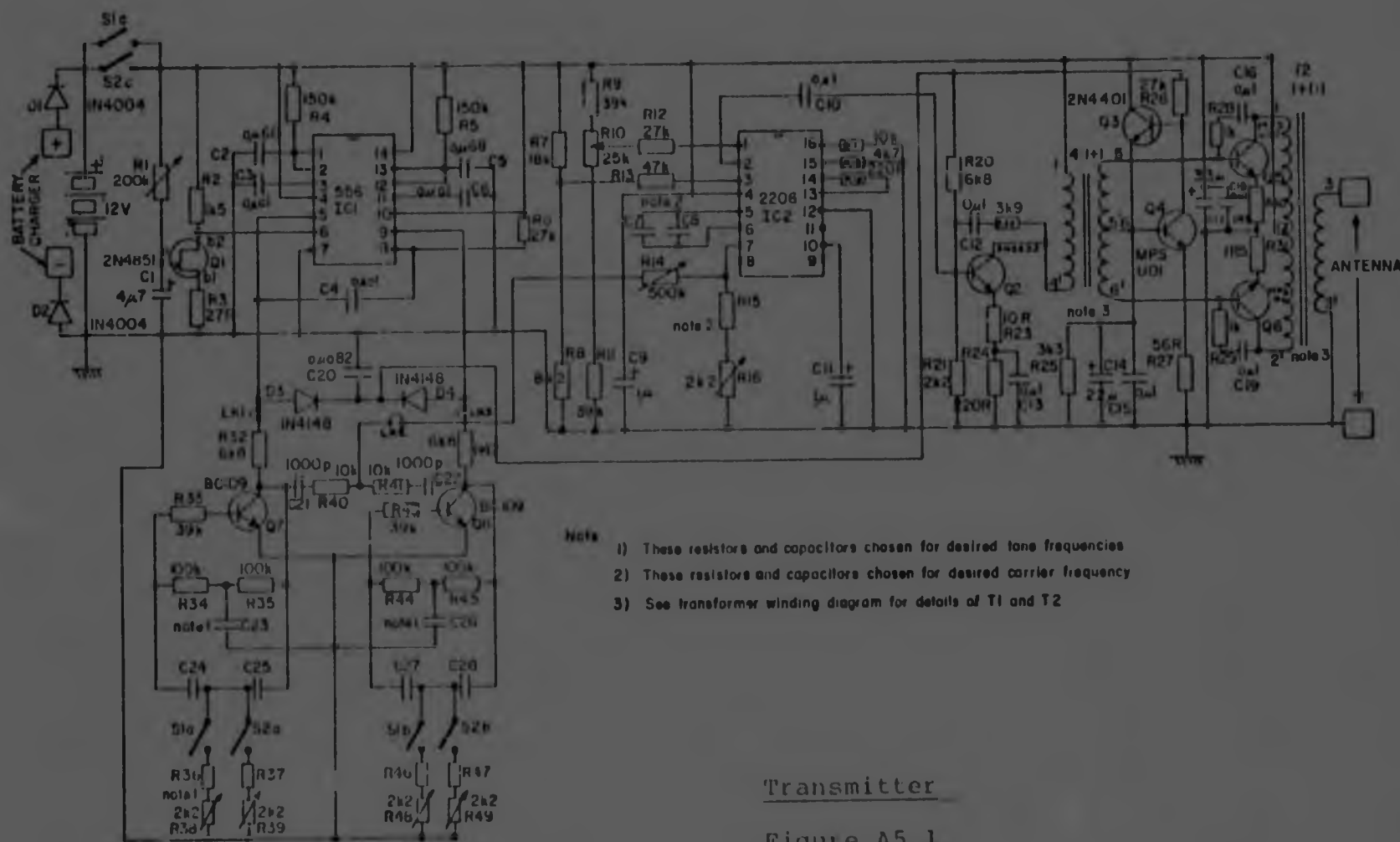

Transmitter

Figure A5.1.

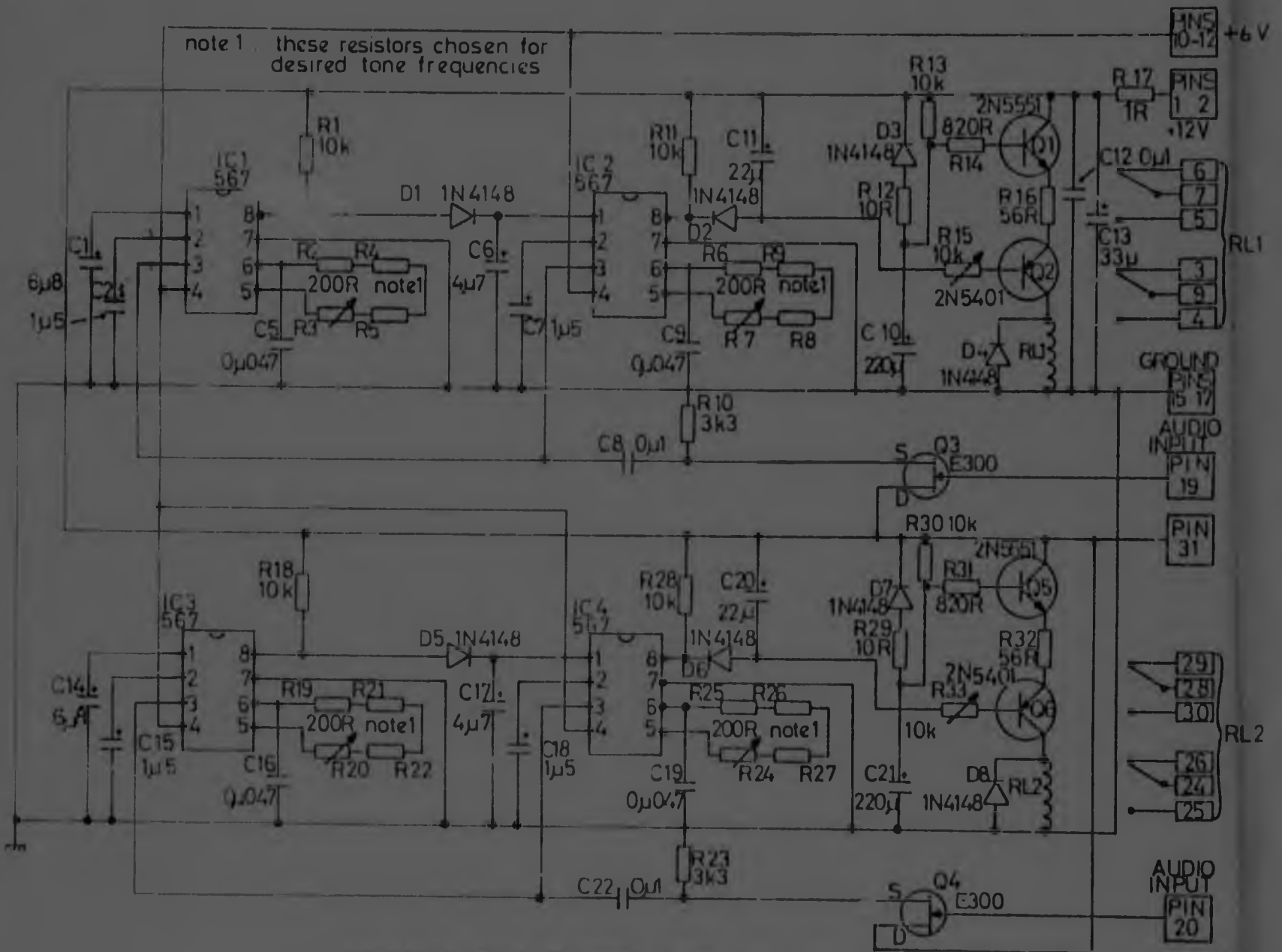

Receiver Dual Channel Tone Decoder
 Figure A5.4.

APPENDIX 6CIRCUIT DIAGRAMS FOR IMPACT RIPPER CONTROL SYSTEM

Figures A6.1. to A6.14 show the circuit diagrams for the impact ripper control system. The actual interconnections between receiver modules have not been shown as they are not relevant here.

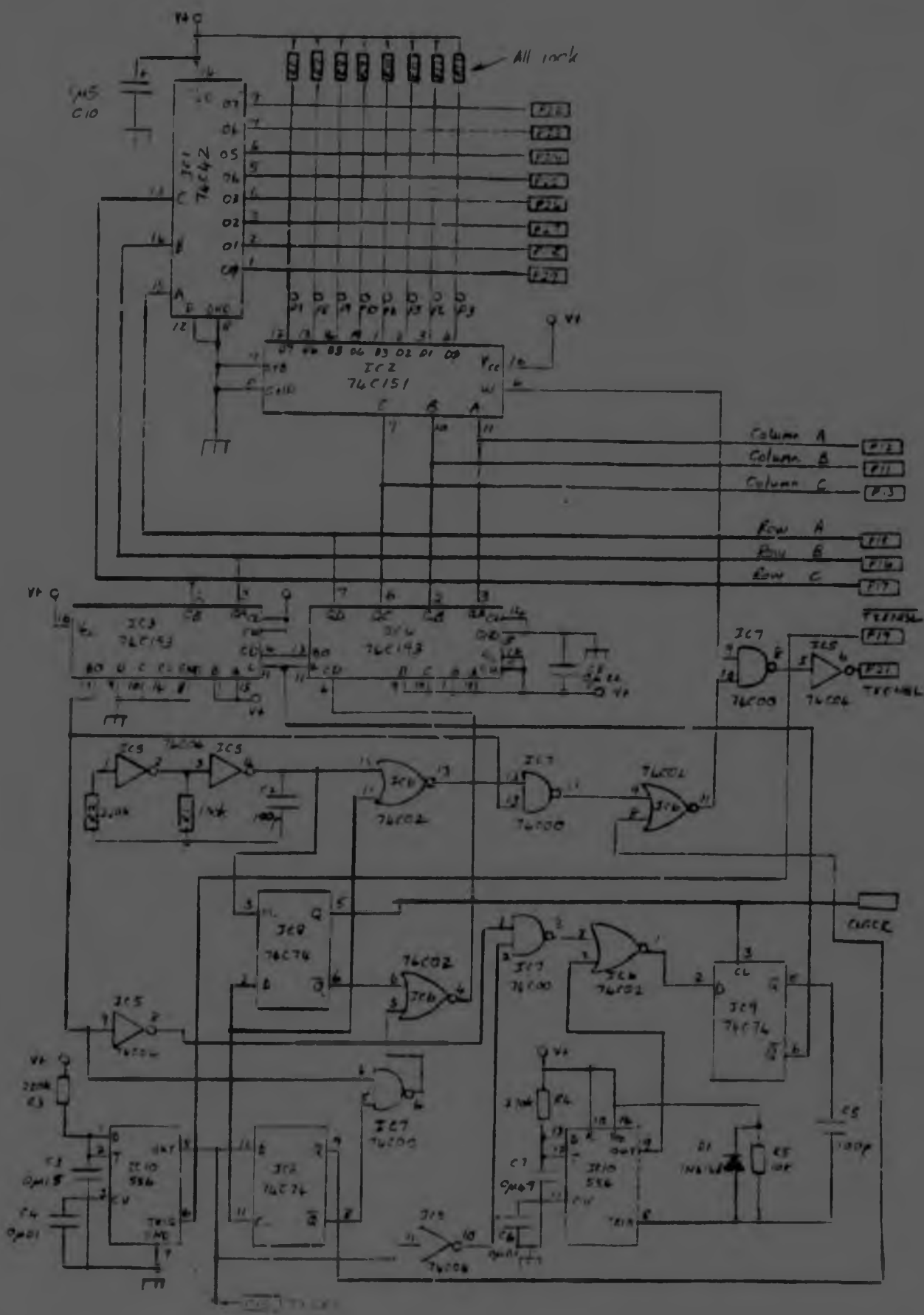

Transmitter Keyboard Encoder

Figure A6.1.

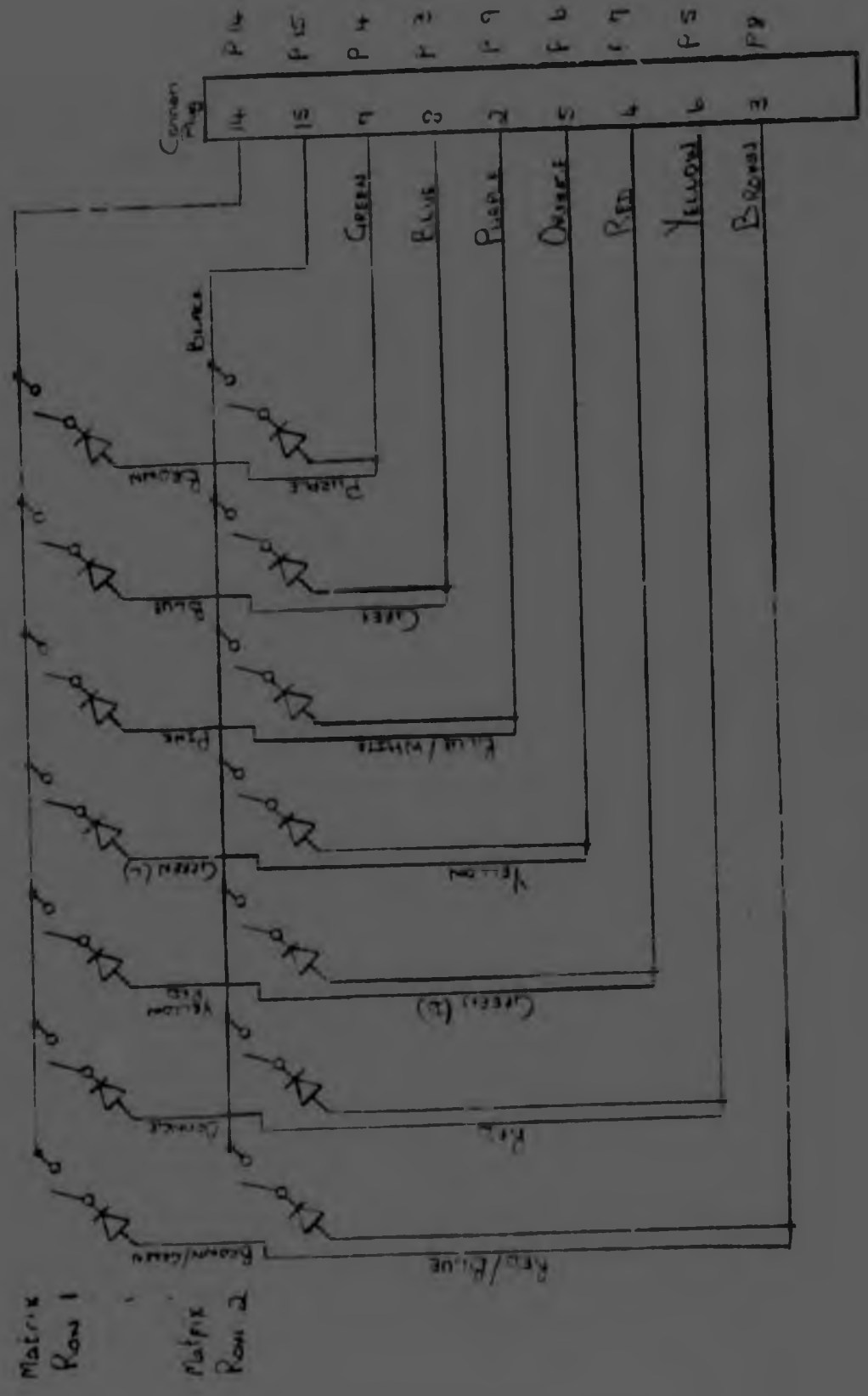

Transmitter Control Switch Wiring

Figure A6.2.

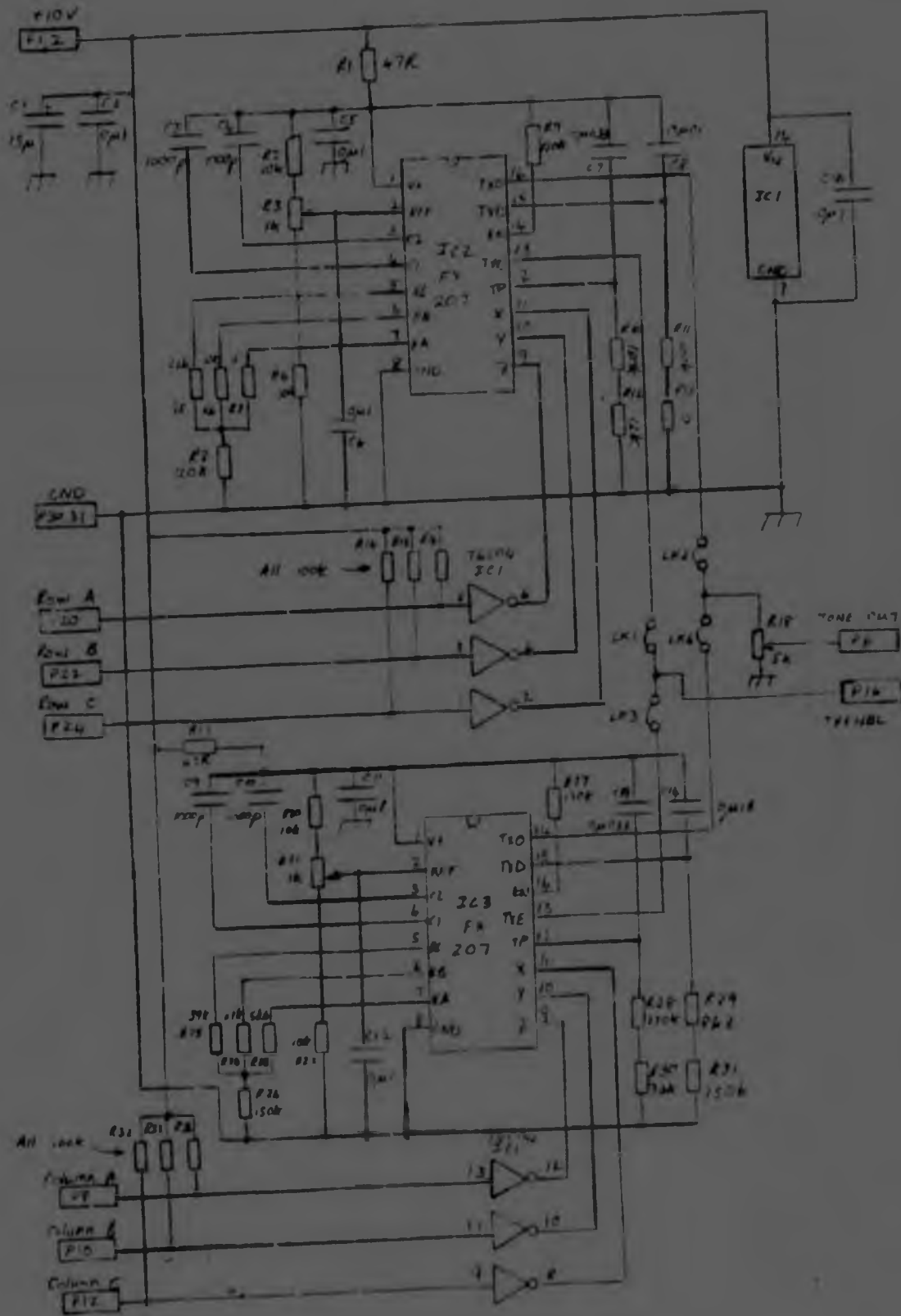

Transmitter Tone Encoder

Figure A6.3.

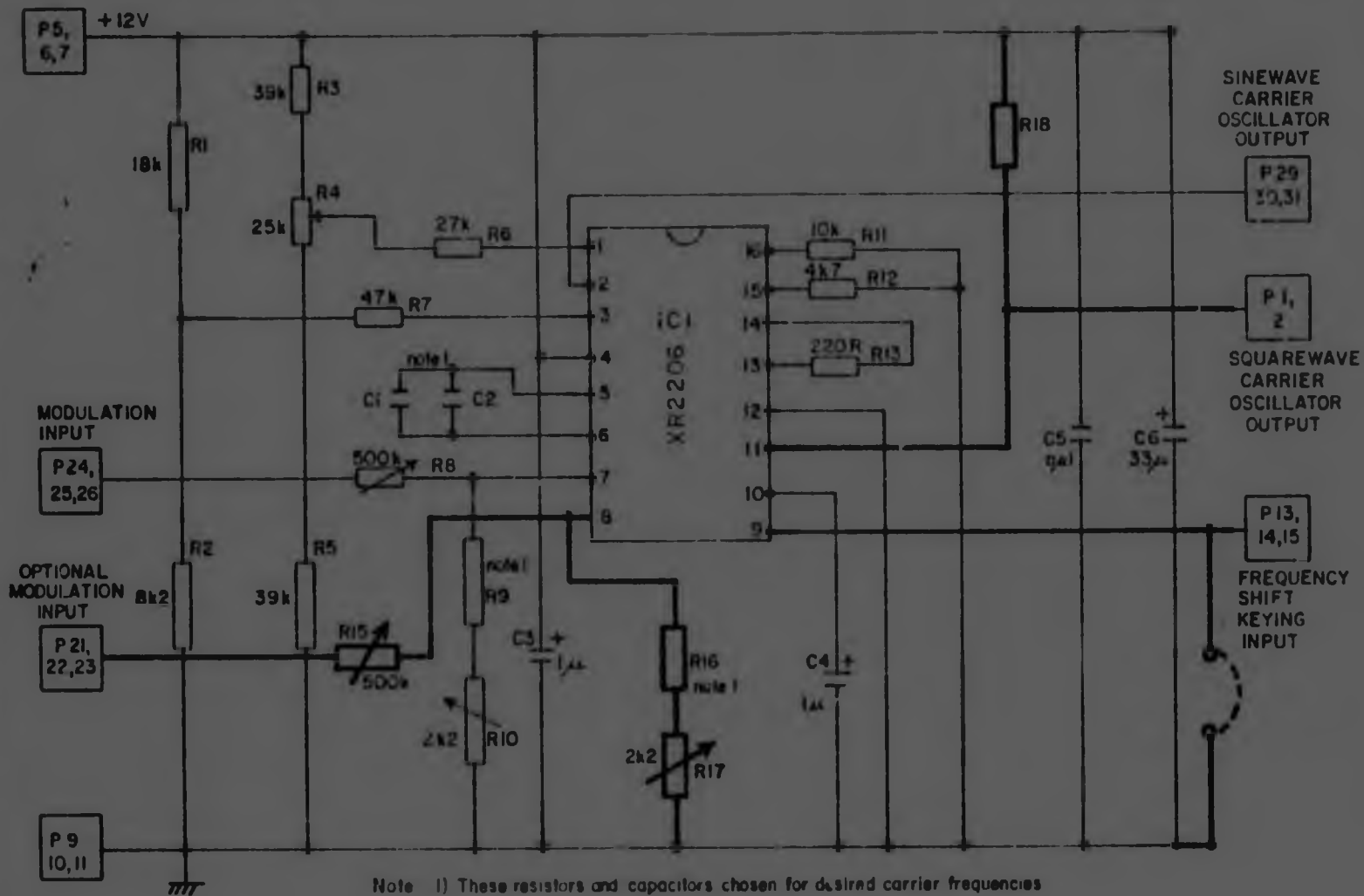

Note 1) These resistors and capacitors chosen for desired carrier frequencies
 2) Heavy line components are optional and increase flexibility of module

Transmitter Carrier Oscillator

Figure AG.4.

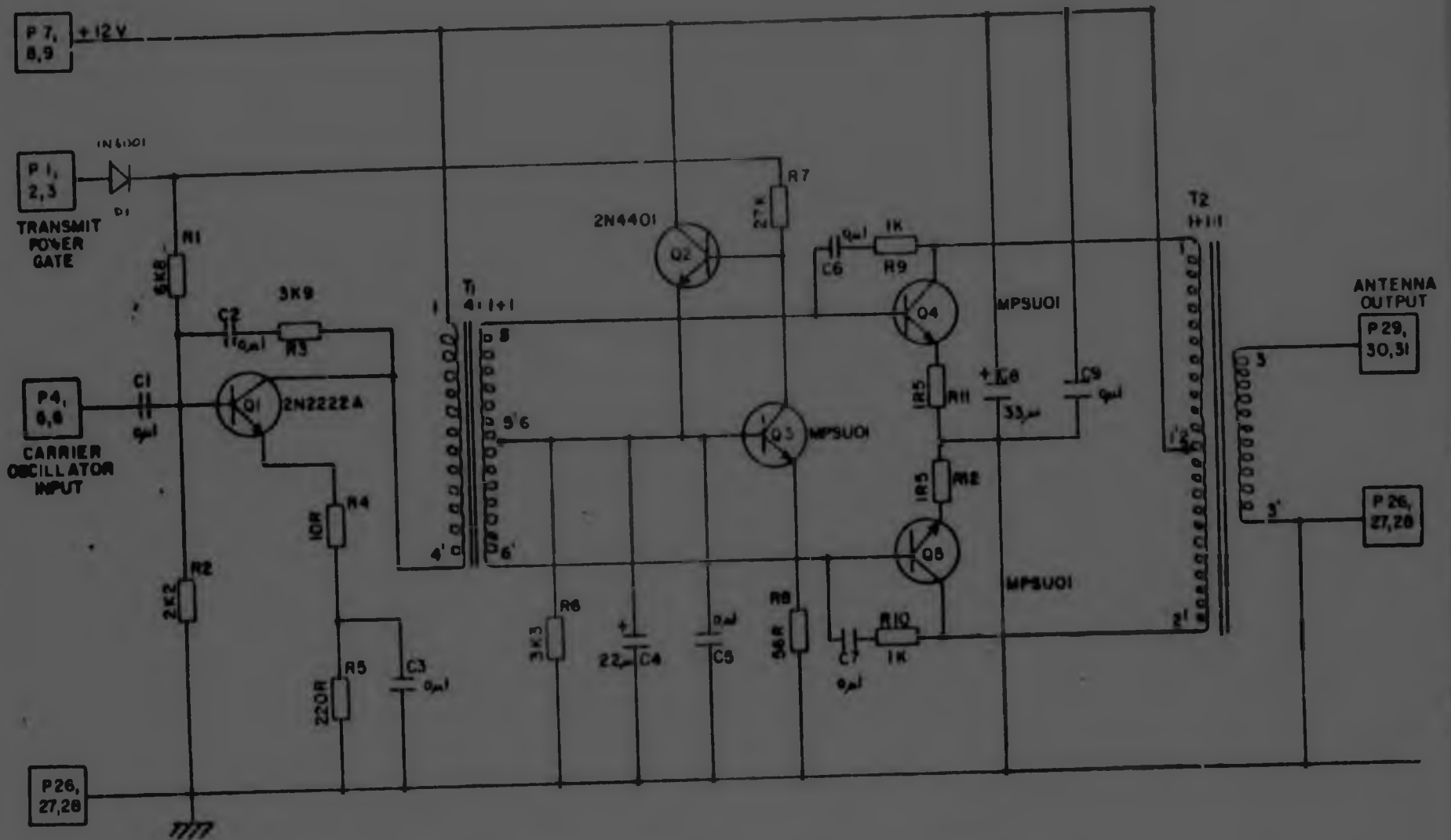

Transmitter Power Amplifier

Figure A6.5.

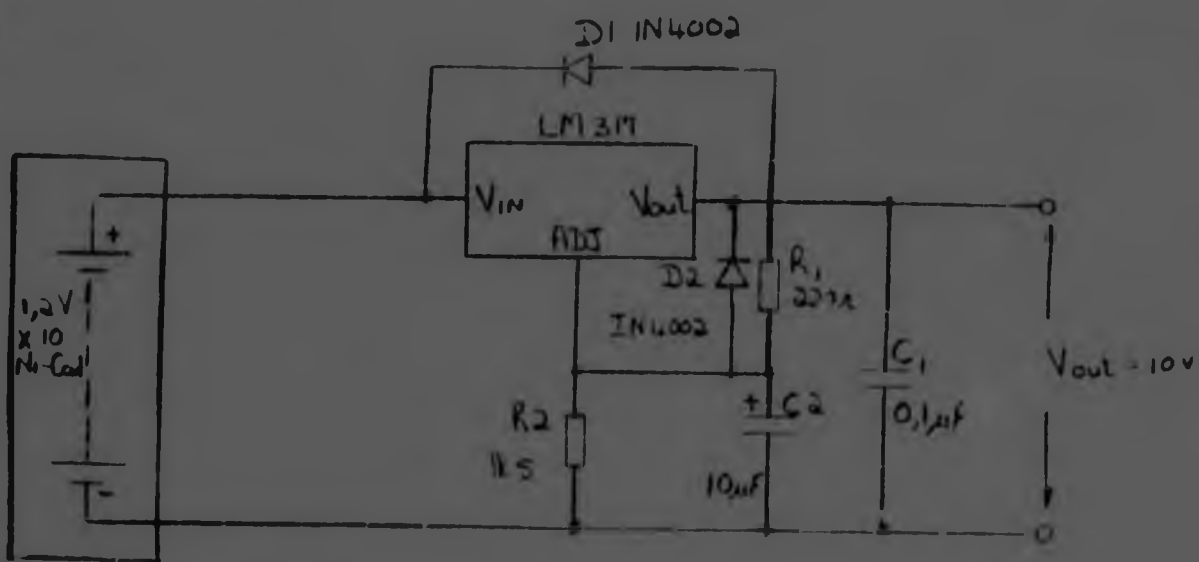

Transmitter Voltage Regulator

Figure A6.6.

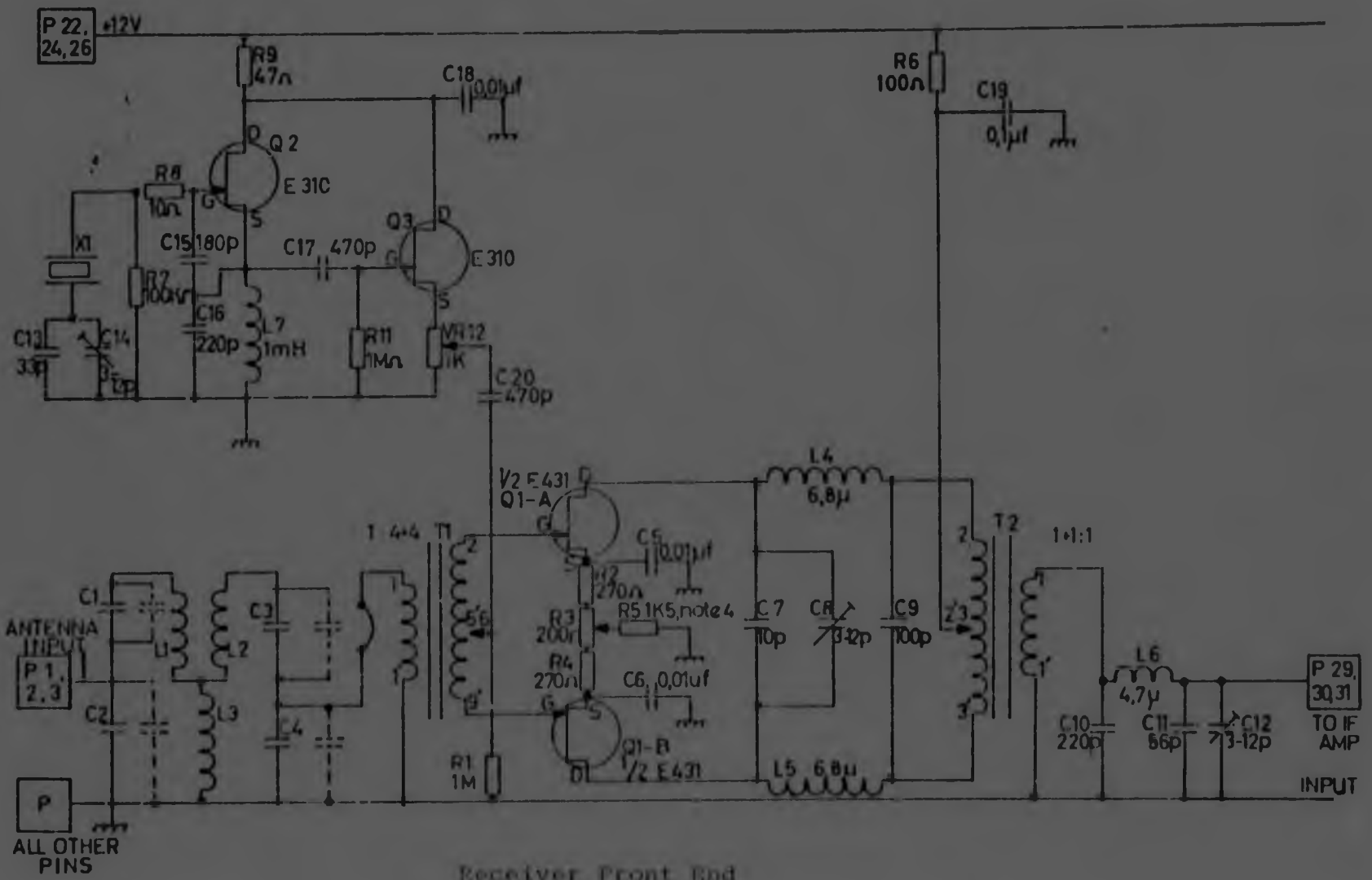

Receiver Front End

Figure A6.7.

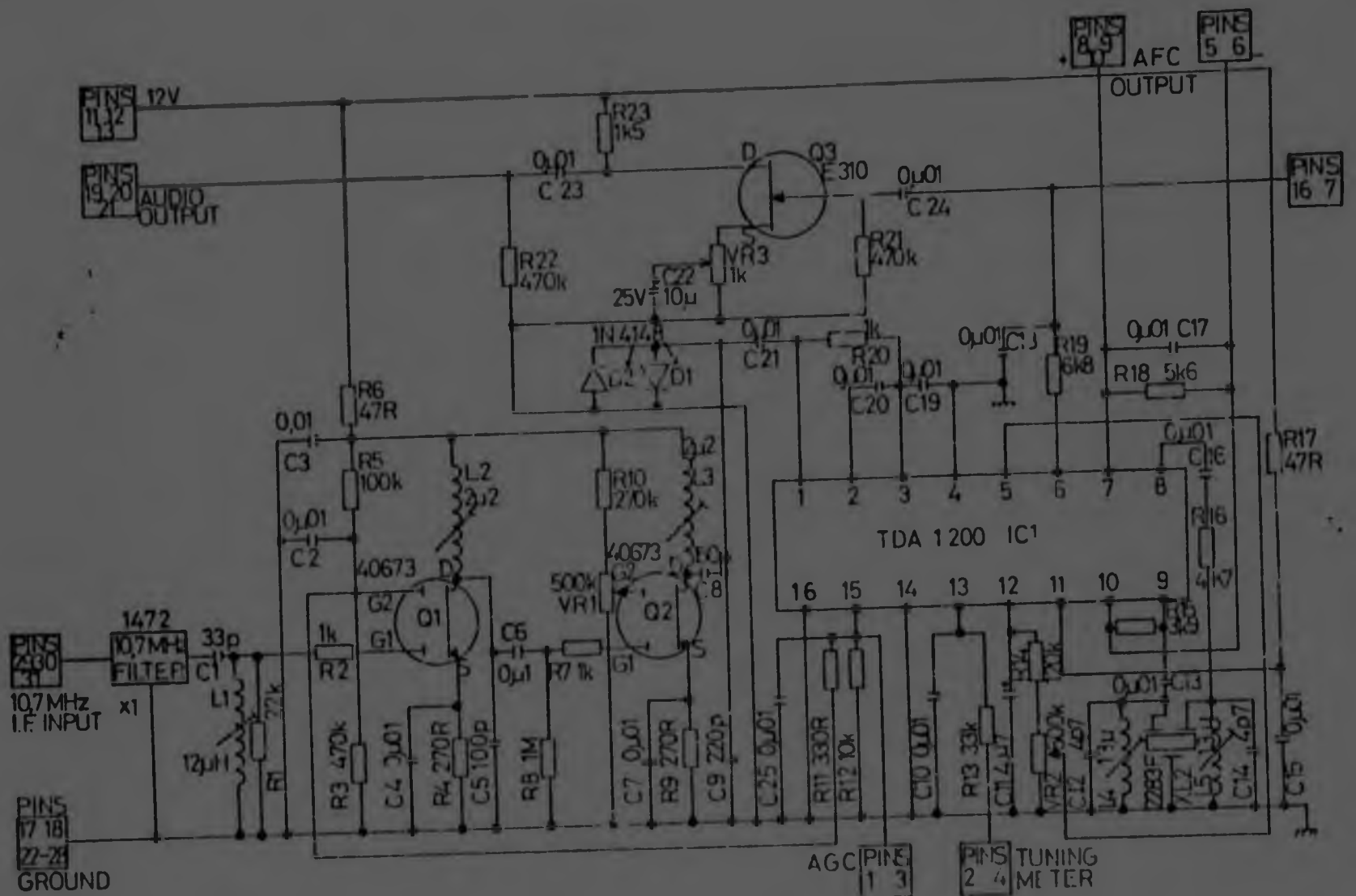

Receiver Intermediate Frequency Amplifier
and FM Demodulator
Figure A6.8.

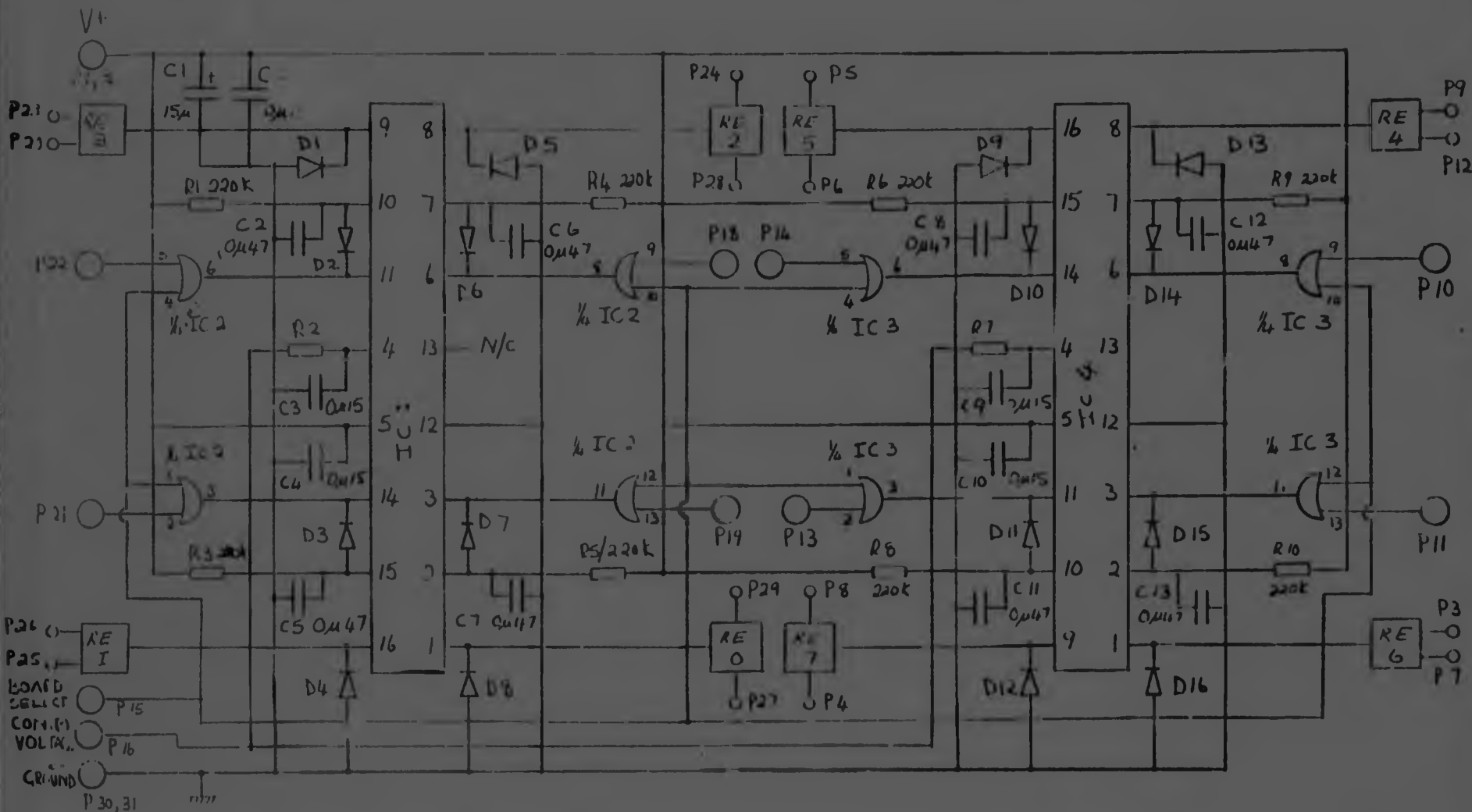

Receiver Relay Driver

Figure A6.10

- IC 1 & 4 = NE 559
- IC 2 & 3 = 74C32
- D1 to D16 = 1N4148

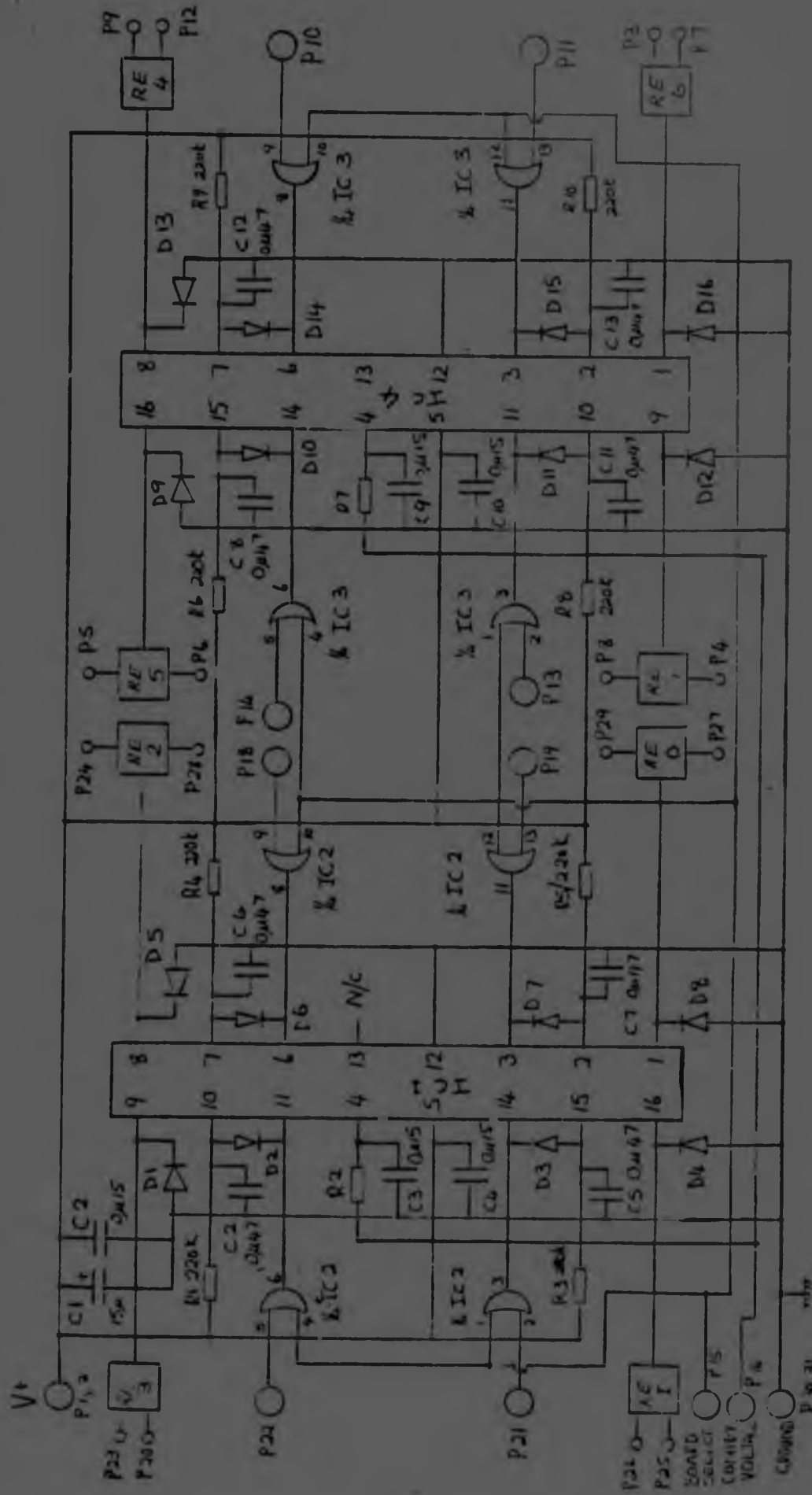

Receiver Relay Driver

Figure A6.10

IC 1 & 4 = NE 559

IC 2 & 3 = 74C32

D1 to D16 = IN4148

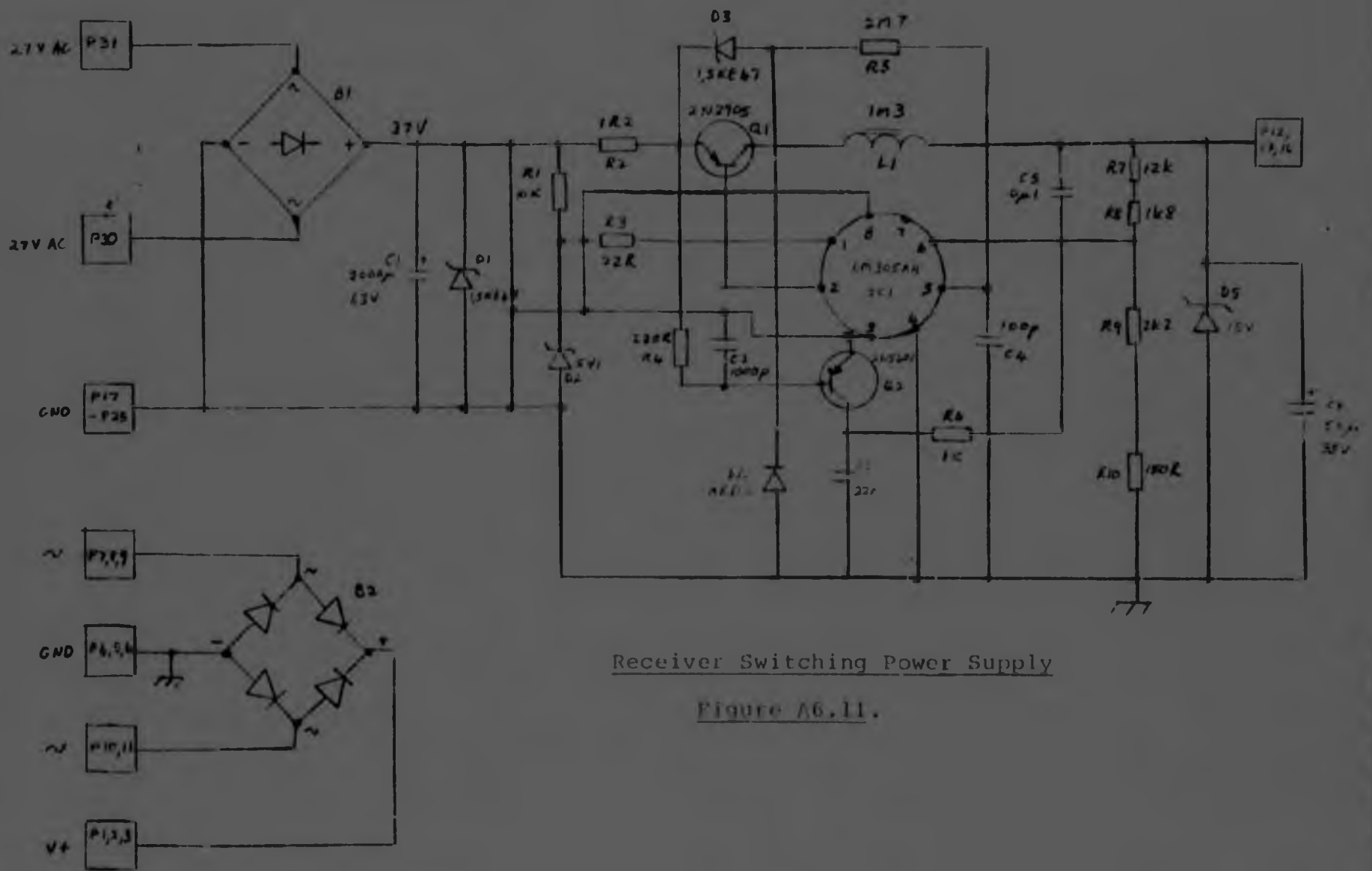

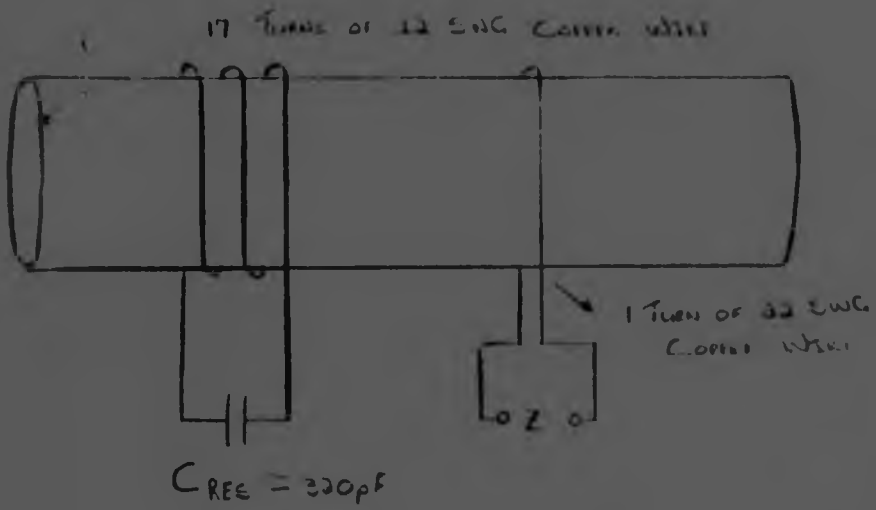

Receiver Antenna

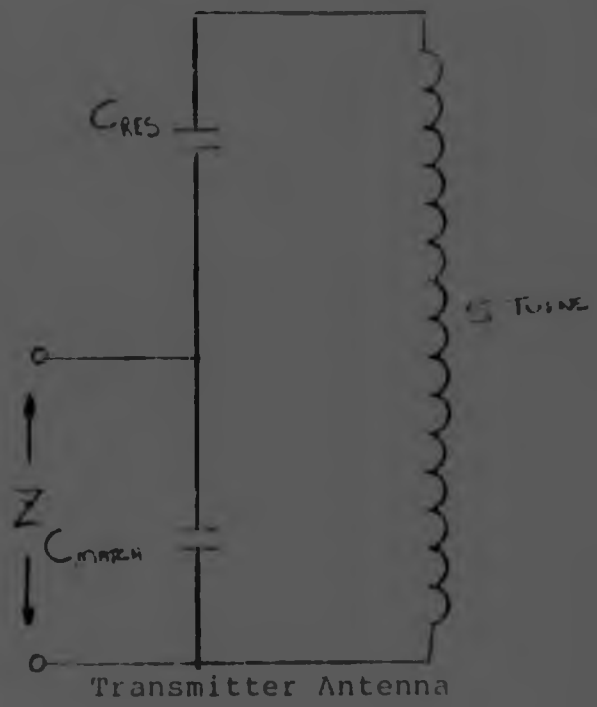

Transmitter and Receiver Antennas

Figure A6.12

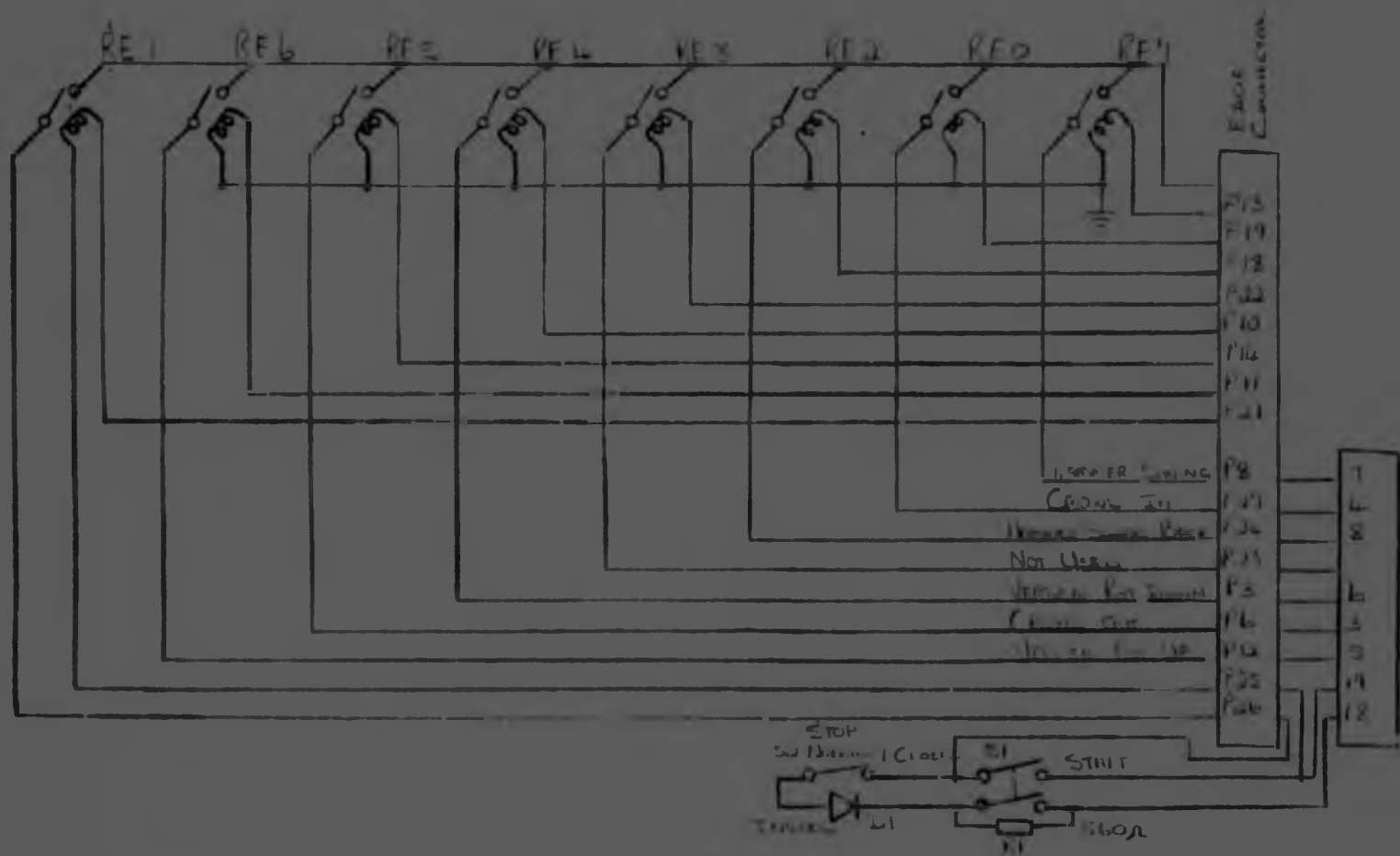

Receiver Relay Wiring

Figure A6.13

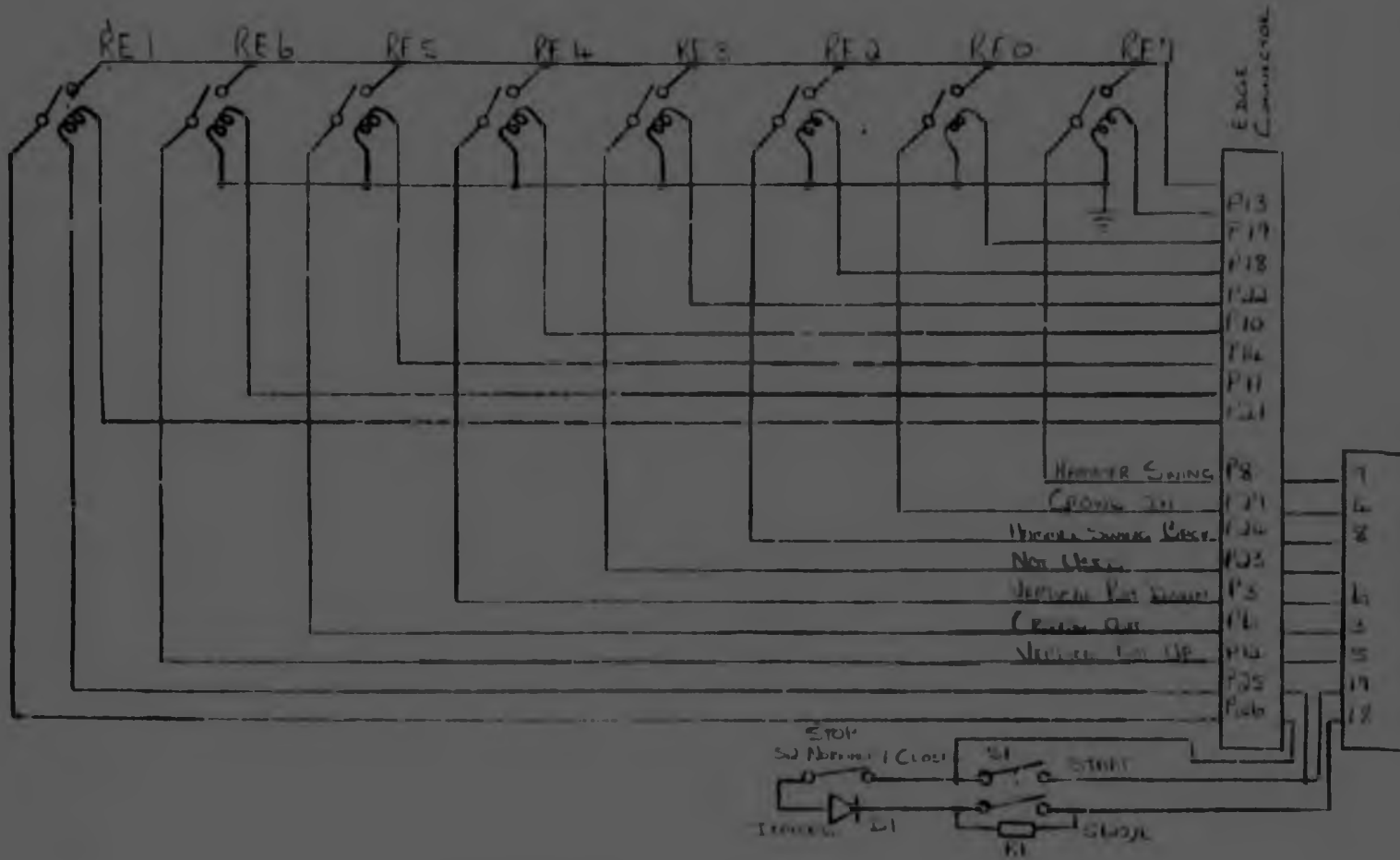

Receiver Relay Wiring

Figure A6.13

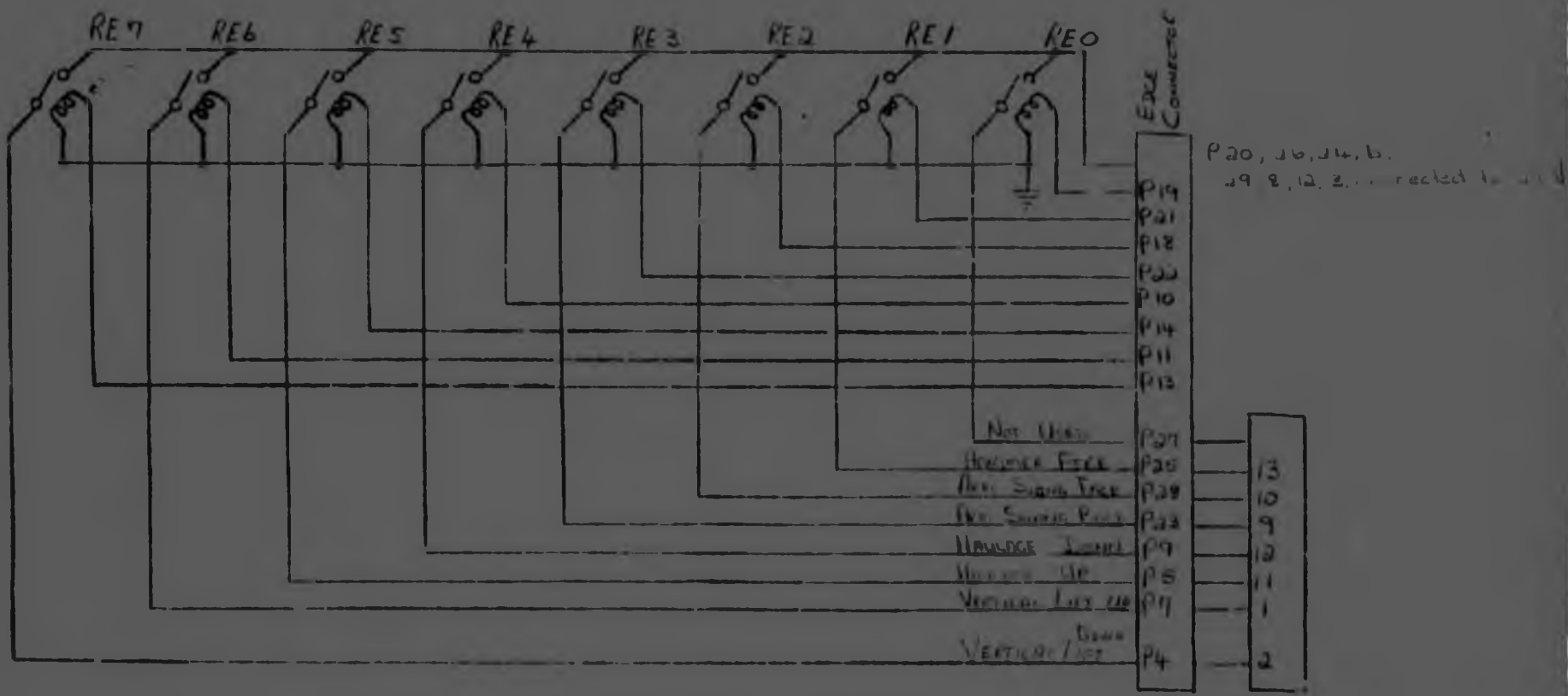

Receiver Relay Wiring
 Figure A6.14

APPENDIX 7

OTHER RELATED DATA SHEETS



Industrial/Automotive/Functional
Blocks/Telecommunications

LM556/LM556C Dual Timer

General Description

The LM556 Dual timing circuit is a highly stable controller capable of producing accurate time delays or oscillation. The 556 is a dual 555. Timing is provided by an external resistor and capacitor for each timing function. The two timers operate independently of each other sharing only V_{CC} and ground. The circuits may be triggered and reset on falling waveforms. The output structures may sink or source 200 mA.

- Adjustable duty cycle
- Output can source or sink 200 mA
- Output and supply TTL compatible
- Temperature stability better than 0.005% per °C
- Normally on and normally off output

Features

- Direct replacement for SE556/NE556
- Timing from microseconds through hours
- Operates in both astable and monostable modes
- Replaces two 555 timers

Applications

- Precision timing
- Pulse generation
- Sequential timing
- Time delay generation
- Pulse width modulation
- Pulse position modulation
- Linear ramp generator

Schematic Diagram

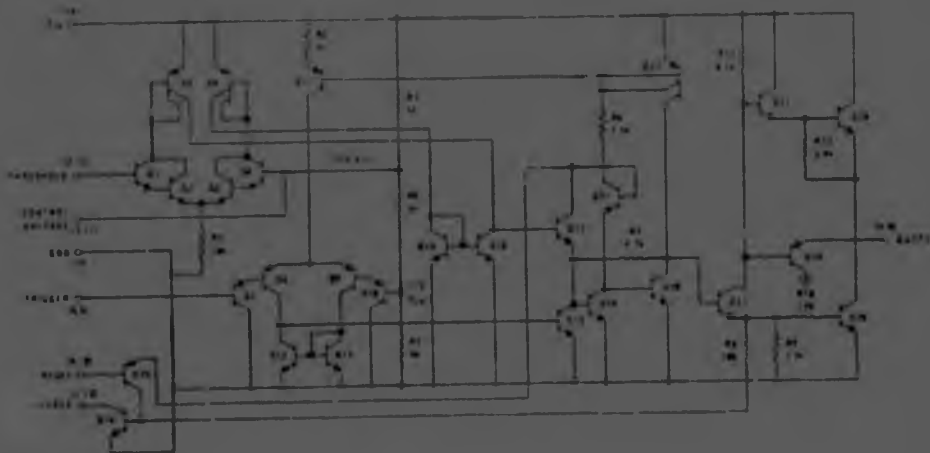

Connection Diagram

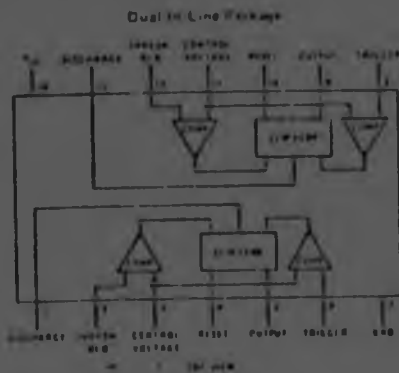

Order Number LM556CN
See NS Package N14A

Order Number LM556CJ or LM556CJ
See NS Package J14A

LM556/LM556C

Absolute Maximum Ratings

Supply Voltage	+18V
Power Dissipation (Note 1)	600 mW
Operating Temperature Ranges	
LM556C	0°C to +70°C
LM556	-55°C to +125°C
Storage Temperature Range	-65°C to +150°C
Lead Temperature (Soldering 10 seconds)	300°C

Electrical Characteristics ($T_A = 25^\circ\text{C}$, $V_{CC} = +5\text{V}$ to $+15\text{V}$, unless otherwise specified)

PARAMETER	CONDITIONS	LM556			LM556C			UNITS
		MIN	TYP	MAX	MIN	TYP	MAX	
Supply Voltage		4.5		18	4.5		18	V
Supply Current (Note 1)	$V_{CC} = 5\text{V}$, $I_O = 0\text{mA}$ $V_{CC} = 15\text{V}$, $I_O = 0\text{mA}$ (Illum State) (Note 2)		3	5		3	5	mA
Timing Error - Monostable			0.5	1%		0.75	1%	%
Initial Accuracy			30			60		ppm/°C
Drift With Temperature	$R_{th} = R_{th}^* \times 10$, $C = 0.1\mu\text{F}$ (Note 3)		1.5	5		1.5	5	%/°C
Accuracy Over Temperature			0.05	0.2		0.1	0.4	%/V
Drift With Supply								%/V
Timing Error - Astable			5.5			3.75	7	%
Initial Accuracy			90			180		ppm/°C
Drift With Temperature			2.5			3.0		%/°C
Accuracy Over Temperature			0.15	0.7		0.20		%/V
Drift With Supply								%/V
I_{OH} - Voltage	$V_{CC} = 15\text{V}$ $V_{OL} = 5\text{V}$	4.5	5	5.2	4.5	5	5.5	V
I_{OH} - Current		1.50		1.5	1.25		1.67	mA
Load Voltage	(Note 4)	0.1		0.4		0.1	0.6	mA
Ampl. Current			0.03	0.1		0.03	0.1	mA
Threshold Current	(Note 5)							mA
Control Voltage Level - And	$V_{OL} = 15\text{V}$	8.5	10	10.4	9	10	11	V
Threshold Voltage	$V_{OL} = 15\text{V}$	8.7	3.33	3.8	2.8	3.33	3.8	V
Short-Circuit Output High			1	100		1	100	mA
Fall Time	(Note 6)		150	340		180	380	nV
Output Low	$V_{CC} = 15\text{V}$, $I_O = 15\text{mA}$		70	100		80	110	nV
Output Low	$V_{CC} = 5\text{V}$, $I_O = 4.5\text{mA}$							nV
Output Voltage Drop (Low)	$V_{CC} = 15\text{V}$ $I_{OL} = 10\text{mA}$ $I_{OL} = 50\text{mA}$ $I_{OL} = 100\text{mA}$ $I_{OL} = 200\text{mA}$ $V_{CC} = 5\text{V}$ $I_{OL} = 8\text{mA}$ $I_{OL} = 6\text{mA}$		0.1	0.15		0.1	0.25	V
			0.4	0.5		0.4	0.75	V
			2	2.75		2	2.75	V
			2.5			2.5		V
			0.1	0.25		0.25	0.25	V
Output Voltage Drop (High)	$I_{OH} = 200\text{mA}$, $V_{CC} = 15\text{V}$ $I_{OH} = 100\text{mA}$, $V_{CC} = 15\text{V}$ $V_{CC} = 5\text{V}$		12.5			12.5		V
			12.3			12.3		V
			3			3		V
Rise Time of Output			100			100		nV
Fall Time of Output			100			100		nV
Matching Characteristics	(Note 7)							%
Initial Timing Accuracy			0.05	0.1		0.1	0.2	%
Timing Drift With Temperature			0.10			0.10		ppm/°C
Drift With Supply Voltage			0.1	0.2		0.2	0.5	%/V

Note 1: For operating at elevated temperatures, the device must be derated based on a +150°C maximum junction temperature and a thermal resistance of +150°C/W junction to ambient for both packages.
 Note 2: Supply current when output high typically 1 mA less at $V_{CC} = 5\text{V}$.
 Note 3: Tested at $V_{CC} = 5\text{V}$ and $V_{CC} = 15\text{V}$.
 Note 4: At zero voltage loads, timing is maximum and then the output goes low.
 Note 5: This will determine the maximum value of $R_A + R_B$ for 15V operation. The maximum total $(R_A + R_B)$ is 20 MΩ.
 Note 6: No provision against excessive pin 3, 12 current is necessary provided the package dissipation rating will not be exceeded.
 Note 7: Matching characteristics refer to the difference between performance and overall of each time 1000.

LM556/LM556C

Typical Performance Characteristics

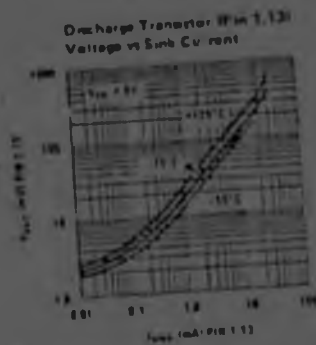
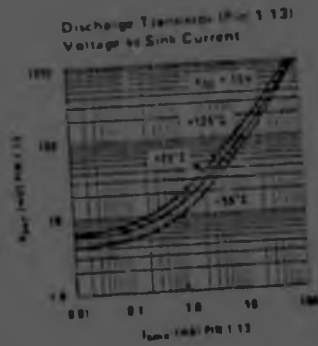
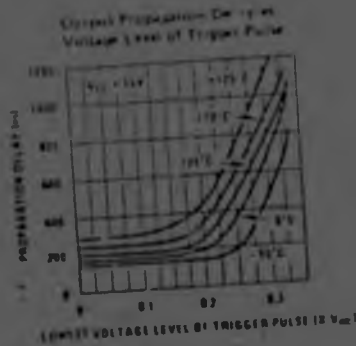
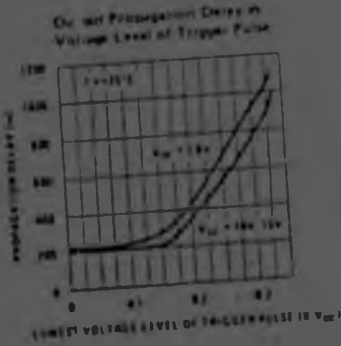
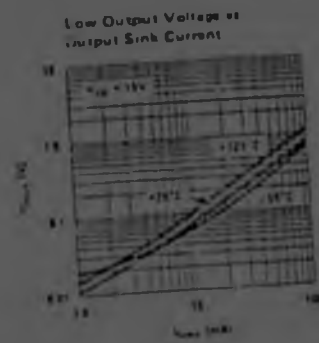
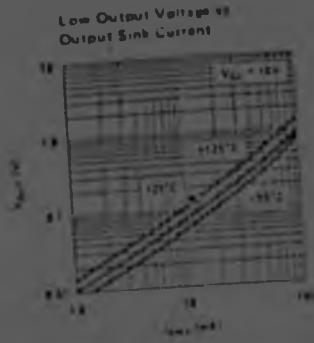
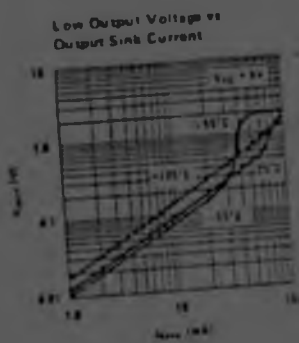
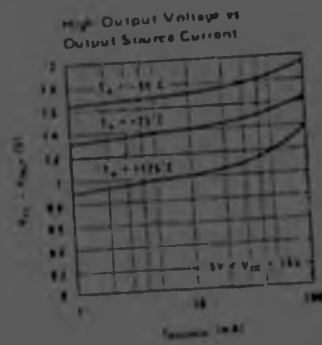
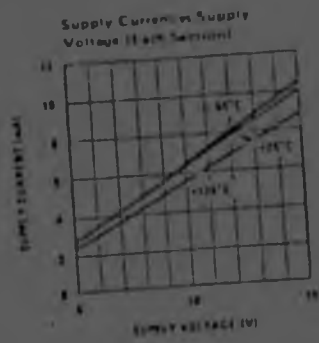
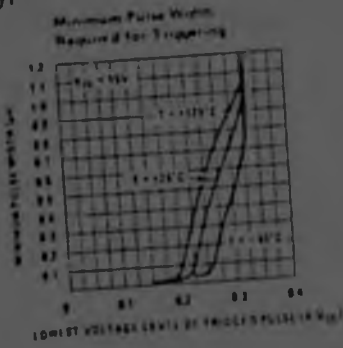

LM3089

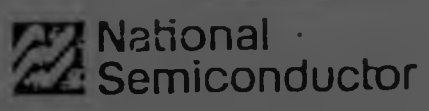

Audio, Radio and TV Circuits

LM3089 FM Receiver IF System

General Description

The LM3089 has been designed to provide all the major functions required for modern FM IF designs of automotive, high fidelity and communications receivers.

Features

- Three stage IF amplifier/limiter provides 12 μ V (typ) -3 dB limiting sensitivity
- Balanced product detector and audio amplifier provide 400 mV (typ) of recovered audio with distortion as low as 0.1% with proper external coil designs

- Four internal carrier level detectors provide delayed AGC signal to tuner, IF level meter drive current and interchannel mute control
- AFC amplifier provides AFC current for tuner and/or center tuning meters
- Improved operating and temperature performance, especially when using high Q quadrature coils in narrow band FM communications receivers
- No mute circuit latchup problems
- A direct replacement for CA3089E

Block and Connection Diagram

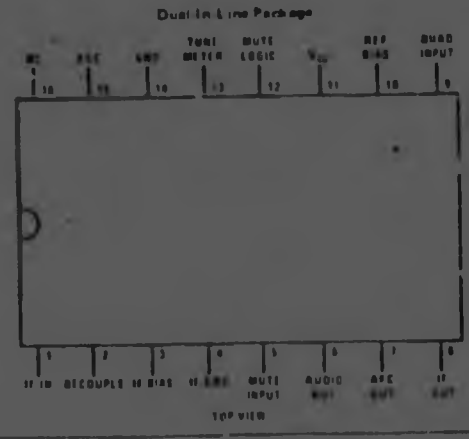
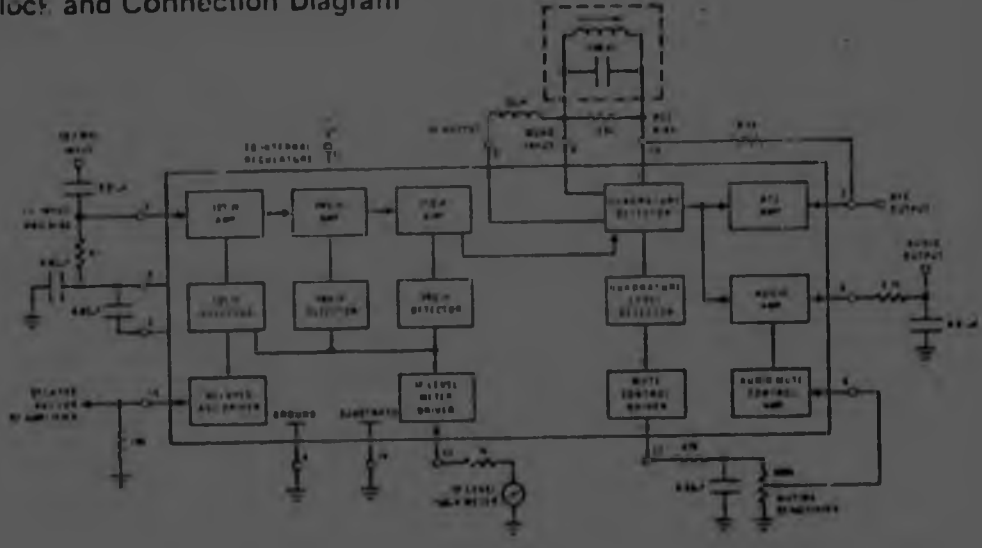

Order Number LM3089N
See NS Package N18F

LM3089

Absolute Maximum Ratings

Voltage Between Pins 1 and Pin 4 - 14	+16V	Power Dissipation (Note 2)	1290 mW
DC Current Out of Pin 12	5 mA	Operating Temperature Range	40°C to +85°C
DC Current Out of Pin 13	5 mA	Storage Temperature Range	-65°C to +150°C
DC Current Out of Pin 15	5 mA	Lead Temperature (Soldering)	300°C

Electrical Characteristics (I_A = 25°C, V_{CC} = +12V, see Test Load 1)

PARAMETER	CONDITIONS	MIN	TYP	MAX	UNITS	
DC CHARACTERISTICS (V_{IN} = 0, NOT MUTED)						
I ₁₁	Supply Current	16	23	30	mA	
V _{1, 2, 3}	IF Input and Bias	1.2	1.9	2.4	V	
V ₆	Audio Output	5.0	5.6	6.0	V	
V ₇	AFC Output	5.0	5.6	6.0	V	
V ₁₀	Reference Bias	5.0	5.6	6.0	V	
V ₁₂	Mute Control	0	0.5	0.5	V	
V ₁₃	IF Level	4.2	4.7	5.3	V	
V ₁₅	Delayed AGC					
DYNAMIC CHARACTERISTICS (f₀ = 10.7 MHz, Δf = 275 kHz @ 400 Hz)						
V _{IN} (LIM)	Input Limiting - 3 dB		12	25	μV	
AMR	AM Rejection	V _{IN} = 100 mV, AM = 30%	45	55	-dB	
V _Q (AF)	Recovered Audio	V _{IN} = 10 mV	300	400	500 mVrms	
THD	Total Harmonic Distortion				%	
	Single Tuned (Note 1)	V _{IN} = 100 mV		0.5	1.0	
	Doubly Tuned (Note 1)	V _{IN} = 100 mV		0.1	0.3	
S+N/N	Signal to Noise Ratio	V _{IN} = 100 mV	60	70	dB	
V ₁₂	Mute Control	V _{IN} = 100 mV	0	0.5	V	
V ₁₃	IF Level	V _{IN} = 100 mV	4.0	5.0	6.0	V
V ₁₃	IF Level	V _{IN} = 500 μV	1.0	1.5	2.0	V
V ₁₅	Delayed AGC	V _{IN} = 100 mV		0.1	0.5	V
V ₁₅	Delayed AGC	V _{IN} = 30 mV		2.5	2.5	V
V _Q (AF)	Audio Muted	V _{IN} = 100 mV, V ₅ = +2.5V		60		-dB

Note 1: Distortion is a function of quadrature gain.
 Note 2: For operation in ambient temperatures above 25°C, the device must be derated based on a 150°C maximum junction temperature and a thermal resistance of 90°C/W junction to ambient.

Typical Performance Characteristics

Typical S+N/N and IF Limiting Sensitivity vs IF Input Signal

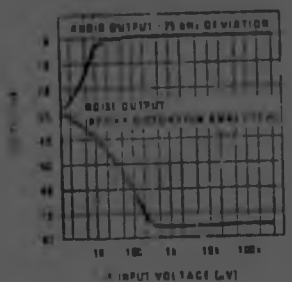

Typical AGC (Pin 15) and Meter Output (Pin 13) vs IF Input Signal

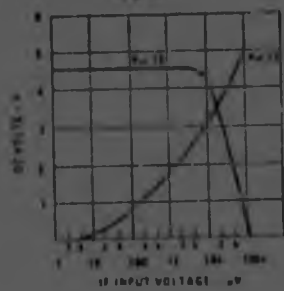

AM Rejection (30% Mod) vs IF Input Signal

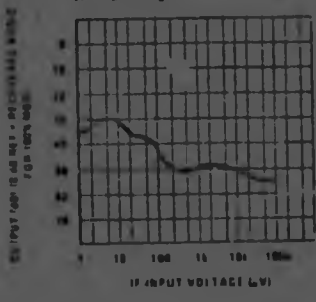

LM3089

Schematic Diagram

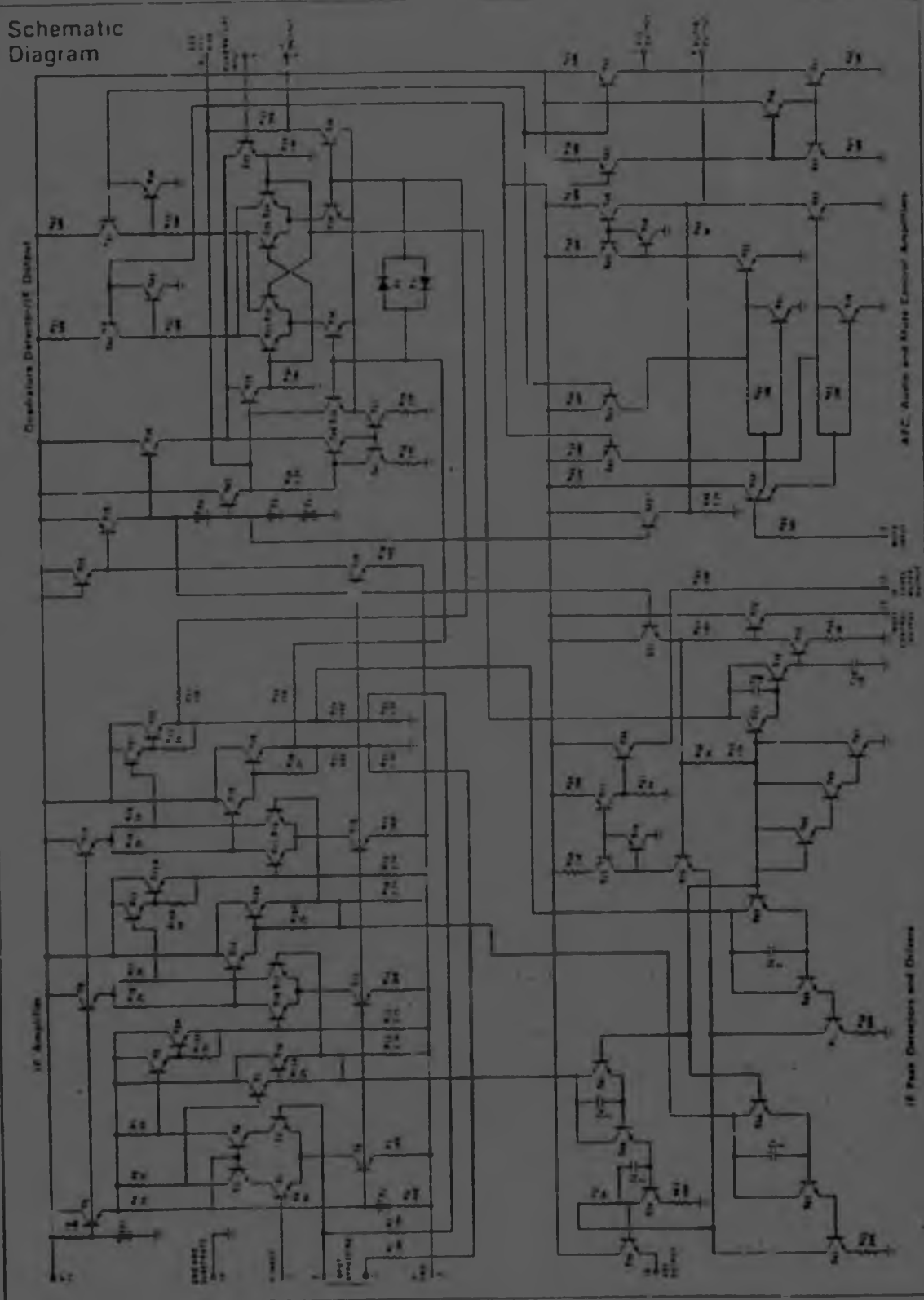

Typical Performance Characteristics (Continued)

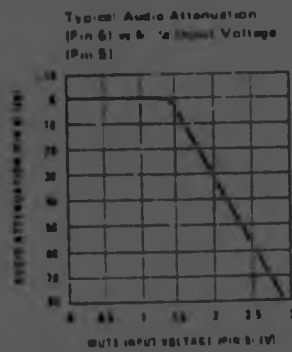
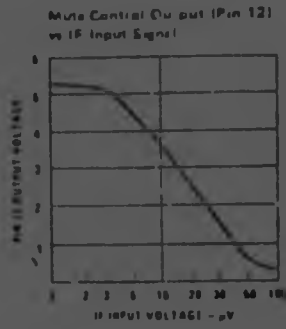
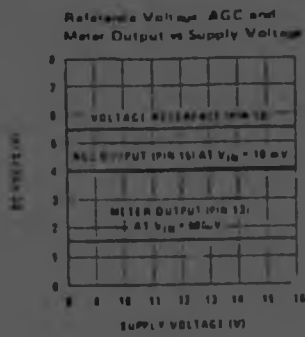
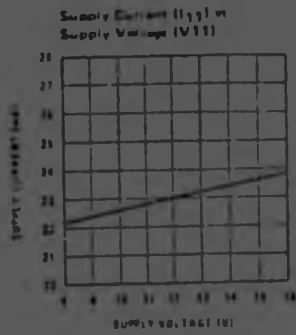

AC/DC Test Circuit

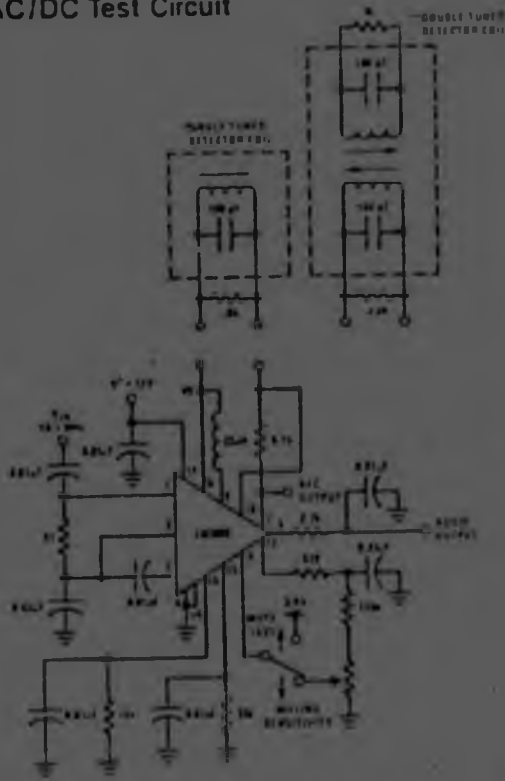

- * For single tuned detector coil
 L_0 tunes with 100 pF at 10.7 MHz
 Q_{UL} (unloaded) = 75
 Q_L (loaded) = 13 for $V_9 = 150$ mVrms
- ** For double tuned detector coil
 $Q_{ULPRI} = Q_{ULSEC} = 75$
 $s_0 = 0.7$ for $V_9 = 150$ mVrms

Note:
 The recovered audio output voltage will be approximately 0.5 dB less when using the double tuned detector coil.
 For proper operation of the mute circuit, the RF voltage at pin 9 should be 150 mVrms (30 mV).



Polycarbonate Film and Foil Capacitors cast resin sealed

Description

Polycarbonate film and extended foil electrode capacitors encapsulated under vacuum. Good attenuation, high resonant frequency and low loss angle. Suitable for high frequency low resistance circuits. Long stability with excellent moisture resistance. Close tolerances available. Rated voltages up to 1000 Vd.c./300 Va.c.

For special requirements in any application

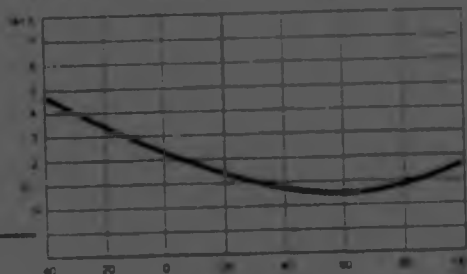
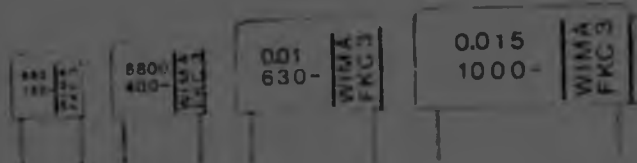

Power factor change with temperature

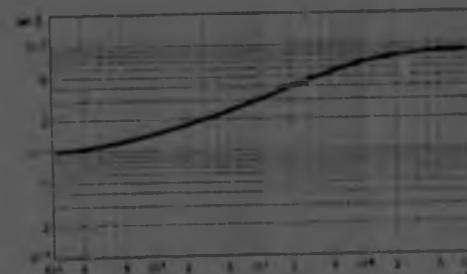

Power factor change with frequency

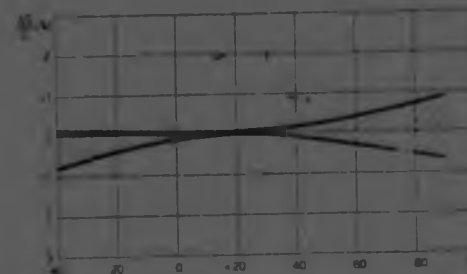

Capacitance change with temperature (f = 1 kHz)

Technical Data

Dielectric: Polycarbonate film
 Capacitor electrodes: Aluminium foil
 Encapsulation: Epoxy resin sealed under vacuum (yellow colour).
 Class of application: FMD in accordance with DIN 40 040.
 Temperature range: -55° C to +100° C
 Test specifications: In accordance with DIN 41 380, sheet 2
 Test category: 55/100/56 in accordance with DIN 40 045
 Insulation resistance at +20° C
 Capacitance $\leq 0.02 \mu\text{F}$: 5×10^8 megohms
 Capacitance $> 0.02 \mu\text{F}$: 10,000 sec (megohms $\times \mu\text{F}$)
 Mean values
 Minimum values in accordance with DIN 41 380, sheet 2
 Power factor: $\tan \delta = 1$ to 2×10^{-3} at 1 kHz and +20° C
 Capacitance tolerance: $\pm 20\%$ standard, special tolerances available
 Temperature coefficient: See graph
 Test voltage: 2.5 Vr, 2 sec.
 Voltage derating: A voltage derating factor of 1% per degree C must be applied from +85° C for DC voltages and from +75° C for AC voltages

Maximum pulse rise time

160 VDC	400 VDC	630 VDC	1000 VDC
100 V/microsecond		250 V/microsecond	

Capacitance long-term stability: $< \pm 1\%$ for the temperature range -25° C to +85° C

Safe contacts, low damping

The capacitors are impermeable to liquids and can be washed in commercial grade cleaning agents

German Federal Patent No. 1 764 852.

Radial lead capacitors of larger body size can be arranged to advantage in a horizontal position along the surface of p.c. boards and be secured safely by dip-coating them with lacquer.

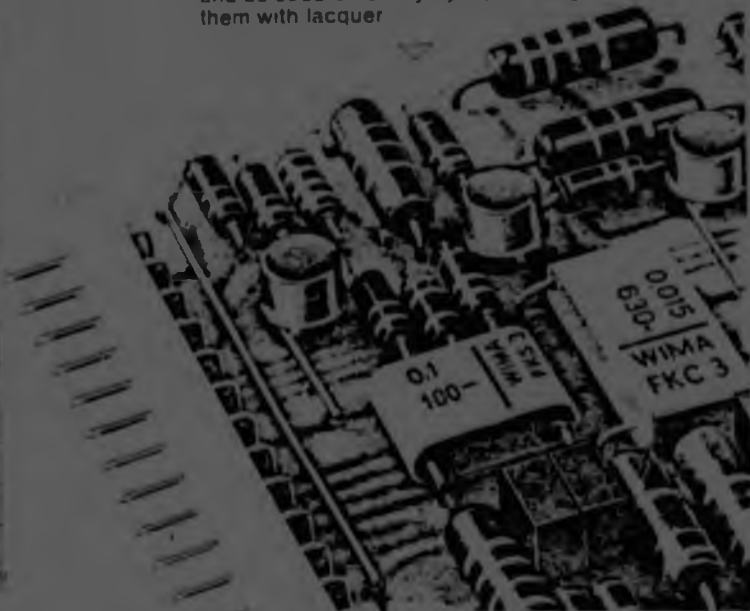

WIMA FKC 3

General Data

Capacitance	160 VDC/100 VAC*				400 VDC/250 VAC*				630 VDC/300 VAC*				1000 VDC/300 VAC*			
	W	H	L	PCM**	W	H	L	PCM**	W	H	L	PCM**	W	H	L	PCM**
100 pF	3	8.5	10	7.5	3	8.5	12.5	10								
150 .	3	8.5	10	7.5	3	8.5	12.5	10								
220 .	3	8.5	10	7.5	3	8.5	12.5	10								
330 .	3	8.5	10	7.5	3	8.5	12.5	10								
470 .	3	8.5	10	7.5	3	8.5	12.5	10								
680 .	3	8.5	10	7.5	3	8.5	12.5	10								
1000 pF	3	8.5	10	7.5	3	8.5	12.5	10					4	9.5	12.5	10
1500 .	3	8.5	10	7.5	3	8.5	12.5	10					4	12	19	15
2200 .	3	8.5	10	7.5	3	8.5	12.5	10					4	12	19	15
3300 .	3	8.5	10	7.5	3	8.5	12.5	10					4	12	19	15
4700 .	4	9.5	10	7.5	4	9.5	12.5	10					5	13	19	15
6800 .	4	9.5	10	7.5	5	11	12.5	10								
0.01 µF	4	9.5	12.5	10	6	12	12.5	10	6	12	12.5	10	6	14	19	15
0.015 .	4	9.5	12.5	10	4	12	19	15	5	13	19	15				
0.022 .	5	11	12.5	10	5	13	19	15	6	14	19	15				
0.033 .	6	12	12.5	10	6	14	19	15	5	14	27.5	22.5				
0.047 .	4	12	19	15	7	15	19	15	6	15	27.5	22.5				

Dims. in mm

* AC voltage: $f = 400 \text{ Hz}$; $1.4 \times V_{rms} + V_{d.c.} \leq V_{d.c.} \text{ (rated)}$
 ** PCM = Printed circuit module = lead spacing

Rights reserved to amend design data without prior notification

$d = 0.7 \phi$ if $PCM \geq 10$
 $d = 0.8 \phi$ if $PCM \geq 15$

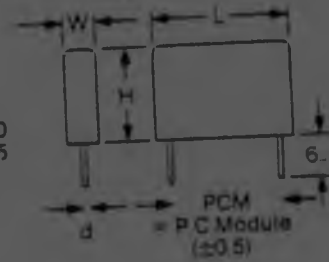

Permissible AC voltages in relation to frequency

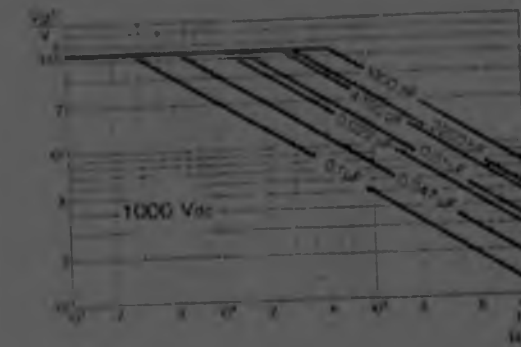
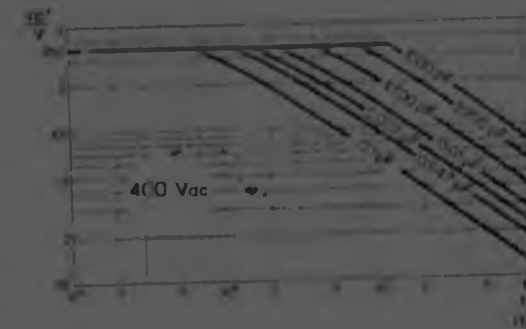
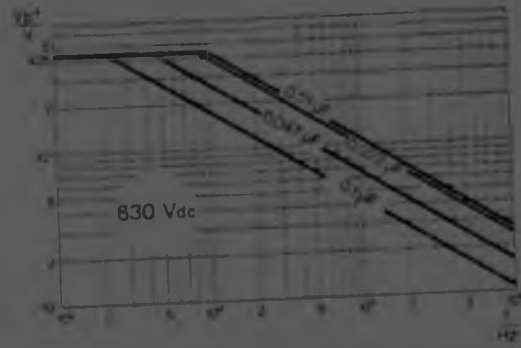
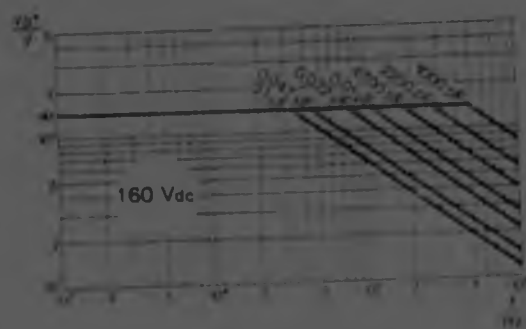

$V_{pp} = 2 \times V_{rms}$ (for sinusoidal AC voltages)

APPENDIX 8LOOP ANTENNA DETAILS

Since frequency modulation (FM) was used in all instances, the bandwidth of the antenna was not found to be critical (loops are generally fairly high Q circuits) since if the bandwidth was narrower than the bandwidth required by the modulated signal, it merely amplitude modulated the signal. The amplitude modulation component is rejected by the limiter in the FM demodulator (in the receiver).

Thus all that was important was to ensure that the loop antenna was resonant at the correct frequency and that the impedance was matched to that of the transmitter output or receiver input.

In the case of the loop antennas used for the monorail control system (both "body loop" size) the matching circuit shown in figure A8.1 was used.

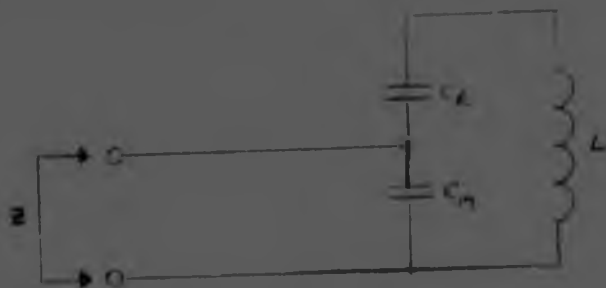

Loop Antenna and Matching Circuits

Figure A8.1.

In the figure A8.1.

- C_R = resonant capacitor
- C_m = matching capacitor
- L = loop antenna (an inductance)

The following formulae apply

$$C_m = \frac{1}{2\pi f X_L} \sqrt{\frac{C_D}{Z}}$$

and

$$C_R = \frac{1}{2\pi f X_L \left(1 - \sqrt{\frac{Z}{Z_D}}\right)}$$

where f = desired frequency of resonance

Z_D = dynamic impedance measured across an LC circuit consisting of the loop and a capacitor which will allow it to resonate at the desired frequency.

Z = impedance to which the loop must be matched.

X_L = inductive reactance of the loop at the desired frequency.

The procedure used to match the antenna was the following:

- 1) The inductive reactance (X_L) of the loop was measured (at the desired frequency) using a vector impedance meter.
- 2) A capacitor having the same capacitive reactance (X_C) was selected.
- 3) This capacitor was connected in parallel with the loop and dynamic impedance (Z_D) at resonance was measured with the vector impedance meter.
- 4) The formulae, given above, were then used to determine the values of the two capacitors required.

This matching circuit was also used with the small loop antenna built into the lid of the impact ripper control system transmitter.

In the case of the ferrite rod loop antenna used on the impact ripper control system, this matching circuit was found unsatisfactory. This was due to the fact that with this method of matching, a series resonant frequency occurs at a lower frequency than the parallel resonant frequency.

In the case of the ferrite rods used, the two resonant frequencies are very close together and tend to react with each other producing a very non-symmetrical frequency response. As a result, matching was very difficult, and the impedance was not stable.

The matching method shown in figure A 8.2. performed very satisfactorily.

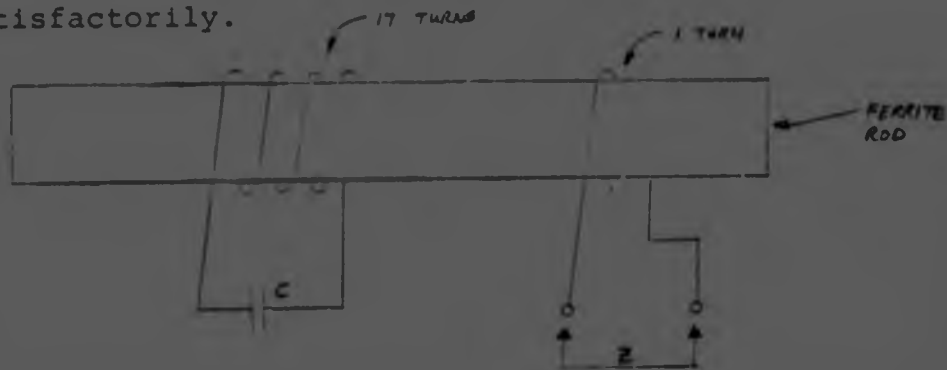

C was chosen to resonate with the 17 turn winding at the desired frequency. By adjustment of the position of the 1 turn matching winding, the output impedance Z could be easily adjusted to match the receiver input ($50\ \Omega$).

---o0o---

11
12

Author Robson H V

Name of thesis Aspects of Remote Control by Radio in gold Mines 1982

PUBLISHER:

University of the Witwatersrand, Johannesburg

©2013

LEGAL NOTICES:

Copyright Notice: All materials on the University of the Witwatersrand, Johannesburg Library website are protected by South African copyright law and may not be distributed, transmitted, displayed, or otherwise published in any format, without the prior written permission of the copyright owner.

Disclaimer and Terms of Use: Provided that you maintain all copyright and other notices contained therein, you may download material (one machine readable copy and one print copy per page) for your personal and/or educational non-commercial use only.

The University of the Witwatersrand, Johannesburg, is not responsible for any errors or omissions and excludes any and all liability for any errors in or omissions from the information on the Library website.